

Digital Temperature Controller

E5DC/E5DC-B

(22.5 mm Wide, and DIN Track-mounting Type)

The E5DC Mounts to DIN Track and Is Ideal for Connections to HMIs and PLCs. It provides the Same Easy Operation and Advanced Performance as the Rest of the E5□C Series.

Models with Push-In Plus Terminal Blocks Added to Lineup.



* CSA conformance evaluation by UL.



22.5 mm Wide, and DIN Track-mounting Type Models with Push-In Plus Terminal Blocks E5DC-B

22.5 mm Wide, and DIN Track-mounting Type Models with Screw Terminal Blocks E5DC

- A slim body at 85 × 22.5 mm (D × W) that fits into narrow control panels and mounts to DIN Track.
- Removable terminal block for easy replacement to simplify maintenance.
- Select from models with screw terminal blocks and models with Push-In Plus terminal blocks for reduced wiring work.
- No need for power supply and communication line wiring when using connectors with Push-In Plus terminal blocks. (Maximum connectable units: 16)
- High-speed sampling at 50 ms for applications with high-speed temperature increases.
- Easy connections to a PLC with programless communications.
- Set up the Controller without wiring the power supply by connecting to the computer with a Communications Conversion Cable (sold separately). Setup is easy with the CX-Thermo (sold separately).
- Models are available with up to 2 auxiliary outputs and 1 event input to complete basic functions.
- A white PV display (height: 8.5 mm) is easy to read when setting up, checking alarms, and making settings in a control panel.

Refer to your OMRON website for the most recent information on applicable safety standards.

Refer to **Safety Precautions** on page 122.

Main I/O Functions

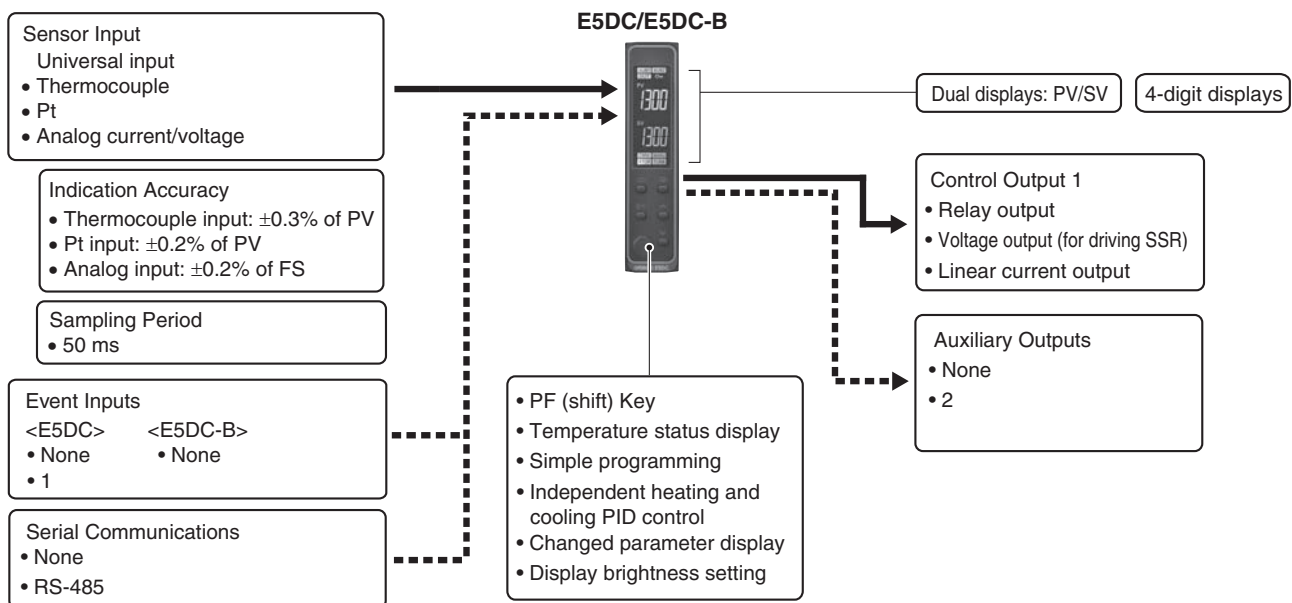

This datasheet is provided as a guideline for selecting products.

Be sure to refer to the following manuals for application precautions and other information required for operation before attempting to use the product.

E5□C Digital Temperature Controllers User's Manual (Cat. No. H174)

E5□C Digital Temperature Controllers Communications Manual (Cat. No. H175)

Model Number Legend and Standard Models

Model Number Legend

Models with Screw Terminal Blocks

E5DC-□□ □ □ □ M -□□□ (Example: E5DC-RX0ASM-015)

① ② ③ ④ ⑤ ⑥

Model	①	②	③	④	⑤	⑥	Meaning				
	Control outputs 1 and 2	No. of auxiliary outputs	Power supply voltage	Terminal type	Input type	Options					
E5DC							22.5 mm wide and mounts to DIN Track				
							Control output 1		Control output 2		
	RX						Relay output		None		
	QX						Voltage output (for driving SSR)		None		
*1	CX						Linear current output *1		None		
		0					None				
		2					2 (one common)				
			A				100 to 240 VAC				
			D				24 VAC/DC				
				S			Screw terminal blocks (Main Unit and Terminal Unit together)				
				U			Main Unit only (no Terminal Unit)				
					M		Universal input				
							HB alarm and HS alarm		Communications	Event input	
					*2	000	---		---	---	
					*3	002	1		RS-485	---	
					*4	015	---		RS-485	---	
					*5	016	---		---	1	
					*3	017	1		---	1	

*1. The control output can be used as a simple transfer output for the Digital Temperature Controllers manufactured in July 2014 or later.

*2. Option 000 can be selected only if two auxiliary outputs are selected.

*3. Options 002 and 017 can be selected only if the control output is a relay output or voltage output and two auxiliary outputs are selected.

*4. Option 015 cannot be selected if the control output is a relay output or voltage output and two auxiliary outputs are selected.

*5. Options 016 can be selected only if the control output is a linear current output and two auxiliary outputs are selected.

Heating and Cooling Control

Using Heating and Cooling Control

① Control Output Assignment

An auxiliary output is used as the cooling control output.

② Control

If PID control is used, you can set PID control separately for heating and cooling.

This allows you to handle control systems with different heating and cooling response characteristics.

List of Models

Control output	No. of auxiliary outputs	Options			Model				
		HB alarm and HS alarm	No. of event inputs	Communications	Power supply voltage 100 to 240 VAC	Power supply voltage 24 VAC/DC			
Relay output	---	---	---	RS-485	E5DC-RX0ASM-015	E5DC-RX0DSM-015			
				---	---	E5DC-RX0AUM-015	E5DC-RX0DUM-015		
						2	Detection for single-phase heater	1	---
	---	E5DC-RX2AUM-000	E5DC-RX2DUM-000						
	---	E5DC-RX2ASM-002	E5DC-RX2DSM-002						
	Voltage output (for driving SSR)	---	---	---	RS-485	E5DC-RX2AUM-002	E5DC-RX2DUM-002		
2					Detection for single-phase heater	1	---	E5DC-RX2ASM-017	E5DC-RX2DSM-017
							---	E5DC-RX2AUM-017	E5DC-RX2DUM-017
		---	E5DC-QX0ASM-015	E5DC-QX0DSM-015					
Linear current output		---	---	---	RS-485	E5DC-QX0AUM-015	E5DC-QX0DUM-015		
					2	---	---	---	E5DC-QX2ASM-000
	---							E5DC-QX2AUM-000	E5DC-QX2DUM-000
	---	E5DC-QX2ASM-002	E5DC-QX2DSM-002						
	Linear current output	2	---	1	---	E5DC-QX2AUM-002	E5DC-QX2DUM-002		
					---	E5DC-QX2ASM-017	E5DC-QX2DSM-017		
---					E5DC-QX2AUM-017	E5DC-QX2DUM-017			
2		---	1	---	E5DC-CX0ASM-015	E5DC-CX0DSM-015			
				---	E5DC-CX0AUM-015	E5DC-CX0DUM-015			
				---	E5DC-CX2ASM-000	E5DC-CX2DSM-000			
2	---	1	---	E5DC-CX2AUM-000	E5DC-CX2DUM-000				
			---	E5DC-CX2ASM-015	E5DC-CX2DSM-015				
			---	E5DC-CX2AUM-015	E5DC-CX2DUM-015				
2	---	1	---	E5DC-CX2ASM-016	E5DC-CX2DSM-016				
			---	E5DC-CX2AUM-016	E5DC-CX2DUM-016				
			---	E5DC-CX2ASM-016	E5DC-CX2DSM-016				

Model Number Legend

Models with Push-In Plus Terminal Blocks

E5DC-□□ □□ B M-□□□□ (Example: E5DC-QX2ABM-002)

① ② ③ ④ ⑤ ⑥

Model	①	②	③	④	⑤	⑥	Meaning	
	Control outputs 1 and 2	No. of auxiliary outputs	Power supply voltage	Terminal type	Input type	Options	Control output 1	Control output 2
E5DC							22.5 mm wide and mounts to DIN Track	
*1	RX						Relay output	None
	QX						Voltage output (for driving SSR)	None
	CX						Linear current output *1	None
		0					None	
		2					2 (one common)	
			A				100 to 240 VAC	
			D				24 VAC/DC	
				B			Push-In Plus Terminal Blocks	
					M		Universal input	
							HB alarm and HS alarm	Communications
*2	000					---	---	
*3	002					1	RS-485	
*4	015					---	RS-485	

*1. The control output can be used as a simple transfer output for the Digital Temperature Controllers manufactured in July 2014 or later.

*2. Option 000 can be selected only if two auxiliary outputs are selected.

*3. Options 002 and 017 can be selected only if the control output is a relay output or voltage output and two auxiliary outputs are selected.

*4. Option 015 cannot be selected if the control output is a relay output or voltage output and two auxiliary outputs are selected.

Heating and Cooling Control

Using Heating and Cooling Control

① Control Output Assignment

An auxiliary output is used as the cooling control output.

② Control

If PID control is used, you can set PID control separately for heating and cooling.

This allows you to handle control systems with different heating and cooling response characteristics.

List of Models

Control output	No. of auxiliary outputs	Options		Model	
		HB alarm and HS alarm	Communications	Power supply voltage 100 to 240 VAC	Power supply voltage 24 VAC/DC
Relay output	2	---	---	E5DC-RX2ABM-000	E5DC-RX2DBM-000
		Detection for single-phase heater	RS-485	E5DC-RX2ABM-002	E5DC-RX2DBM-002
	---	---	---	E5DC-RX0ABM-015	E5DC-RX0DBM-015
Voltage output (for driving SSR)	2	---	---	E5DC-QX2ABM-000	E5DC-QX2DBM-000
		Detection for single-phase heater	RS-485	E5DC-QX2ABM-002	E5DC-QX2DBM-002
	---	---	---	E5DC-QX0ABM-015	E5DC-QX0DBM-015
Linear current output	2	---	---	E5DC-CX2ABM-000	E5DC-CX2DBM-000
	---	---	---	E5DC-CX0ABM-015	E5DC-CX0DBM-015
	2	---	RS-485	E5DC-CX2ABM-015	E5DC-CX2DBM-015

Optional Products (Order Separately)

Terminal Unit

Model
E5DC-SCT1S

Push-In Plus Terminal Unit

Model
E5DC-SCT1B

USB-Serial Conversion Cable

Model
E58-CIFQ2

Communications Conversion Cable

Model
E58-CIFQ2-E

Note: Always use this product together with the E58-CIFQ2.
This Cable is used to connect to the front-panel Setup Tool port.

Current Transformers (CTs)

Hole diameter	Model
5.8 mm	E54-CT1
5.8 mm	E54-CT1L*
12.0 mm	E54-CT3
12.0 mm	E54-CT3L*

*Lead wires are included with these CTs. If UL certification is required, use these CTs.

Mounting Adapter

Model
Y92F-53 (2pcs)

Short Bars (for E5DC)

Model
Y92S-P11 (4 pcs)

CX-Thermo Support Software

Model
EST2-2C-MV4

Note: CX-Thermo version 4.6 or higher is required for the E5DC.
CX-Thermo version 4.69 or higher is required for the E5DC-B.
For the system requirements for the CX-Thermo, refer to information on the EST2-2C-MV4 on the OMRON website (www.ia.omron.com).

End Plate

Model
PFP-M

Spacer

Model
PFP-S

DIN Tracks

Model
PFP-100N
PFP-50N

Unit Labels

Model
Y92S-L2

End Cover

Model
Y92F-54

Connector Cover (for E5DC-B)

Model
E53-COV26

E5DC/E5DC-B

Specifications

Ratings

Power supply voltage	A in model number: 100 to 240 VAC, 50/60 Hz D in model number: 24 VAC, 50/60 Hz; 24 VDC	
Operating voltage range	85 to 110% of rated supply voltage	
Power consumption	4.9 VA max. at 100 to 240 VAC, and 2.8 VA max. at 24 VDC or 1.5 W max. at 24 VDC	
Sensor input	Temperature input Thermocouple: K, J, T, E, L, U, N, R, S, B, C/W, or PL II Platinum resistance thermometer: Pt100 or JPt100 Infrared temperature sensor (ES1B): 10 to 70°C, 60 to 120°C, 115 to 165°C, or 140 to 260°C Analog input Current input: 4 to 20 mA or 0 to 20 mA Voltage input: 1 to 5 V, 0 to 5 V, or 0 to 10 V	
Input impedance	Current input: 150 Ω max., Voltage input: 1 MΩ min. (Use a 1:1 connection when connecting the ES2-HB-N/THB-N.)	
Control method	ON/OFF control or 2-PID control (with auto-tuning)	
Control output	Relay output	SPST-NO, 250 VAC, 3 A (resistive load), electrical life: 100,000 operations, minimum applicable load: 5 V, 10 mA (reference value)
	Voltage output (for driving SSR)	Output voltage 12 VDC ±20% (PNP), max. Load current: 21 mA, with short-circuit protection circuit
	Linear current output	4 to 20 mA DC/0 to 20 mA DC, load: 500 Ω max., resolution: Approx. 10,000
Auxiliary output	Number of outputs	2 (depends on model)
	Output specifications	SPST-NO relay outputs: 250 VAC, 2 A (resistive load), Electrical life: 100,000 operations, Minimum applicable load: 10 mA at 5 V (reference value)
Event input *1	Number of inputs	1 (depends on model)
	External contact input specifications	Contact input ON: 1 kΩ max., OFF: 100 kΩ min.
		Non-contact input ON: Residual voltage 1.5 V max.; OFF: Leakage current 0.1 mA max. Current flow: approx. 7 mA per contact
Setting method	Digital setting using front panel keys	
Indication method	11-segment digital displays and individual indicators Character height: PV: 8.5 mm, SV: 8.0 mm	
Multi SP	Up to eight set points (SP0 to SP7) can be saved and selected using the event inputs, key operations, or serial communications. *2	
Bank switching	None	
Other functions	Manual output, heating/cooling control, loop burnout alarm, SP ramp, other alarm functions, heater burnout (HB) alarm (including SSR failure (HS) alarm), 40% AT, 100% AT, MV limiter, input digital filter, self tuning, robust tuning, PV input shift, run/stop, protection functions, extraction of square root, MV change rate limit, logic operations, temperature status display, simple programming, moving average of input value, display brightness setting, simple transfer output, *3 and work bit message *3	
Ambient operating temperature	-10 to 55°C (with no condensation or icing), For 3-year warranty: -10 to 50°C with standard mounting (with no condensation or icing)	
Ambient operating humidity	25 to 85%	
Storage temperature	-25 to 65°C (with no condensation or icing)	
Altitude	2,000 m max.	
Recommended fuse	T2A, 250 VAC, time-lag, low-breaking capacity	
Installation environment	Overvoltage category II, Pollution Degree 2 (EN/IEC/UL 61010-1)	

*1. This function is not supported by the E5DC-B. Refer to *Model Number Legend* on page 60.

*2. Only two set points are selectable for event inputs.

*3. Usage is possible for the Digital Temperature Controllers manufactured in July 2014 or later.

Input Ranges

Thermocouple/Platinum Resistance Thermometer (Universal inputs)

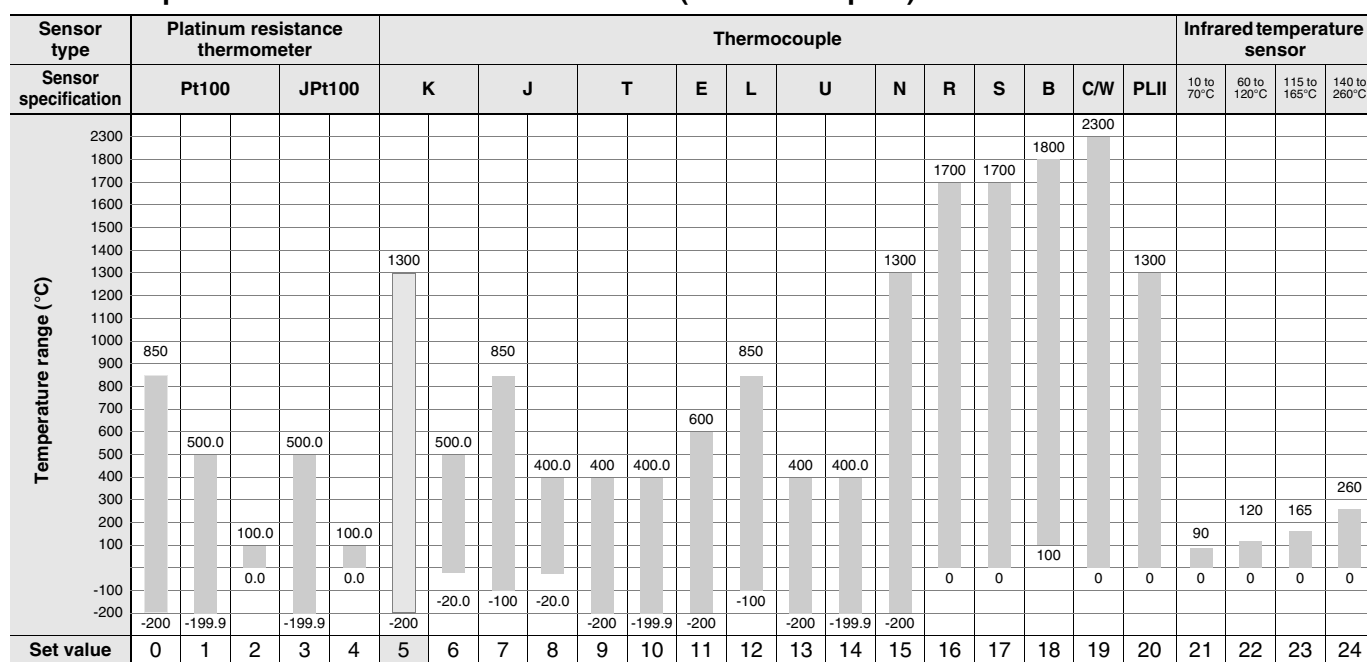

Shaded settings are the default settings.

The applicable standards for the input types are as follows:

K, J, T, E, N, R, S, B: JIS C 1602-2015, IEC 60584-1

JPt100: JIS C 1604-1989, JIS C 1606-1989

L: Fe-CuNi, DIN 43710-1985

Pt100: JIS C 1604-1997, IEC 60751

U: Cu-CuNi, DIN 43710-1985

PL II: According to Platinel II electromotive force charts from BASF (previously Engelhard)

C/W: W5Re/W26Re, JIS C 1602-2015, ASTM E988-1990

Analog input









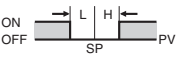

Input type	Current		Voltage		
Input specification	4 to 20 mA	0 to 20 mA	1 to 5 V	0 to 5 V	0 to 10 V
Setting range	Usable in the following ranges by scaling: -1999 to 9999, -199.9 to 999.9, -19.99 to 99.99 or -1.999 to 9.999				
Set value	25	26	27	28	29

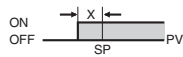
Alarm Types

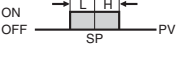
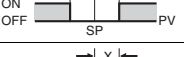
Each alarm can be independently set to one of the following 17 alarm types. The default is 2: Upper limit. (See note.)

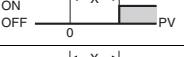
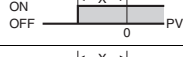
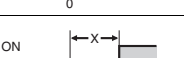
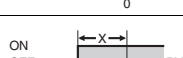
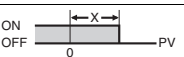
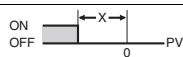
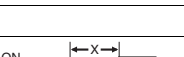
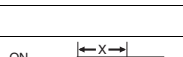
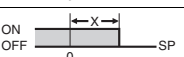
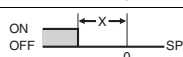
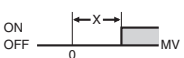
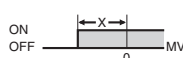
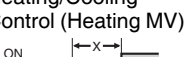
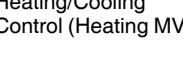
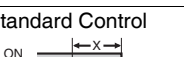
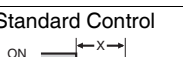
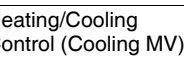
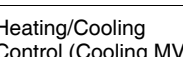
Auxiliary outputs are allocated to alarms. ON delays and OFF delays (0 to 999 s) can also be specified.

Note: In the default settings for models with HB or HS alarms, alarm 1 is set to a heater alarm (HA) and the Alarm Type 1 parameter is not displayed. To use alarm 1, set the output assignment to alarm 1.

Set value	Alarm type	Alarm output operation		Description of function
		When alarm value X is positive	When alarm value X is negative	
0	Alarm function OFF	Output OFF		No alarm
1	Upper- and lower-limit *1		*2	Set the upward deviation in the set point for the alarm upper limit (H) and the lower deviation in the set point for the alarm lower limit (L). The alarm is ON when the PV is outside this deviation range.
2 (default)	Upper-limit			Set the upward deviation in the set point by setting the alarm value (X). The alarm is ON when the PV is higher than the SP by the deviation or more.
3	Lower-limit			Set the downward deviation in the set point by setting the alarm value (X). The alarm is ON when the PV is lower than the SP by the deviation or more.
4	Upper- and lower-limit range *1		*3	Set the upward deviation in the set point for the alarm upper limit (H) and the lower deviation in the set point for the alarm lower limit (L). The alarm is ON when the PV is inside this deviation range.
5	Upper- and lower-limit with standby sequence *1	*5 	*4	A standby sequence is added to the upper- and lower-limit alarm (1). *6
6	Upper-limit with standby sequence			A standby sequence is added to the upper-limit alarm (2). *6
7	Lower-limit with standby sequence			A standby sequence is added to the lower-limit alarm (3). *6
8	Absolute-value upper-limit			The alarm will turn ON if the process value is larger than the alarm value (X) regardless of the set point.
9	Absolute-value lower-limit			The alarm will turn ON if the process value is smaller than the alarm value (X) regardless of the set point.
10	Absolute-value upper-limit with standby sequence			A standby sequence is added to the absolute-value upper-limit alarm (8). *6
11	Absolute-value lower-limit with standby sequence			A standby sequence is added to the absolute-value lower-limit alarm (9). *6
12	LBA (alarm 1 type only)	-		*7
13	PV change rate alarm	-		*8
14	SP absolute-value upper-limit alarm			This alarm type turns ON the alarm when the set point (SP) is higher than the alarm value (X).
15	SP absolute-value lower-limit alarm			This alarm type turns ON the alarm when the set point (SP) is lower than the alarm value (X).
16	MV absolute-value upper-limit alarm *9	Standard Control 	Standard Control 	This alarm type turns ON the alarm when the manipulated variable (MV) is higher than the alarm value (X).
		Heating/Cooling Control (Heating MV) 	Heating/Cooling Control (Heating MV) 	
		Always ON		
17	MV absolute-value lower-limit alarm *9	Standard Control 	Standard Control 	This alarm type turns ON the alarm when the manipulated variable (MV) is lower than the alarm value (X).
		Heating/Cooling Control (Cooling MV) 	Heating/Cooling Control (Cooling MV) 	
		Always ON		

*1. With set values 1, 4, and 5, the upper- and lower-limit values can be set independently for each alarm type, and are expressed as "L" and "H."

*2. Set value: 1, Upper- and lower-limit alarm

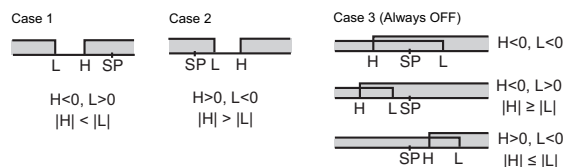

*3. Set value: 4, Upper- and lower-limit range

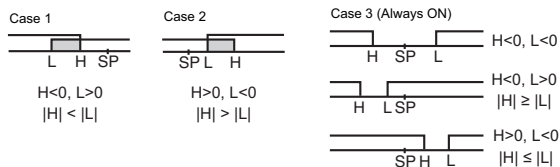

*4. Set value: 5, Upper- and lower-limit with standby sequence For Upper- and Lower-Limit Alarm Described Above at *2

- In cases 1 and 2 above, the alarm is always OFF if the upper- and lower-limit hysteresis overlaps.
- In case 3, the alarm is always OFF.

*5. Set value: 5, Upper- and lower-limit alarm with standby sequence The alarm is always OFF if upper- and lower-limit hysteresis overlaps.

*6. Refer to the *E5□C Digital Temperature Controllers User's Manual* (Cat. No. H174) for information on the operation of the standby sequence.

*7. Refer to the *E5□C Digital Temperature Controllers User's Manual* (Cat. No. H174) for information on the LBA.

*8. Refer to the *E5□C Digital Temperature Controllers User's Manual* (Cat. No. H174) for information on the PV change rate alarm.

*9. When heating/cooling control is performed, the MV absolute-value upper-limit alarm functions only for the heating operation and the MV absolute-value lower-limit alarm functions only for the cooling operation.

Characteristics

Indication accuracy (when mounted individually, ambient temperature of 23°C)		Thermocouple: (±0.3 % of indication value or ±1°C, whichever is greater) ±1 digit max.*1 Platinum resistance thermometer: (±0.2 % of indication value or ±0.8°C, whichever is greater) ±1 digit max. Analog input: ±0.2% FS ±1 digit max. CT input: ±5% FS ±1 digit max.
Simple transfer output accuracy		±0.3% FS max.*2
Influence of temperature *3		Thermocouple input (R, S, B, C/W, PL II): (±1% of indication value or ±10°C, whichever is greater) ±1 digit max. Other thermocouple input: (±1% of indication value or ±4°C, whichever is greater) ±1 digit max. *4
Influence of voltage *3		Platinum resistance thermometer: (±1% of indication value or ±2°C, whichever is greater) ±1 digit max. Analog input: ±1% FS ±1 digit max. CT input: ±5% FS ±1 digit max.
Influence of EMS. (at EN 61326-1)		
Installation influence (E5DC only)		R, S, B, W, or PLII thermocouple: (±1% of PV or ±10°C, whichever is greater) ±1 digit max. Other thermocouple: (±1% of PV or ±4°C, whichever is greater) ±1 digit max. *4
Input sampling period		50 ms
Hysteresis		Temperature input: 0.1 to 999.9°C or °F (in units of 0.1°C or °F) Analog input: 0.01% to 99.99% FS (in units of 0.01% FS)
Proportional band (P)		Temperature input: 0.1 to 999.9°C or °F (in units of 0.1°C or °F) Analog input: 0.1% to 999.9% FS (in units of 0.1% FS)
Integral time (I)		0 to 9999 s (in units of 1 s), 0.0 to 999.9 s (in units of 0.1 s) *5
Derivative time (D)		0 to 9999 s (in units of 1 s), 0.0 to 999.9 s (in units of 0.1 s) *5
Proportional band (P) for cooling		Temperature input: 0.1 to 999.9°C or °F (in units of 0.1°C or °F) Analog input: 0.1% to 999.9% FS (in units of 0.1% FS)
Integral time (I) for cooling		0 to 9999 s (in units of 1 s), 0.0 to 999.9 s (in units of 0.1 s) *5
Derivative time (D) for cooling		0 to 9999 s (in units of 1 s), 0.0 to 999.9 s (in units of 0.1 s) *5
Control period		0.1, 0.2, 0.5, 1 to 99 s (in units of 1 s)
Manual reset value		0.0% to 100.0% (in units of 0.1%)
Alarm setting range		-1,999 to 9,999 (decimal point position depends on input type)
Influence of signal source resistance		Thermocouple: 0.1°C/Ω max. (100 Ω max.), Platinum resistance thermometer: 0.1°C/Ω max. (10 Ω max.)
Insulation resistance		20 MΩ min. (at 500 VDC)
Dielectric strength		3,000 VAC, 50/60 Hz for 1 min between terminals of different charge
Vibration	Malfunction	10 to 55 Hz, 20 m/s ² for 10 min each in X, Y and Z directions
	Resistance	10 to 55 Hz, 20 m/s ² for 2 hr each in X, Y, and Z directions
Shock	Malfunction	100 m/s ² , 3 times each in X, Y, and Z directions
	Resistance	300 m/s ² , 3 times each in X, Y, and Z directions
Weight		Main unit: Approx. 80 g, Models with Screw Terminal Unit: Approx. 40 g, Models with Push-In Plus Terminal Unit: Approx. 40 g
Degree of protection		Main unit: IP20, Terminal unit: IP00
Memory protection		Non-volatile memory (number of writes: 1,000,000 times)
Setup Tool		CX-Thermo version 4.6 or higher
Setup Tool port		E5DC/E5DC-B bottom panel: An E58-CIFQ2 USB-Serial Conversion Cable is used to connect a USB port on the computer. *6 E5DC/E5DC-B front panel: An E58-CIFQ2 USB-Serial Conversion Cable and E58-CIFQ2-E Conversion Cable are used together to connect a USB port on the computer.*6
Standards	Approved standards	cULus: UL 61010-1/CSA C22.2 No.61010-1, Korean wireless regulations (Radio law: KC Mark) (Some models only.) *7, Lloyd's standards (E5DC only) *8, EAC
	Conformed standards	EN 61010-1 (IEC 61010-1), RCM
EMC		EMI: Radiated Interference Electromagnetic Field Strength: EN61326-1 *9 Noise Terminal Voltage: EN55011 Group 1, class A EN55011 Group 1, class A EMS: ESD Immunity: EN61326-1 *9 EN61000-4-2 Electromagnetic Field Immunity: EN61000-4-3 Burst Noise Immunity: EN61000-4-4 Conducted Disturbance Immunity: EN61000-4-6 Surge Immunity: EN61000-4-5 Voltage Dip/Interrupting Immunity: EN61000-4-11

*1. The indication accuracy of K thermocouples in the -200 to 1,300°C range, T and N thermocouples at a temperature of -100°C max., and U and L thermocouples at any temperature is ±2°C ±1 digit max. The indication accuracy of B thermocouples at a temperature of 400°C max. is not specified. The indication accuracy of B thermocouples at a temperature of 400 to 800°C is ±3°C max.

The indication accuracy of R and S thermocouples at a temperature of 200°C max. is ±3°C ±1 digit max. The indication accuracy of C/W thermocouples is (±0.3% of PV or ±3°C, whichever is greater) ±1 digit max.

The indication accuracy of PLII thermocouples is (±0.3% of PV or ±2°C, whichever is greater) ±1 digit max.

*2. However, the precision between 0 and 4 mA for a 0 to 20 mA output is ±1% FS max.

*3. Ambient temperature: -10°C to 23°C to 55°C, Voltage range: -15% to 10% of rated voltage

*4. K thermocouple at -100°C max.: ±10°C max.

*5. The unit is determined by the setting of the Integral/Derivative Time Unit parameter.

*6. External serial communications (RS-485) and USB-Serial Conversion Cable communications can be used at the same time.

*7. Refer to your OMRON website for the most recent information on applicable models.

*8. Refer to information on maritime standards in *Shipping Standards* on page 124 for compliance with Lloyd's Standards.

*9. Industrial electromagnetic environment (EN/IEC 61326-1 Table 2)

USB-Serial Conversion Cable

Applicable OS	Windows XP/Vista/7/8/10 *1
Applicable software	CX-Thermo version 4.6 or higher
Applicable models	E5□C-T Series, E5□C Series, and E5CB Series
USB interface standard	Conforms to USB Specification 2.0
DTE speed	38,400 bps
Connector specifications	Computer: USB (Type A plug) Digital Temperature Controller: Special serial connector
Power supply	Bus power (Supplied from the USB host controller) *2
Power supply voltage	5 VDC
Current consumption	450 mA max.
Output voltage	4.7±0.2 VDC (Supplied from USB-Serial Conversion Cable to the Digital Temperature Controller.)
Output current	250 mA max. (Supplied from USB-Serial Conversion Cable to the Digital Temperature Controller.)
Ambient operating temperature	0 to 55°C (with no condensation or icing)
Ambient operating humidity	10% to 80%
Storage temperature	-20 to 60°C (with no condensation or icing)
Storage humidity	10% to 80%
Altitude	2,000 m max.
Weight	Approx. 120 g

Windows is a registered trademark of Microsoft Corporation in the United States and/or other countries.

*1. CX-Thermo version 4.65 or higher runs on Windows 10.

*2. Use a high-power port for the USB port.

Note: A driver must be installed on the computer. Refer to the *Instruction Manual* included with the Cable for the installation procedure.

Communications Specifications

Transmission line connection method	RS-485: Multidrop
Communications	RS-485 (two-wire, half duplex)
Synchronization method	Start-stop synchronization
Protocol	CompoWay/F, or Modbus
Baud rate *	9,600, 19,200, 38,400, or 57,600 bps
Transmission code	ASCII
Data bit length *	7 or 8 bits
Stop bit length *	1 or 2 bits
Error detection	Vertical parity (none, even, odd) Block check character (BCC) with CompoWay/F or CRC-16 with Modbus
Flow control	None
Interface	RS-485
Retry function	None
Communications buffer	217 bytes
Communications response wait time	0 to 99 ms Default: 20 ms

* The baud rate, data bit length, stop bit length, and vertical parity can be individually set using the Communications Setting Level.

Communications Functions

Programless communications *1	You can use the memory in the PLC to read and write E5□C parameters, start and stop operation, etc. The E5□C automatically performs communications with PLCs. No communications programming is required. Number of connected Digital Temperature Controllers: 32 max. (Up to 16 for the FX Series) Applicable PLCs OMRON PLCs CS Series, CJ Series, CP Series, NJ Series, or NX1P Mitsubishi Electric PLCs MELSEC Q Series, L Series, FX3 Series, or iQ-R Series KEYENCE PLCs KEYENCE KV Series
--------------------------------------	--

Component Communications *1	When Digital Temperature Controllers are connected, set points and RUN/STOP commands can be sent from the Digital Temperature Controller that is set as the master to the Digital Temperature Controllers that are set as slaves. Slope and offsets can be set for the set point. Number of connected Digital Temperature Controllers: 32 max. (including master)
Copying *2	When Digital Temperature Controllers are connected, the parameters can be copied from the Digital Temperature Controller that is set as the master to the Digital Temperature Controllers that are set as slaves.

MELSEC is a registered trademark of Mitsubishi Electric Corporation.
KEYENCE is a registered trademark of Keyence Corporation.

*1. A Temperature Controller with version 2.1 or higher is required for the FX Series or the KV Series.

*2. Both the programless communications and the component communications support the copying.

Current Transformer (Order Separately) Ratings

	E54-CT1 E54-CT3	E54-CT1L E54-CT3L
Dielectric strength	1,000 VAC for 1 min	1,500 VAC for 1 min
Vibration resistance	50 Hz, 98 m/s ²	
Weight	E54-CT1: Approx. 11.5 g E54-CT3: Approx. 50 g	E54-CT1L: Approx. 14 g E54-CT3L: Approx. 57 g
Accessories	E54-CT3 Only Armatures (2) Plugs (2)	None

Heater Burnout Alarms and SSR Failure Alarms

CT input (for heater current detection)	Models with detection for single-phase heaters: One input
Maximum heater current	50 A AC
Input current indication accuracy	±5% FS ±1 digit max.
Heater burnout alarm setting range *1	0.1 to 49.9 A (in units of 0.1 A) Minimum detection ON time: 100 ms *3
SSR failure alarm setting range *2	0.1 to 49.9 A (in units of 0.1 A) Minimum detection OFF time: 100 ms *4

*1. For heater burnout alarms, the heater current will be measured when the control output is ON, and the output will turn ON if the heater current is lower than the set value (i.e., heater burnout detection current value).

*2. For SSR failure alarms, the heater current will be measured when the control output is OFF, and the output will turn ON if the heater current is higher than the set value (i.e., SSR failure detection current value).

*3. The value is 30 ms for a control period of 0.1 s or 0.2 s.

*4. The value is 35 ms for a control period of 0.1 s or 0.2 s.

Electrical Life Expectancy Curve for Control Output Relay (Reference Values)

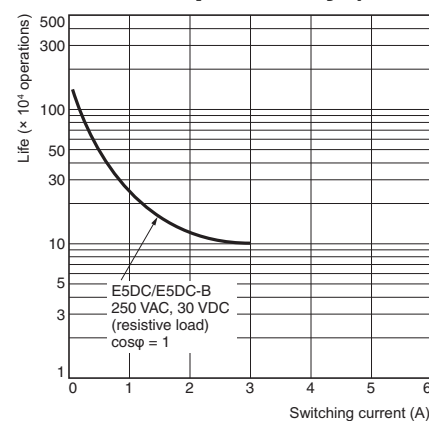

External Connections

E5DC (Models with Screw Terminal Blocks)

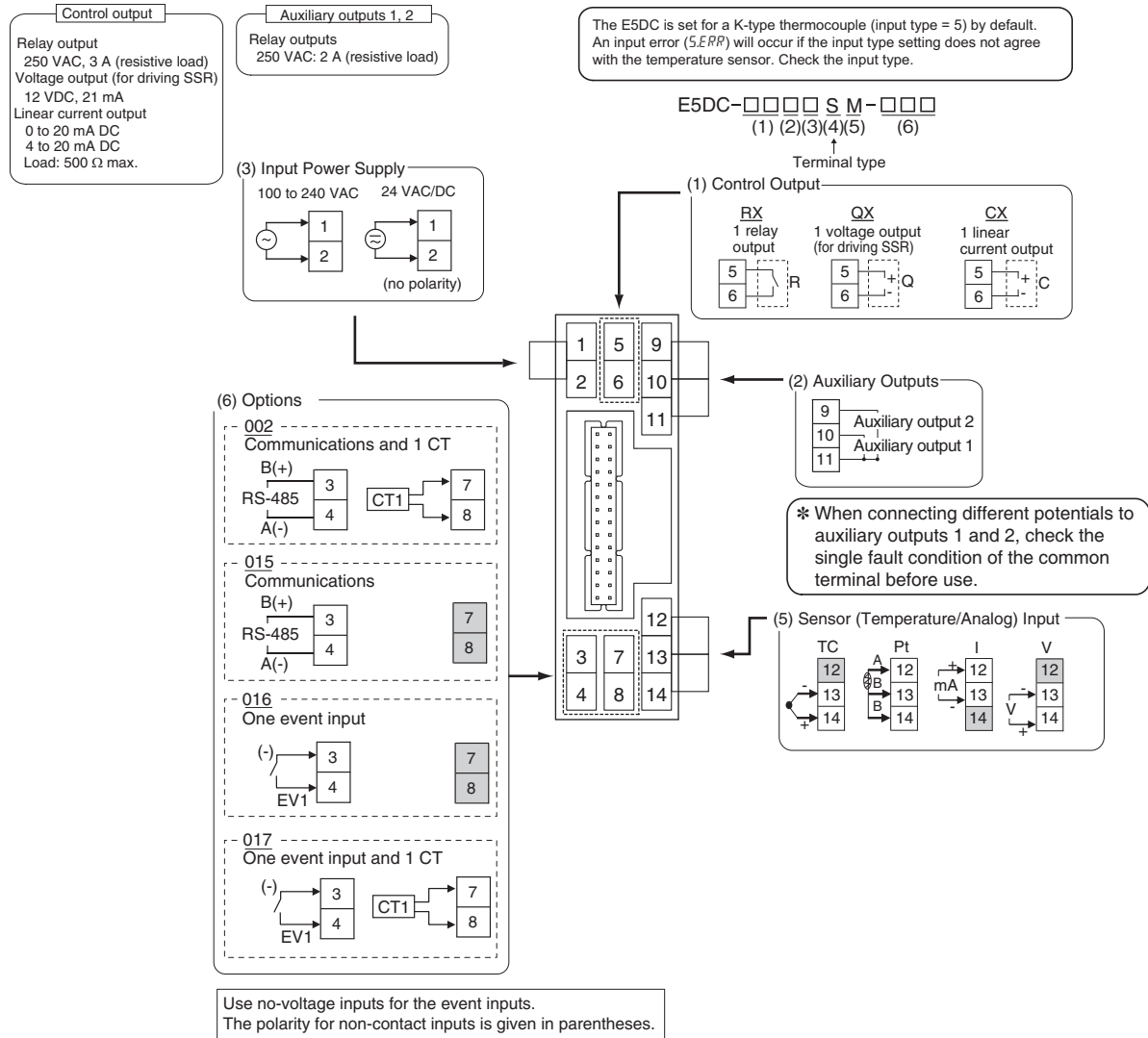

- Note:**
1. The application of the terminals depends on the model.
 2. Do not wire the terminals that are shown with a gray background.
 3. When complying with EMC standards, the cable that connects the sensor must be 30 m or less. If the cable length exceeds 30m, compliance with EMC standards will not be possible.
 4. Connect M3 crimped terminals.
 5. Due to UL Listing requirements, use the E54-CT1L or E54-CT3L Current Transformer with the factory wiring (internal wiring). Use a UL category XOBA or XOBA7 current transformer that is UL Listed for field wiring (external wiring) and not the factory wiring (internal wiring).
 6. The terminal layout is different than models with Push-In Plus terminal blocks. Check the terminal arrangement before wiring.

E5DC-B (Models with Push-In Plus Terminal Blocks)

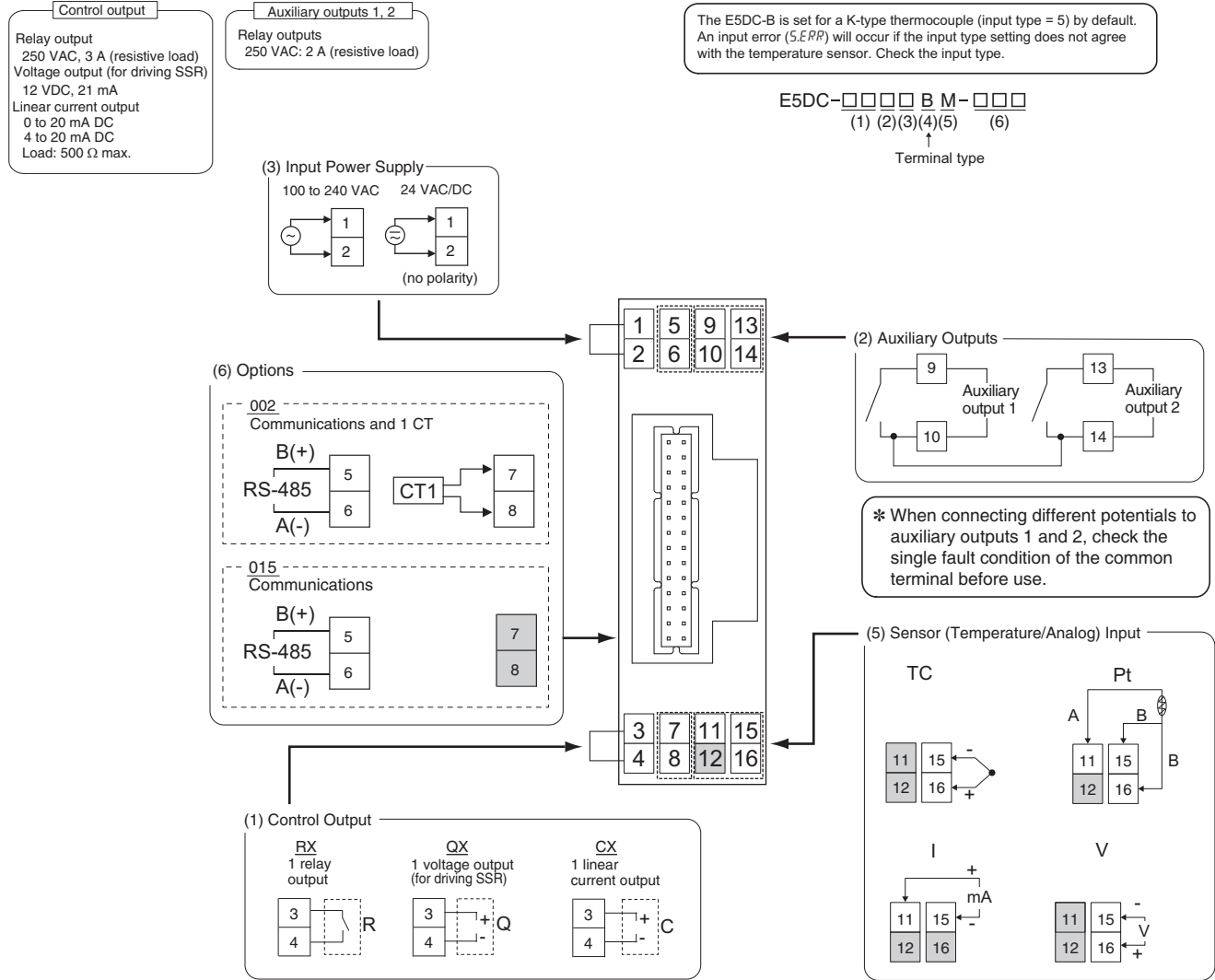

- Note:**
- The application of the terminals depends on the model.
 - Do not wire the terminals that are shown with a gray background.
 - When complying with EMC standards, the cable that connects the sensor must be 30 m or less. If the cable length exceeds 30m, compliance with EMC standards will not be possible.
 - Refer to Wiring Precautions for E5□C-B (Controllers with Push-In Plus Terminal Blocks) on page 133 for wire specifications and wiring methods.
 - Due to UL Listing requirements, use the E54-CT1L or E54-CT3L Current Transformer with the factory wiring (internal wiring). Use a UL category XOBA or XOBA7 current transformer that is UL Listed for field wiring (external wiring) and not the factory wiring (internal wiring).
 - The terminal layout is different than models with screw terminal blocks. Check the terminal arrangement before wiring.
 - The event input specification main unit is not used with models with Push-In Plus terminal blocks.

Isolation/Insulation Block Diagrams

E5DC

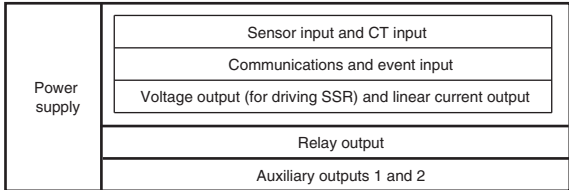

: Reinforced insulation
 : Functional isolation

Note: Auxiliary outputs 1 to 2 are not insulated.

E5DC-B

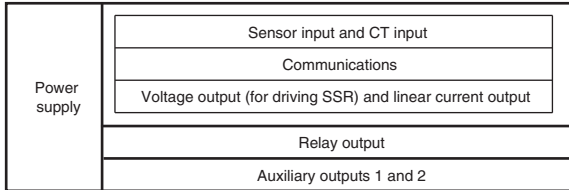

: Reinforced insulation
 : Functional isolation

Note: Auxiliary outputs 1 to 2 are not insulated.

E5DC/E5DC-B

Nomenclature

E5DC
E5DC-B

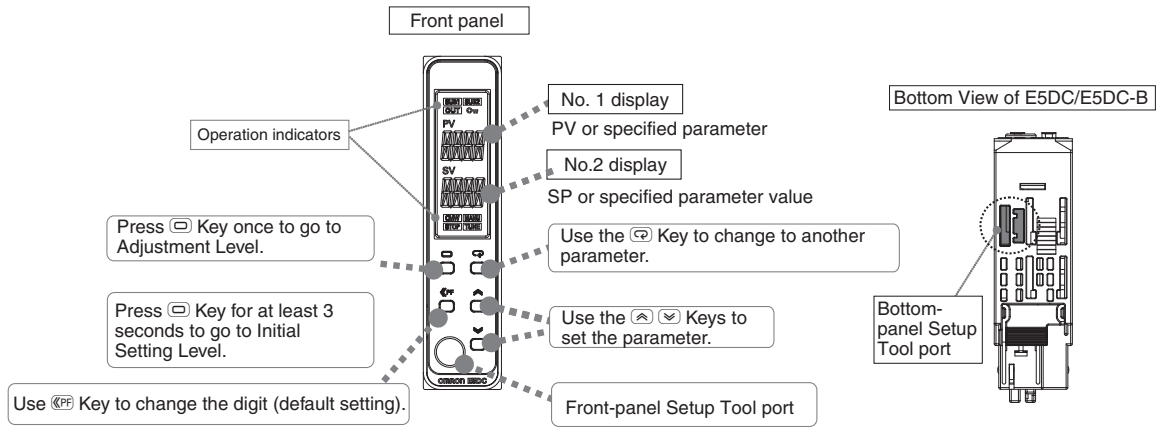

Dimensions

Controllers

E5DC



The above figure shows the Terminal Unit attached to the Main Unit.

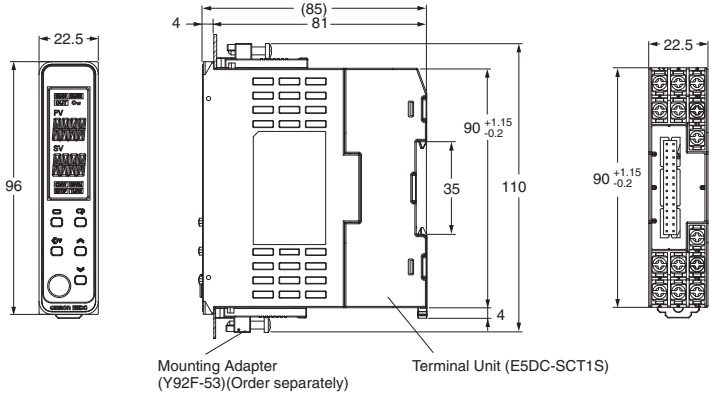

Mounting Adapter (Y92F-53)(Order separately) Terminal Unit (E5DC-SCT1S)

E5DC-B



The above figure shows the Push-In Plus Terminal Unit attached to the Main Unit.

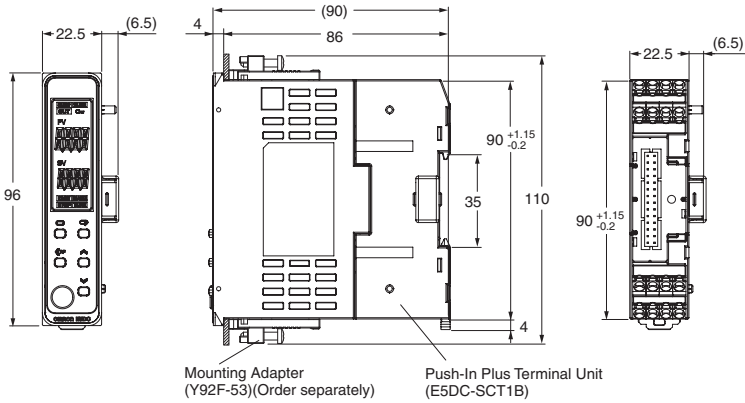

Mounting Adapter (Y92F-53)(Order separately) Push-In Plus Terminal Unit (E5DC-SCT1B)

- Setup Tool ports are provided as standard feature. Use these ports to connect a computer to the Digital Temperature Controller. The E58-CIFQ2 USB-Serial Conversion Cable is required to connect to the port on the bottom panel. The E58-CIFQ2 USB-Serial Conversion Cable and E58-CIFQ2-E Communications Conversion Cable are required to connect to the port on the front panel. (You cannot leave either port connected constantly during operation.)

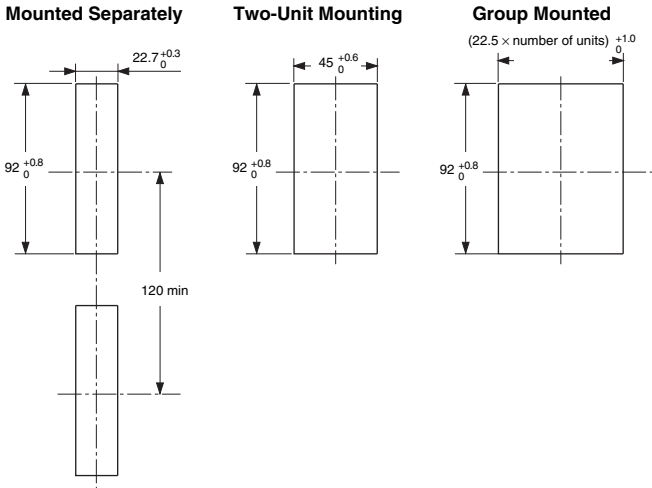

- Recommended panel thickness is 1 to 8 mm.
- Group mounting is not possible in the vertical direction. (Maintain the specified mounting space between Controllers.)
- When two or more Digital Temperature Controllers are mounted, make sure that the surrounding temperature does not exceed the allowable operating temperature specified in the specifications.

Accessories (Order Separately)

Terminal Unit E5DC-SCT1S

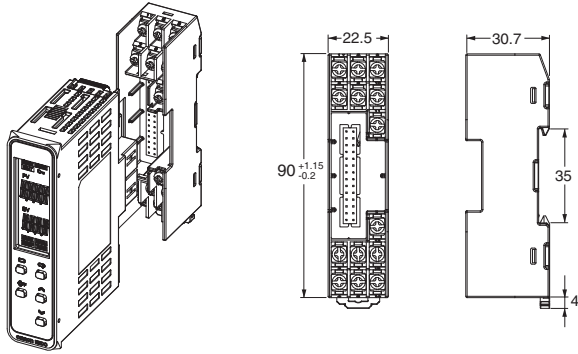

Push-In Plus Terminal Unit E5DC-SCT1B

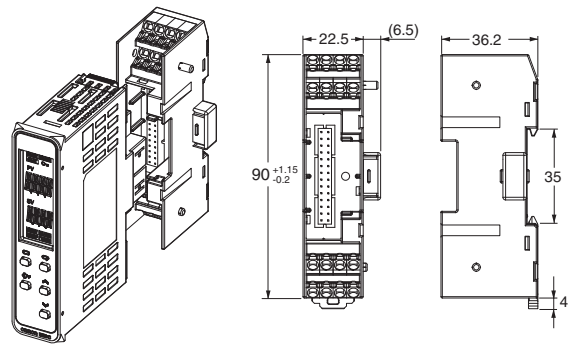

USB-Serial Conversion Cable E58-CIFQ2

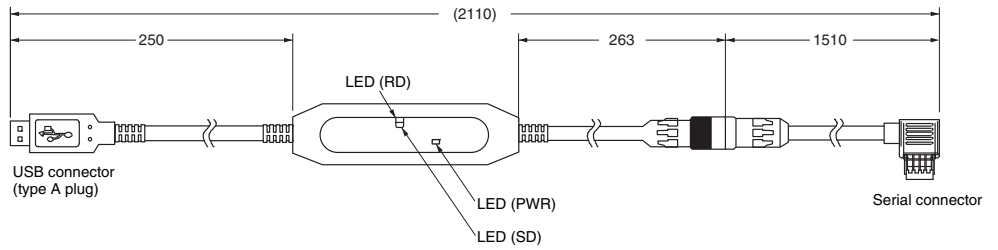

Conversion Cable E58-CIFQ2-E

Conversion Cable

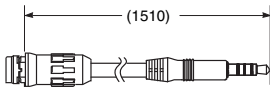

Connecting to the E58-CIFQ2 USB-Serial Conversion Cable

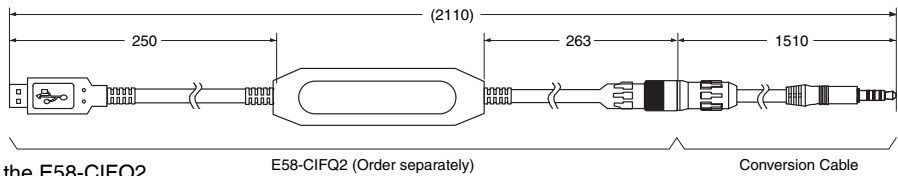

Note: Always use this product together with the E58-CIFQ2.

E54-CT3

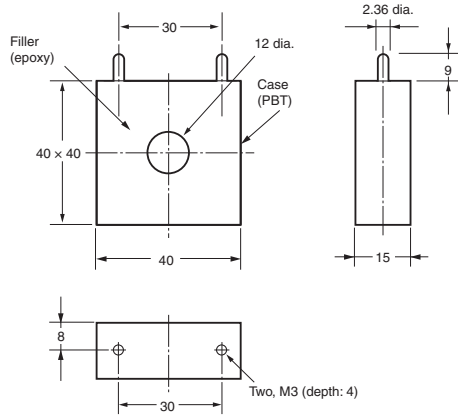

E54-CT3 Accessories

• Armature

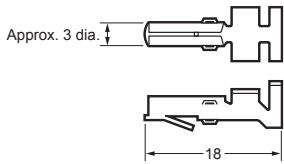

Connection Example

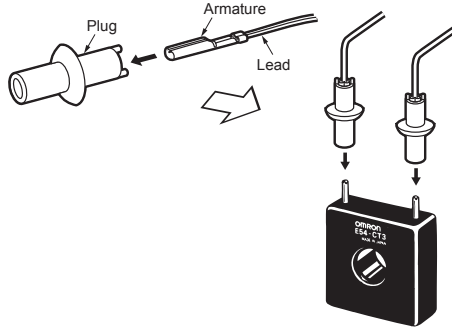

• Plug

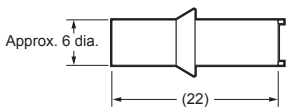

Thru-current (I_o) vs. Output Voltage (E_o) (Reference Values) E54-CT3 or E54-CT3L

Maximum continuous heater current: 120 A (50/60 Hz)
 (Maximum continuous heater current for an OMRON Digital Temperature Controller is 50 A.)

Number of windings: 400±2
 Winding resistance: 8±0.8 Ω

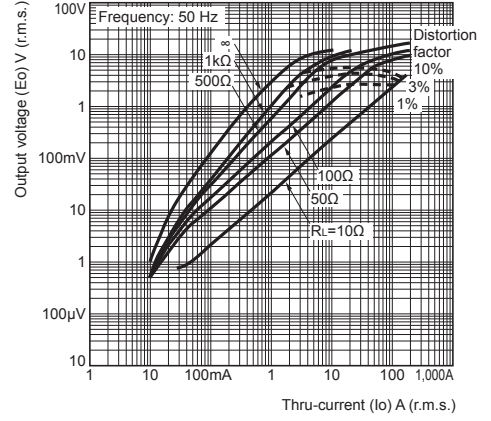

E54-CT3L

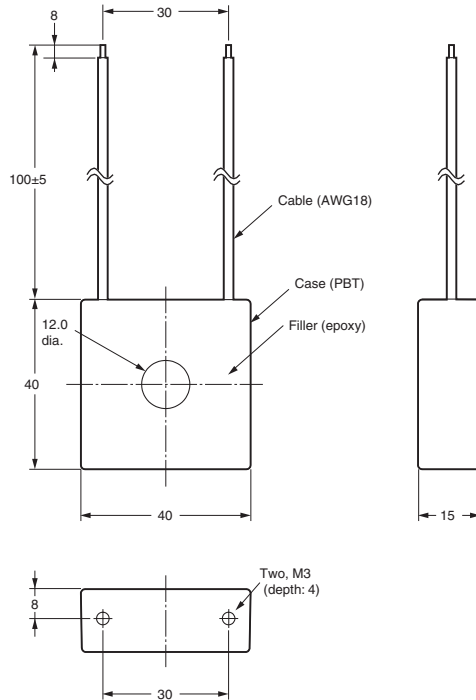

Mounting Adapters

Y92F-53 (Two included.)

This accessory is not included with the product. Order it separately to mount the product to a panel.

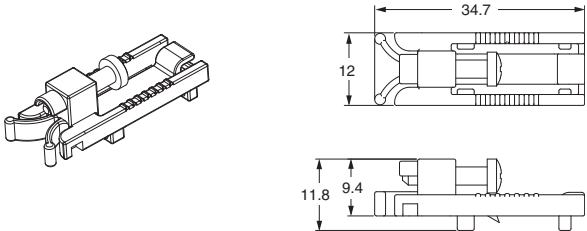

Short Bars

Y92S-P11 (Four included.)

Use this product to connect between terminals (for power supplies, communications, etc.) when you use multiple E5DC Controllers.

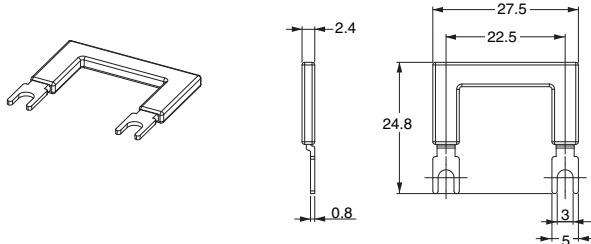

End Plate

PFP-M

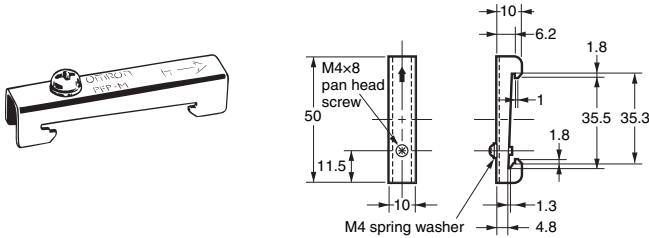

DIN Tracks

**PFP-100N
PFP-50N**

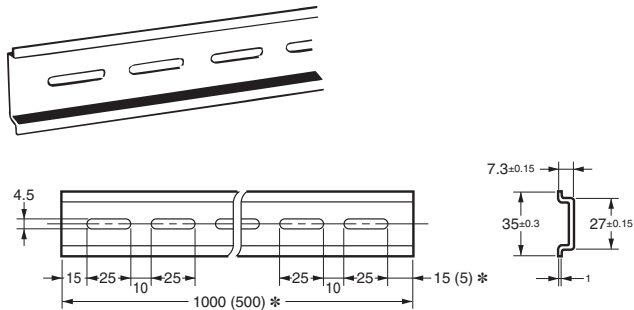

* Dimensions in parentheses are for the PFP-50N.

Spacer

PFP-S

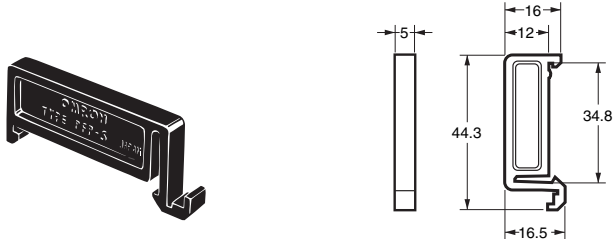

Unit Labels

Y92S-L2

V	A	V _A	%	J	Pa	Ω
s	/	N	m	W	°C	m ³ k
°F	g	min	mm	rpm		
VA	mV	mA	Hz			
m/min	OMRON					
OUT	OUT					

The Unit Labels for the Digital Panel Meter are used. Use either the °C or °F label from the sheet.

End Cover

Y92F-54 (Two included.)

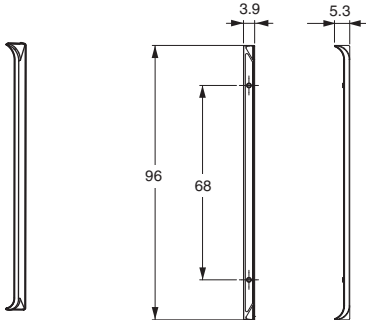

Use the End Cover when you mount the E5DC/E5DC-B to a panel to hide the gap between the Controller and the panel.

E5DC/E5DC-B

Connector Cover

E53-COV26

Male connector cover

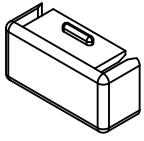

Female connector cover

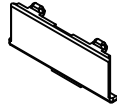

E5DC-B Push-In Plus Terminal Units are mounted with both a male and female connector cover (E53-COV26).
Order the connector cover separately if it becomes lost or damaged.
