

MODEL 15S – INCREMENTAL SHAFT ENCODER



Ø1.5"

FEATURES

- High Performance Economical Encoder
- Low Profile – Less Than 1.0" (25.4 mm) Height and 1.5" (38 mm) Diameter
- Extended Temperature Operating Ranges Available
- Up to 12 Pole Commutation Optional (for Brushless Motor Control)

The Model 15S Accu-Coder™ offers a high performance feedback solution in a low profile package, making the Model 15S ideal for commercial and light-duty industrial applications. This industry standard Size 15 (1.5" diameter) encoder features a precision bearing set, sealing available to IP64, a durable stainless steel shaft, and a selection of servo, flange, and face mount options. The Model 15S may also be specified with features such as extended operating temperatures from -40° C to 120° C, and up to 12 pole commutation for brushless motor control. The Model 15S features EPC's Opto-ASIC circuitry for a clean, reliable signal. Its durable yet economical design makes it an ideal encoder for high precision OEM applications.

COMMON APPLICATIONS

Servo Motor Control, Robotics, Medical Diagnostic Equipment, Specialty Assembly Machines, Digital Plotters, Printers, Typesetting Equipment

MODEL 15S ORDERING GUIDE

Blue type indicates price adder options. Not all configuration combinations may be available. Contact Customer Service for details.

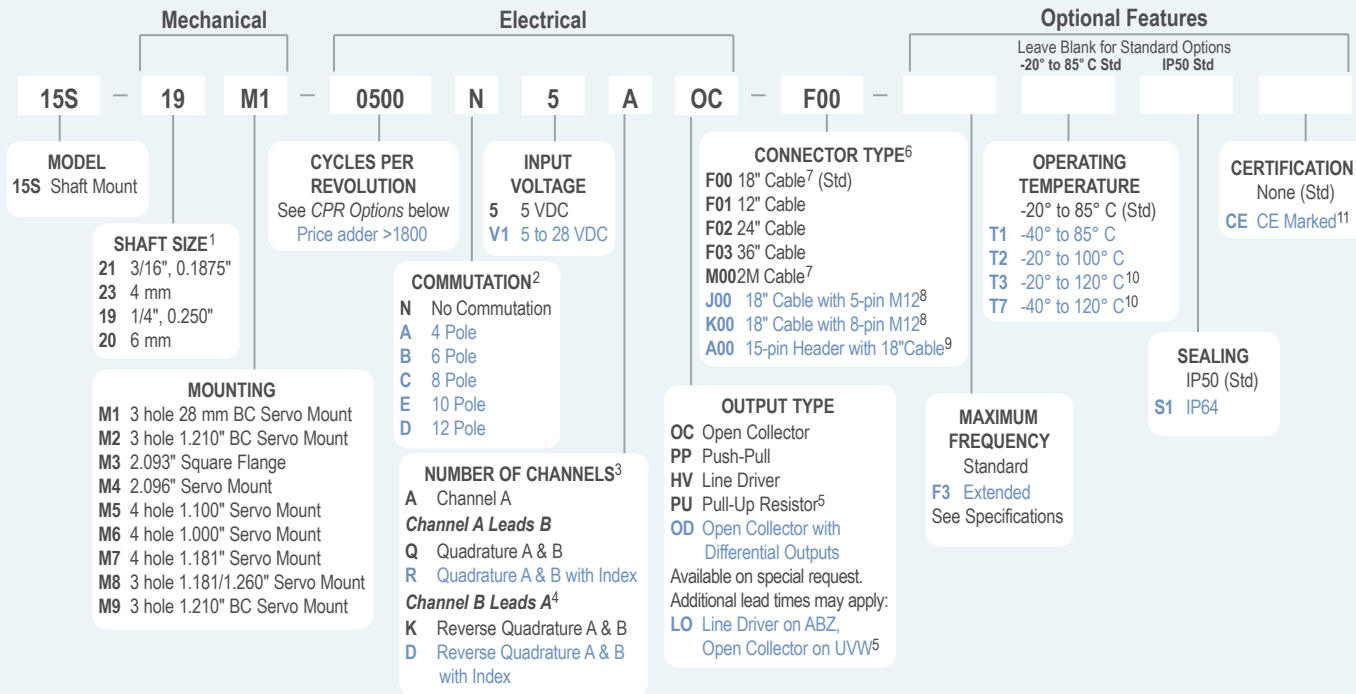

MODEL 15S CPR OPTIONS

0001 thru 0189*	0198	0200	0250	0256	0300
0315	0360	0400	0500	0512	0580
0750	0800	1000	1024	1200	1250
1800	2000	2048	2500	2540	3000
4000	4096	5000	6000	7200	8192
					10,000

New CPR values are periodically added to those listed. Contact Customer Service to determine all currently available values. Special disk resolutions are available upon request and may be subject to a one-time NRE fee.

NOTES:

- Contact Customer Service for additional options not shown.
- Not available in all configurations, and not available with V1 Input Voltage. Contact Customer Service for availability.
- Contact Customer Service for non-standard index gating or phase relationship options, or see Quadrature Phasing and Index Gating Options at encoder.com.
- Reverse Quadrature not available with PU output type.
- With Input Voltage above 16 VDC, operating temperature is limited to 85° C.
- For mating connectors, cables, and cordsets see [Accessories](#) at encoder.com. For Connector Pin Configuration Diagrams, see Technical Information or see [Connector Pin Configuration Diagrams](#) at encoder.com.
- For non-standard English cable lengths enter 'F' plus cable length expressed in feet. Example: F06 = 6 feet of cable. For non-standard metric cable lengths enter 'M' plus cable length expressed in meters. Example: M06 = 6 meters of cable. Frequency above 300 kHz standard cable lengths only.
- Not available with commutation. 5-pin not available with Line Driver (HV, OD, LO) outputs. Additional cable lengths available. Please contact Customer Service.
- Pin Header available with 5 VDC Input Voltage, HV Line Driver and standard quadrature phasing only. Not available with CE Certification. IP50 sealing option only.
- Only available with 5 VDC Input Voltage.
- Please refer to Technical Bulletin [TB100: When to Choose the CE Mark](#) at encoder.com.

MODEL 15S SPECIFICATIONS

Electrical

Input Voltage.....5 VDC $\pm 10\%$ Fixed Voltage
4.75 to 28 VDC max for temperatures up to 85° C
4.75 to 24 VDC for temperatures between 85° to 100° C

Input Current.....140 mA max (65 mA typical for most configurations) with no output load

Output Format.....Incremental – Two square waves in quadrature with channel A leading B for clockwise shaft rotation, as viewed from the encoder mounting face.
See *Waveform Diagrams*.

Output Types.....Open Collector – 20 mA max per channel
Push-Pull – 20 mA max per channel
Pull-Up – Open Collector with 2.2K ohm internal resistor, 20 mA max per channel
Line Driver – 20 mA max per channel (Meets RS 422 at 5 VDC supply.)

Index.....Once per revolution.
1 to 189 CPR: Ungated
190 to 10,000 CPR: Gated to output A
See *Waveform Diagrams*.

Max. FrequencyStandard Frequency Response is
200 kHz for CPR 1 to 2540
500 kHz for CPR 2541 to 5000
1 MHz for CPR 5001 to 10,000
Extended Frequency Response (optional) is
300 kHz for CPR 2000, 2048, 2500, and 2540.

Electrical Protection ..Reverse voltage and output short circuit protected. NOTE: Sustained reverse voltage may result in permanent damage.

Noise Immunity.....Tested to BS EN61000-6-2;
BS EN50081-2; BS EN61000-4-2;
BS EN61000-4-3; BS EN61000-4-6; BS EN500811

Quadrature.....67.5° electrical or better is typical,
Edge Separation 54° electrical minimum at temperatures > 99° C

Waveform Symmetry..180° ($\pm 18^\circ$) electrical (single channel encoder)

Accuracy.....Within 0.017° mechanical or 1 arc-minute from true position (for CPR >189).

Commutation.....Up to 12 pole. Contact Customer Service for availability.

Comm. Accuracy.....1° mechanical

Mechanical

Max Shaft Speed.....8000 RPM. Higher speeds may be achievable, contact Customer Service.

Shaft MaterialStainless Steel

Radial Shaft Load5 lb max. Rated load of 2 to 3 lb for bearing life of 1.2×10^{10} revolutions

Axial Shaft Load5 lb max. Rated load of 2 to 3 lb for bearing life of 1.2×10^{10} revolutions

Starting TorqueIP50- 0.05 oz-in
IP64- 0.4 oz-in

Moment of Inertia ...6.7 x 10^{-5} oz-in-sec² (4.8 gm-cm²)

Weight.....3 oz typical

Environmental

Storage Temp-25° to 85° C

Humidity.....98% RH non-condensing

Vibration.....10 g @ 58 to 500 Hz

Shock.....80 g @ 11 ms duration

Sealing.....IP50 standard; IP64 available

MODEL 15S STANDARD SERVO MOUNT M1

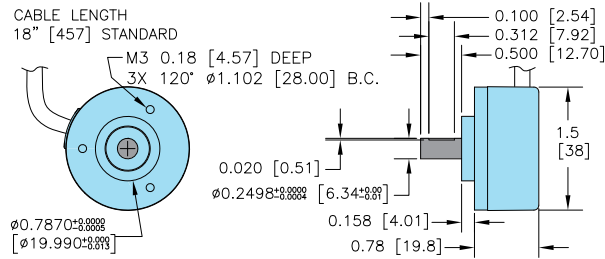

MODEL 15S SERVO MOUNT M2 & M9*

*M9 mount includes a 0.750" boss

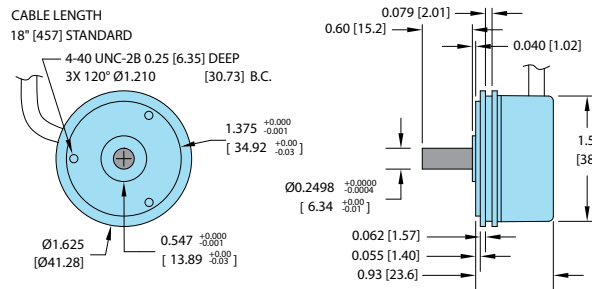

MODEL 15S SERVO MOUNT M5

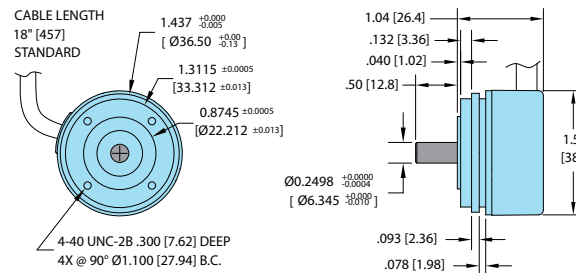

MODEL 15S SERVO MOUNT M6

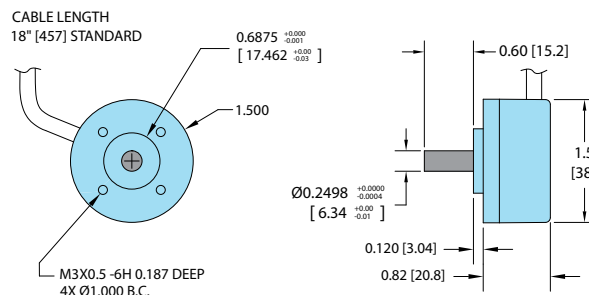

All dimensions are in inches with a tolerance of ± 0.005 " or ± 0.01 " unless otherwise specified. Metric dimensions are given in brackets [mm].

MODEL 15S SERVO MOUNT M7

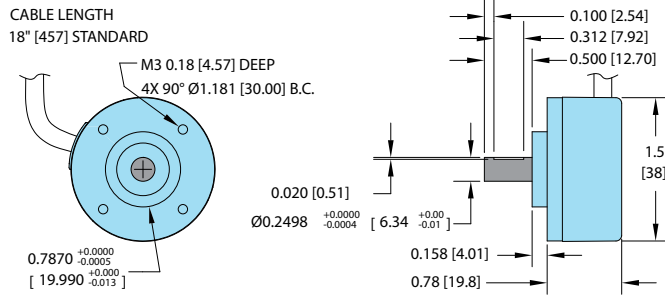

MODEL 15S SERVO MOUNT M4

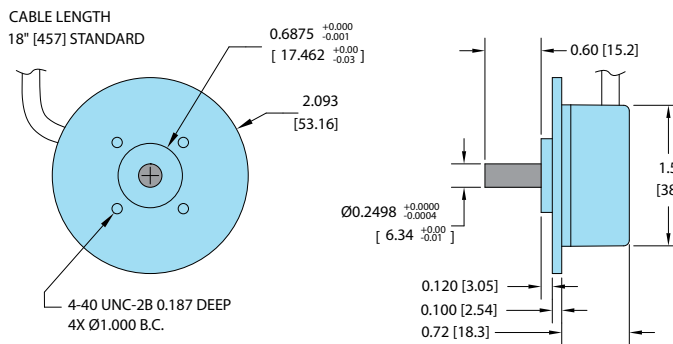

MODEL 15S SQUARE FLANGE M3

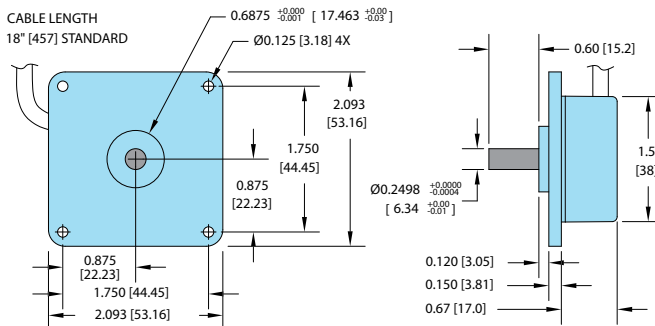

MODEL 15S SERVO MOUNT M8

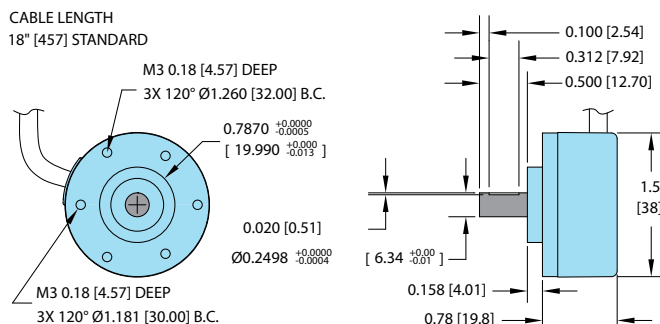

All dimensions are in inches with a tolerance of $\pm 0.005"$ or $\pm 0.01"$ unless otherwise specified.
Metric dimensions are given in brackets [mm].

WAVEFORM DIAGRAMS

Incremental Signals

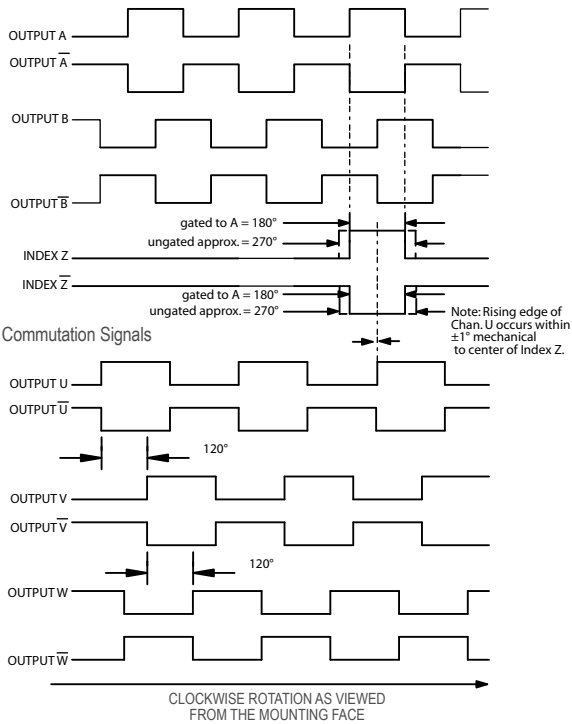

NOTE: ALL DEGREE REFERENCES ARE ELECTRICAL DEGREES.
WAVEFORM SHOWN WITH OPTIONAL COMPLEMENTARY SIGNALS A', B', Z' FOR HV AND OD OUTPUTS ONLY.

15-PIN HEADER

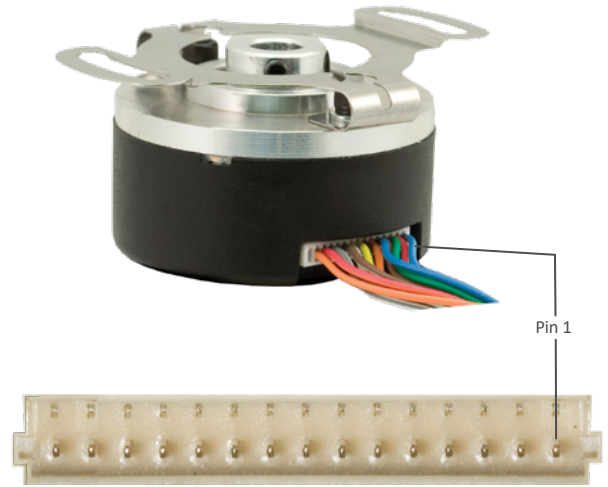

WIRING TABLE

For EPC-supplied mating cables, refer to wiring table provided with cable.
Trim back and insulate unused wires.

Function	Gland Cable† Wire Color	5-pin M12**	8-pin M12**	15-pin Header
Com	Black	3	7	1
+VDC	White	1	2	2
A	Brown	4	1	4
A'	Yellow	--	3	3
B	Red	2	4	6
B'	Green	--	5	5
Z	Orange	5	6	7
Z'	Blue	--	8	8
U	Violet	--	--	10
U'	Gray	--	--	9
V	Pink	--	--	14
V'	Tan	--	--	13
W	Red/Green	--	--	12
W'	Red/Yellow	--	--	11
Shield	Bare*	--	--	--

*CE Option: Cable shield (bare wire) is connected to internal case.

†Standard cable for non-commutated models is 24 AWG; for commutated units, conductors are 28 AWG.

**CE Option: Use cable cordset with shield connected to M12 connector coupling nut.