

FEATURES

- Compact Mounting
- High Performance
- Single Phase Input
- Reliable
- Led Indicators

RS PRO DIN Rail Power Supply - 230V ac Input Voltage, 24V dc Output Voltage, 10A Output Current, 240W

RS Stock No.: 136-8321



RS Professionally Approved Products bring to you professional quality parts across all product categories. Our product range has been tested by engineers and provides a comparable quality to the leading brands without paying a premium price.

Product Description

From RS Pro a range of high-performance power supplies in a compact 35mm DIN rail mounting package for convenience and space saving. These DIN rail mount power supplies are available with a range of power ratings from 15W to 240W and accept single-phase AC input for conversion into a single DC output of either 12V, 15V, 24V or 48V DC.

General Specifications

Type	Switch Mode
AC or DC Input Voltage	230VAC
AC or DC Output Voltage	24VDC
Number of Outputs	1
Special Features	Compact Size, Cooling by Free Air Convection, LED Indicator for DC Low, LED Indicator for DC Power On, 3-Years Warranty, 100% Full Load Burn-In Test
Mounting Type	DIN Rail, Vertical Mount
Short Circuit Protection	Yes
Over Voltage Protection	Yes
Indication of Output Voltage	LED, continuous green light
Applications	Sensors, Transmitters/receivers, Analyzers, PLCs Motors, Actuators, Solenoids, Relays

Electrical Specifications

RS Stock#	Input Voltage	Output Voltage	Output Current	Output Wattage	Efficiency (Typ)
136-8321	100VAC-240 VAC	24VDC	10A	240w	90%
136-8322	100VAC-240 VAC	48VDC	5A	240W	91%

Input Specifications		
Input Electrical Phase	Single	
Input current	1.3A	
Line Frequency	47Hz to 63Hz	
Inrush current at 25°C 230V	65A	
Efficiency (Typ.)	90%	
Power Factor (Cos phi)	0.96	
Output Specifications		
Output Voltage Adjustment	22V – 28V	
Hold Up Time	20ms/115VAC	
Line Regulation	2%	
Load Regulation	3%	
Voltage Isolation	Input-Output	3KVAC
	Input-Ground	1.5KVAC
	Output-Ground	1,5KVAC
Surge Voltage	2kV	
MTBF	230khrs	

Mechanical Specifications

Height	130mm
Depth	125mm
Width	60mm
Weight	1000g
Dimensions	60mm x 130mm x 125mm

Operation Environment Specifications

Operating Humidity	20% to 95% RH
Operating Temperature Range	-20 to 75°C
Storage Temperature Range	-40 to 85°C
Cooling	Natural convection

Approvals

Standards Met	CB, CE
---------------	--------



Stock Number	Nominal Input Voltage	Output Voltage	Output Current	Ripple (Max.)	Efficiency (Typ.)
136-8321	100-240VAC	24V	10A	1%Vo mVp-p	90%
136-8322	100-240VAC	48V	5A	1%Vo mVp-p	91%

Mechanical

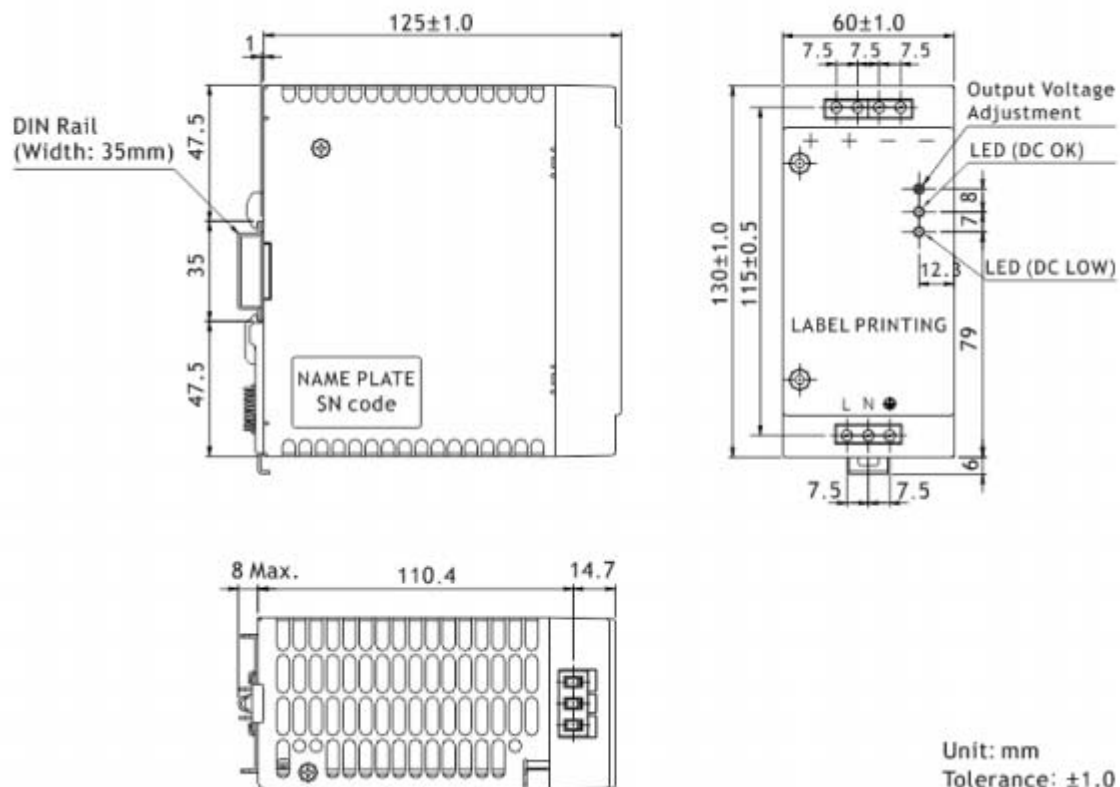



Marking	No.	Assignment
+	1	DC(+) Output Terminal
+	2	
-	3	DC(-) Output Terminal
-	4	
L	5	AC(L) Input Terminal
N	6	AC(N) Input Terminal
⏏	7	AC Grounding Terminal
V-ADJ.	/	DC Output voltage adjustment trimmer
DC OK	/	DC Output OK indication LED(Green)
DC LOW	/	DC Output Low indication LED(Red)

Electrical Curve

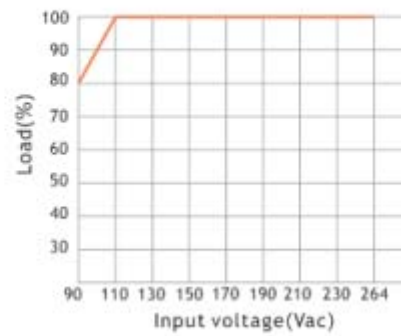
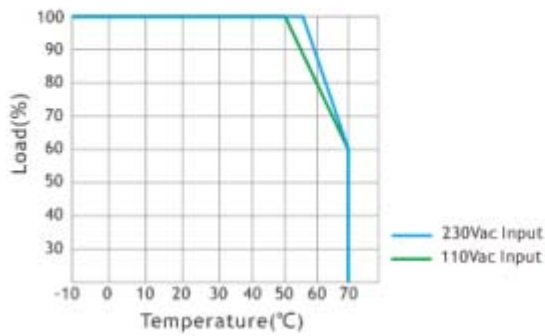

Block Diagram

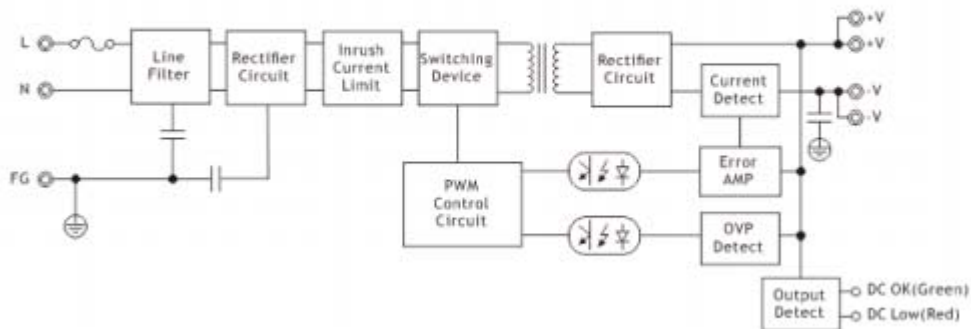

Series Operation

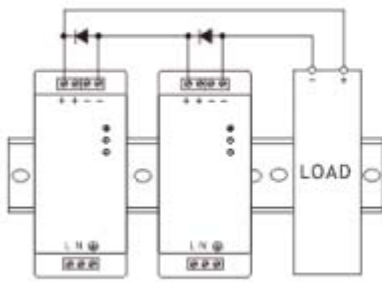

Series Operation A

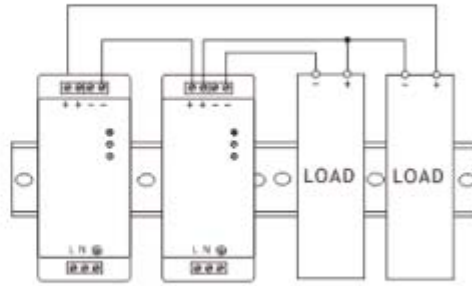

Series Operation B

Parallel Operation

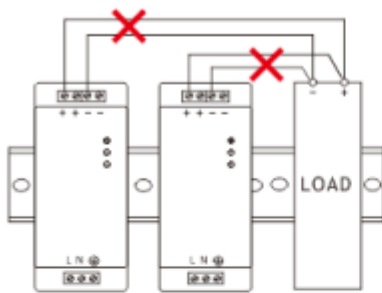

Parallel Operation A
(Unable to use)

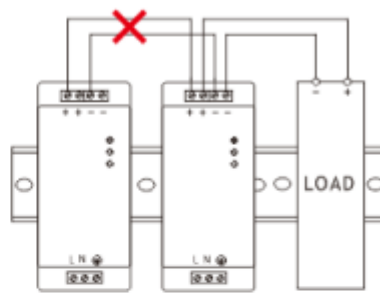

Parallel Operation B
(Unable to use)

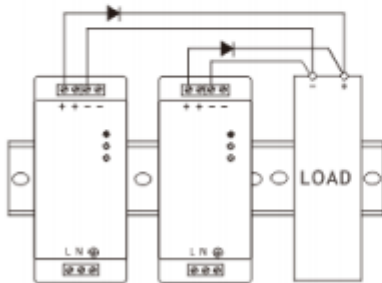

Parallel Operation C
(Backup)

Mounting Method

