

High-Coded Non-Contact Safety Door Switch D41D

Reduce the possibilities for defeat, simplify machine design and reduce installation efforts with quick and easy automatic pairing for one or more door switches at a time.



* The actuator is sold separately.

- Eliminate safety door switch bypass options
- Automatic pairing for easy installation
- Save space by installing door switch in narrow spaces and corners inside machinery
- Simplify your design by choosing the best option to fit your machine
- Complies with ISO 14119 (Type 4/High Coded), ISO 13849-1 (PLe)

For the most recent information on models that have been certified for safety standards, refer to your OMRON website.

 Refer to *Safety Precautions* on page 17

Three types of actuators fit in narrow spaces and corners inside machines



D41D-A1
Installation example: swinging door
• Fits in narrow spaces and corners



D41D-A2
Installation example: acrylic glass door
• Flat design matches the surroundings



D41D-A3
Installation example: sliding door, narrow space
• Compact size for acrylic glass doors

For actuator coding purposes, EN ISO 14119 also introduces a coding level classification that is applicable independently of the technology used. A high-coded safety switch is defined as one where a sensor is paired with a high-level coded actuator for which more than 1,000 variations are available.

D41D

Model Number Structure

Model Number Legend

Safety Door Switch Sensor

D41D - □ **C** **D** - □ □
(1) (2) (3) (4) (5) (6)

(1) Model

D: Non-Contact

(2) Coding level / Teaching limitation

1: High (Individual coding)

2: High (Individual coding, No limitation)

(3) Connection to controller

C: Cascade connection

(4) Diagnosis output

D: With diagnosis output

(5) Cable length

Blank: no cable

025: 25cm

(6) Connector

N1: M8

N2: M12

Actuator

D41D - **A** □
(1) (2)

(1) Model

D: Non-contact

(2) Actuator type

A1: Standard



A2: Flat

A3: Miniature

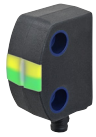

Ordering Information

List of Models

Sensors



Appearance	Coding level / Teaching limitation	Connection	Cable length	Model
	High (Individual coding)	Connector (M8)	---	D41D-1CD-N1
	High (Individual coding/No limitation)	Connecting cable 0.25-m long with Connector (M12)		D41D-2CD-025N2

Actuator (Sold separately)



Appearance	Name	Features	Model
	Standard	<ul style="list-style-type: none"> Mounting 2 x M4 Dimensions (W x D x H) 39 x 29.5 x 18 (mm) 	D41D-A1
	Flat	<ul style="list-style-type: none"> Mounting 2 x M5 (Countersunk screw) Dimensions (W x D x H) 60 x 16 x 6.8 (mm) 	D41D-A2
	Miniature	<ul style="list-style-type: none"> Mounting 1 x M3 (1.2 dia. hole, plus Twist protection) Dimensions (W x D x H) 22 x 9 x 7 (mm) 	D41D-A3

Accessory (Sold separately)

Connecting cables

Appearance	Name	Features	Cable length	Model
	Connecting cables with Connector M8	Connecting cables with Connector (M8) (female), 8-pole – 8 x 0.25mm ² , straight, IP67	2 m	D41D-8P5-CFM8-702M
			5 m	D41D-8P5-CFM8-705M
			10 m	D41D-8P5-CFM8-710M
	Connecting cables with Connector M12	Connecting cables with Connector (M12) (female), 8-pole – 8 x 0.25mm ² , straight, IP69	5 m	D41L-8P5-CFM12-905M
			10 m	D41L-8P5-CFM12-910M

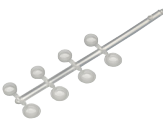
Sealing /Mounting

Appearance	Name	Purpose	Contents	Model
	Sealing Kit	Used to seal the mounting holes	4 flat plugs and 4 plugs with rim for high screw head	D41D-SK
	Mounting Set	Mounting plate: Used to fix to a non-flat surface such as a profile. Ferrule plug: Used for applications with considerable changes in ambient temperature.	2 mounting plates and 4 ferrule plugs	D41D-MS

D41D

Standards Certification

EU Declaration of Conformity

- Machinery Directive
- RE Directive
- RoHS Directive
- WEEE Directive



Dispose in accordance with applicable regulations.

Standards

- EN ISO 13849-1: 2015 PL e Category 4
- EN 60947-5-3
- EN 300 330
- EN ISO 14119
- IEC 61508
- EN 62061

UL Certification

- UL508
- CAN/CSA C22.2 No.14

Regions where D41D can be used

The product can be used in Japan, the United States of America, Canada, EU member states, the United Kingdom, and People's Republic of China. The use in other countries may conflict with radio laws of the countries.

Ratings and Specifications

Model		D41D
Technical		
Detection method	RFID	
Frequency band	125 kHz	
Transmitter outputs	-6 dBm max.	
Interlock type (ISO 14119)	Type 4	
Coded level (ISO 14119)	D41D-1: High (individual coding) D41D-2: High (individual coding, No limitation)	
Actuator	D41D-A1, D41D-A2, D41D-A3	
Response time (ON to OFF)	100 ms max.	
Risk time	200 ms max.	
Startup time	2 s max.	
Typical operating distance (Sn) (IEC 60947-5-3)	12 mm (lateral actuation: 9 mm)	
Assured operating distance (Sao) (IEC 60947-5-3)	10 mm (-10 to 60°C) 6 mm (-10 to 60°C, lateral) 8 mm (-25 to 65°C) 4 mm (-25 to 65°C, lateral)	
Assured switch-off distance (Sar)	18 mm (lateral actuation: 15 mm)	
Differential travel	<2.0 mm	
Repeat accuracy (R)	<0.5 mm	
Electrical		
Supply voltage (Ue)	24 VDC (-15%/+10%) (stabilized PELV-power supply)	
Current consumption (Io)	35 mA	
Overvoltage category	III	
Pollution degree	3 (UL certification is 2)	
Conditional short-circuit current	100 A	
External device fuse rating	2 A max.	
Safety input	Accepted test pulse duration on input signal	1.0 ms max.
	Test pulse interval	100 ms min.
	Current consumption per input	5 mA
Safety output (OSSD)	Switching element	PNP type, short-circuit proof
	Utilization category	DC-12: 24 VDC (Ue)/0.25 A (Ie) DC-13: 24 VDC (Ue)/0.25 A (Ie)
	Operating current (Ie1)	0.25 A max.
	Voltage drop (Ud)	<1 V
	Test pulse duration	1.0 ms max.
	Test pulse interval	1,000 ms
Auxiliary output	Switching element	PNP type, short-circuit proof
	Utilization category	DC-12:24 VDC (Ue)/0.05 A (Ie) DC-13:24 VDC (Ue) /0.05 A (Ie)
	Operating current (Ie2)	0.05 A max.
	Voltage drop (Ud)	<2 V
Switching frequency (f)	1 Hz	
Rated insulation voltage (Ui)	32 VDC	
Rated impulse withstand voltage (Uimp)	0.8 kV	
Minimum operating current (Im)	0.5 mA	
OFF-state leakage current (Ir)	<0.5 mA	
Mechanical		
Fixing screws	4 × M4 (Refer to the outline drawing for the actuator)	
Tightening torque of fixing screws	0.8 N·m (Refer to the outline drawing for the actuator)	
Material	Thermoplastic PBT (enclosure)	
Weight	Unit: <50 g, Package: <110 g	

D41D

Model	D41D
Environmental	
Ambient operating temperature	-25 to 65°C
Ambient storage temperature (including during transportation)	-25 to 85°C
Ambient operating humidity	93% max. (non-condensing, non-icing)
Degree of protection (IEC 60529)	IP65 and IP67
Vibration resistance	10 to 55 Hz, amplitude 1.0 mm
Shock resistance	30 g/11 ms
Connection	
Series connection	31 max. *1
Cable lengths	100m max. (between switch and power supply)
Connection	D41D-1CD-N1: Connector plug M8, 8-pole, A-coded D41D-2CD-025-N2: Connecting cable 0.25-m long with connector M12

*1. Refer to *Connection* on page 10 for connection specifications with the Safety controller.

Safety classification information

Standard	ISO 13849-1, IEC 61508, IEC 62061
PL	e
DC	99%
Safety Category	4
PFH (number)	$6.8 \times 10^{-10}/h$
PFD	1.2×10^{-4}
SIL	Suitable for SIL3 applications
Mission time	20 years

Note: 1. If multiple safety switchgears are involved in the same safety function, the PFH values of the individual components must be added.

UL

For use in NFPA 79 Applications.

Adapters providing field wiring means are available from the manufacturer.

Refer to manufacturer's information.

For use in Pollution Degree 2 Environment.

FCC

This device complies with part 15 of the FCC Rules and Industry Canada license-exempt RSS standard(s).

Operation is subject to the following two conditions:

1. This device may not cause harmful interference, and
2. this device must accept any interference received, including interference that may cause undesired operation.

This device complies with the Nerve Stimulation Exposure Limits (ISED RSS-102) for direct touch operations. Changes or modifications not expressly approved by OMRON Corporation could void the user's authority to operate the equipment.

Engineering Data (Typical Data)

Detection Range

Operating distance

The side allows for a maximum height misalignment (X) of sensor and actuator of ± 8 mm (e.g. mounting tolerance or due to guard door sagging). The axial misalignment (Y) is max. ± 18 mm.

Actuating curves

The actuating curves represent the typical operating distance of the safety sensor during the approach of the actuator subject to the actuating direction.

Transverse misalignment

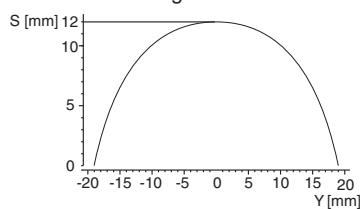

Height misalignment

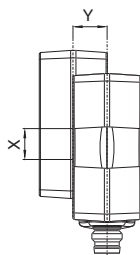
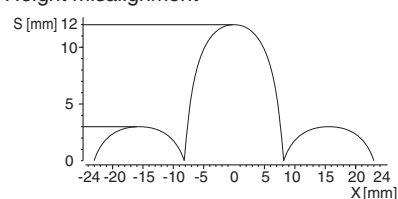

The continuous signal of the yellow LED signals the actuator detection;
the flashing of the yellow LED signals that the safety door switch is actuated in the different travel area.

Preferred actuation directions: from front or from side

In case of a lateral actuation, the operating distances are reduced by approx. 3 mm.

Recommended Adjustment

Align the safety door switch and actuator at a distance of 0.5 x assured operating distance (Sao).

The correct functionality of both safety channels must be checked by means of the connected safety controller.

D41D

Actuator Mounting Direction

(Unit: mm)

D41D-A1

Actuation from front

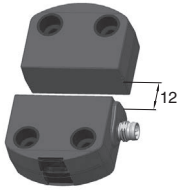

Actuation from side

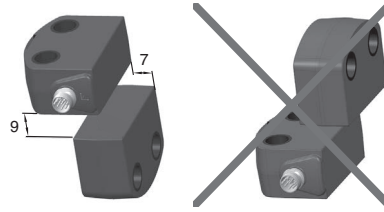

Lateral actuation only from the shown sensor side.

D41D-A2

Actuation from front

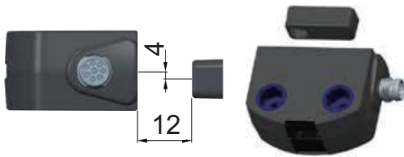

Actuation from side

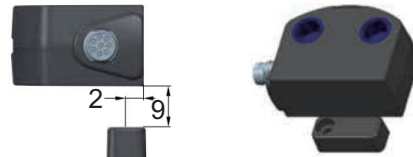

Lateral actuation only from the shown sensor side.

D41D-A3

Actuation from front

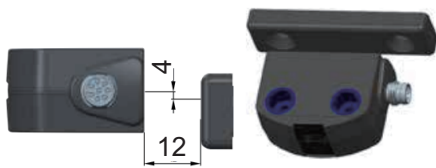

Actuation from side

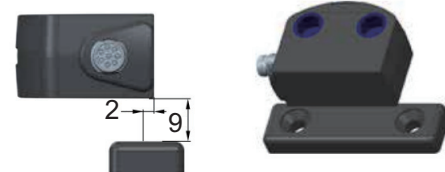

Lateral actuation only from the shown sensor side.

Connection

Pin assignment

Function		Pin assignment of connector plug M8/M12, 8-pole, A-coded	Color code of the OMRON's connector (M8/M12 connector cable) M8: D41D-8P5-CFM8-7□□M M12: D41L-8P5-CFM12-9□□M
A1	U _e	1	WHITE
X1	Safety input 1	2	BROWN
A2	GND	3	GREEN
Y1	Safety output 1	4	YELLOW
OUT	Auxiliary output	5	GRAY
X2	Safety input 2	6	PINK
Y2	Safety output 2	7	BLUE
IN	without function	8	RED

Note: 1. When using an OMRON cable, the tightening torque of the connector is 1 N•m

Wiring Examples

The application examples shown are suggestions. They however do not exempt the user from carefully checking whether the Safety door switch and its set-up are suitable for the individual application.

The power supply for the safety door switch must provide protection against permanent overvoltage.

To that effect, stabilized PELV supply units must be used. The safety outputs can be directly connected in the safety circuit of the control system. For applications of PL e / safety category 4 in accordance with ISO 13849-1, the safety outputs of the safety door switch or safety door switch of the chain must be connected to a safety controller or safety relay unit of the same Safety Category. If the safety door switch is wired to relays or to non-safety relevant control components, a new risk analysis must be carried out.

If the safety door switch is connected to the safety input of a safety controller, the controller must have a dual-channel monitoring time of at least 100 ms and the accepted test pulse duration of at least 1 ms. Also, the cross-wire-short monitoring function must be disabled. Typically, a switch-off time of 250 μs is reached with a 30-m connecting cable. The switch-off time of the safety door switch is additionally extended depending on the cable length and the capacity of the cable used.

D41D series connection example



When connecting multiple safety door switches in series, apply 24 VDC to safety inputs X1 and X2 on the Nth unit, as shown in the figure below. Connect safety outputs Y1 and Y2 to safety inputs X1 and X2 of the following safety door switch.

Connect safety outputs Y1 and Y2 of the first unit to the safety controller or safety relay unit.

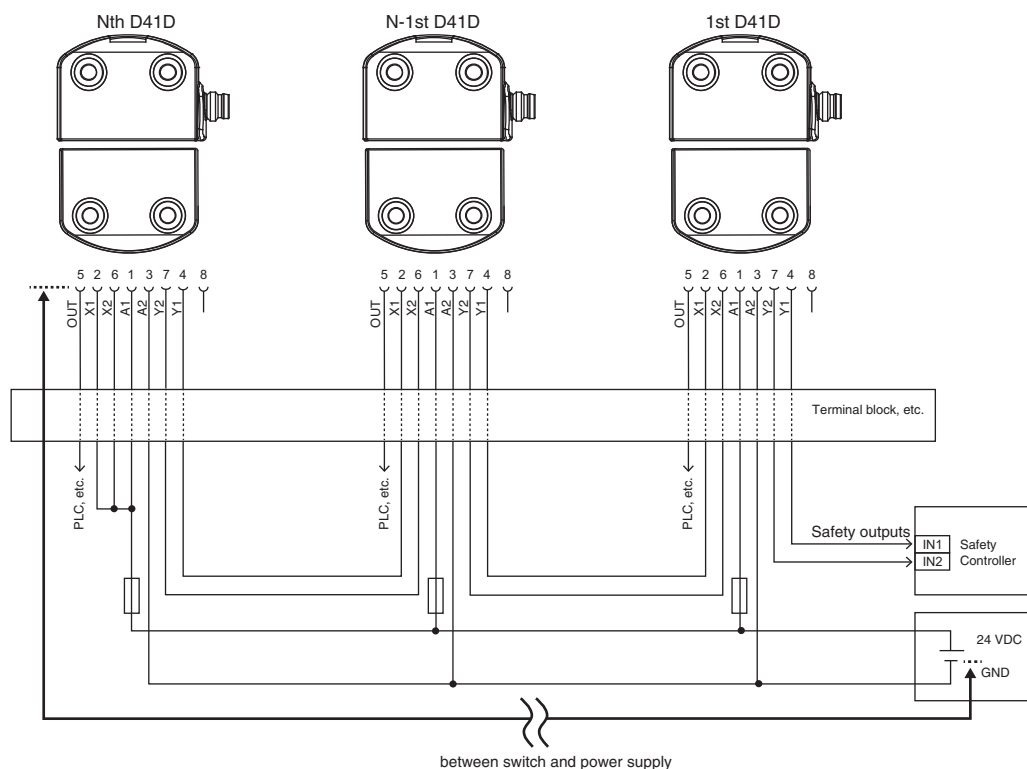



When connecting a single safety door switch to the safety controller or safety relay unit, apply 24 VDC to safety inputs X1 and X2 in the same manner as the Nth unit shown below, and then connect safety outputs Y1 and Y2 to the safety controller or safety relay unit.

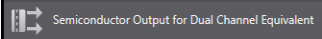
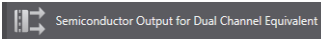
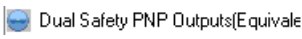
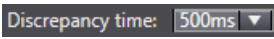
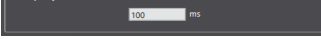
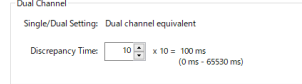
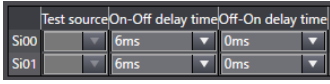
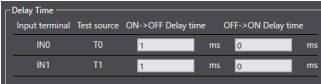

Safety controller settings

OMRON's safety controller		NX-SL and NX-SI 	GI-SMD/SID 	G9SP 
Input device setting	Input device	Semiconductor Output for Dual Channel Equivalent 	Semiconductor Output for Dual Channel Equivalent 	Dual Safety Semiconductor Output (Equivalent) 
	Discrepancy time	Set discrepancy time to 100 ms or more NX-Series Safety Control Unit User's Manual Refer to the Dual Channel Evaluation in No.Z930. 	Set discrepancy time to 100 ms or more GI-S series Safety I/O Terminal User's Manual Refer to the Dual Channel Evaluation in No.Z400. Example 	Set discrepancy time to 0 (disabled) or 100 ms or more G9SP series Safety Controller User's Manual Refer to the Dual Channel Evaluation in No.Z922. Example 
	Filtering out test pulses	Set input filter ON->OFF delay time to 1 ms or more NX-Series Safety Control Unit User's Manual Refer to the Input Filters in No.Z930. Example 	Set input filter ON->OFF delay time to 1 ms or more GI-S series Safety I/O Terminal User's Manual Refer to the Input Filter Function in No.Z400. Example 	Set input filter OFF delay time to 1 ms or more G9SP series Safety Controller User's Manual Refer to the Input Filters in No.Z922. Example Off On Delay: <input type="text" value="0"/> x 4 = 0 ms (0 ms - 1000 ms) On Off Delay: <input type="text" value="1"/> x 4 = 4 ms (0 ms - 1000 ms)

Combination with a safety relay unit

OMRON's safety relay unit		G9SA 	G9SE 	G9SB 	G9SX 
Input device Safety-door switch	D41D	Connectable	Not connectable	Connectable	Connectable *1

*1. The G9SX-NS□ cannot be connected to D41D.

*2. Refer to the instruction manual or user's manual of each product for how to extend the wiring.

Teaching

Individually coded safety door switches and actuators will require the following teach-in procedure:

1. Keep the actuator away from the detection range and switch the safety door switch's voltage supply off and back on.
2. Introduce the actuator in the detection range. The teach-in procedure is signalled at the safety door switch, red LED on, yellow LED flashes (1 Hz).
3. After 10 seconds, the yellow LED gives brief cyclic flashes (3 Hz). Switch off the supply voltage of the safety door switch. (If the voltage is not switched off within 5 minutes, the safety door switch cancels the teach-in procedure and signals a false actuator by 5 red flashes).
4. Switch the supply voltage back on. The actuator must be detected once more in order to activate the taught actuator code. In this way, the activated code is definitively saved.

For ordering suffix D41D-1, the executed allocation of safety door switch and actuator is irreversible.

When the above procedure is attempted with a D41D-1 which already completed teaching, the teaching procedure will not start.

For ordering suffix D41D-2, the teach-in procedure for a new actuator can be repeated an unlimited number of times. When a new actuator is taught, the code, which was applicable until that moment, becomes invalid. Subsequent to that, the safety outputs will be disabled for ten minutes, thus providing for an increased protection against intentional tampering.

The green LED will flash until the expiration of the time (10 minutes) of the enabling inhibit and the detection of the new actuator.

In case of power failure during the lapse of time, the 10-minutes tampering protection time will restart.

When the above procedure is attempted with a combination of D41D-2 and actuator which already completed teaching, the teaching procedure will not start.

Operating Principle

Operating Principle

The safety outputs can be connected to the safety circuit of the control system. The opening of a guard door, i.e. the actuator is removed out of the active zone of the safety door switch, will immediately disable the safety outputs of the safety door switch. (For operating distances, refer to *Ratings and Specifications* on page 5.)

Any error that does not immediately affect the functionality of the safety door switch (e.g. too high ambient temperature, interference potential at the safety outputs, cross-wire short) will lead to a warning message, disabling of the auxiliary output and a delayed shutdown of the safety outputs. (Refer to *Troubleshooting* on page 16.)

The safety outputs are disabled if the error warning is active for 30 minutes. The signal combination, auxiliary output disabled and safety channels still enabled, can be used to stop the production process in a controlled manner.

After fault rectification, the error message is reset by opening and reclosing the corresponding guard door. The safety outputs enable and allow a restart.

Diagnostic Functions

Operating principle of the diagnostic LEDs

The safety door switch indicates the operating condition and faults by means of three-color LEDs located in the lateral surfaces of the safety door switch.

The green LED indicates that the safety door switch is ready for operation. The supply voltage is on and all safety inputs are present. Flashing (1 Hz) of the green LED signals that a voltage is missing on one or both of the safety inputs (X1 and/or X2).

The yellow LED always signals the presence of an actuator within range.

If the actuator is operating near the limit of the differential travel range of the safety door switch, the LED is flashing.

The flashing can be used to prematurely detect variations in the clearance between the safety door switch and the actuator (e.g. sagging of a guard door). The safety door switch must be adjusted before the distance to the actuator increases and before the safety outputs are disabled, thus stopping the machine. If an error is detected, the red LED will be activated.

Operating principle of the auxiliary output

An auxiliary output additionally indicates the operating condition (refer to Table 1). The auxiliary output OUT can be used for central visualization or control functions, e.g. in a PLC. It indicates the switching condition as shown in Table 1.

Dimensions

Sensors

D41D-1CD-N1

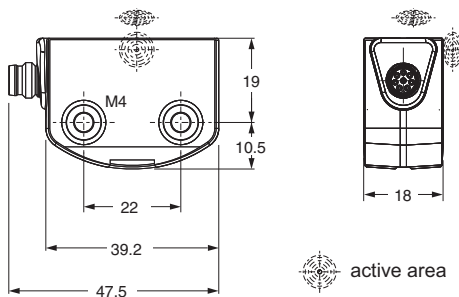
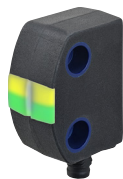

D41D-2CD-025N2

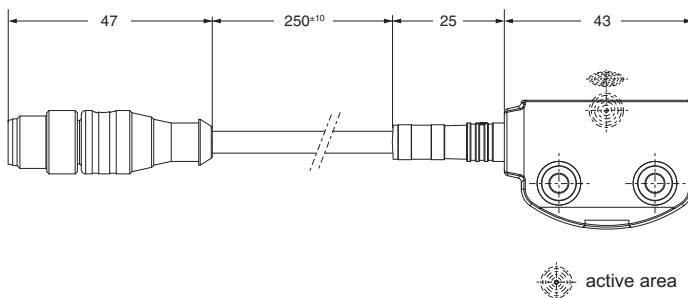

D41D

Actuator (Sold separately)

D41D-A1

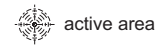
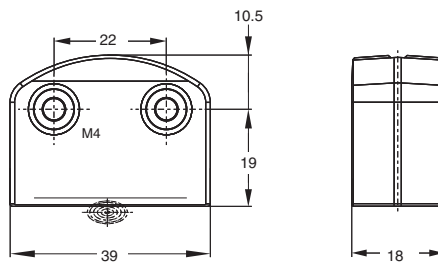

M4 screw
(Tightening torque: 0.8 N•m)

D41D-A2

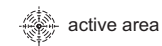
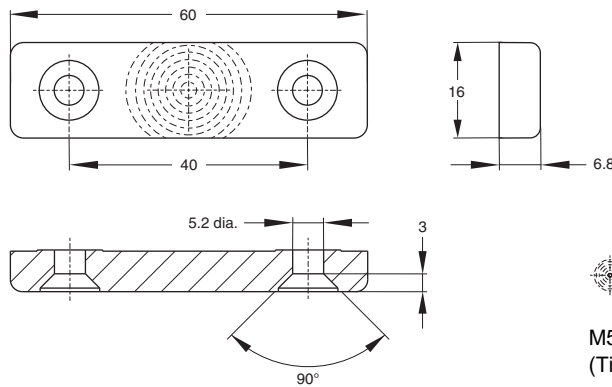

M5 countersunk screw
(Tightening torque: 2 N•m)

D41D-A3

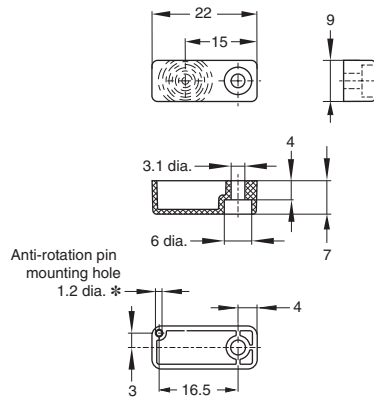

* D41D-A3 mounting hole is fixed in place with an M3 screw. The actuator can be prevented from twisting caused by screw tightening torque during installation by passing a pin up to 1.1 mm in size through the hole in the rear section of the D41D-A3.

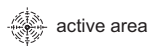

M3 screw
(Tightening torque: 0.6 N•m)
1.2 dia. hole, plus Twist protection

Accessory (Sold separately)

Sealing kit

D41D-SK

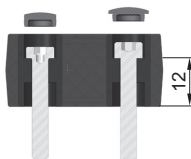

Mounting

The mounting holes provide for a mounting by means of M4 screws (max. tightening torque 0.8 N•m).

The product can be mounted in any position. The minimum bend radius of the -025-type cable is 25 mm.

The active areas of the safety door switch and the actuator have to face each other.

The safety door switch must only be used within the assured operating distances $\leq S_{ao}$ and $\geq S_{ar}$.

To avoid any interference inherent to this kind of system and any reduction of the operating distances, please observe the following guidelines:

- See the figures below for the minimum distances between two safety door switches and other systems of the same frequency (125 kHz).

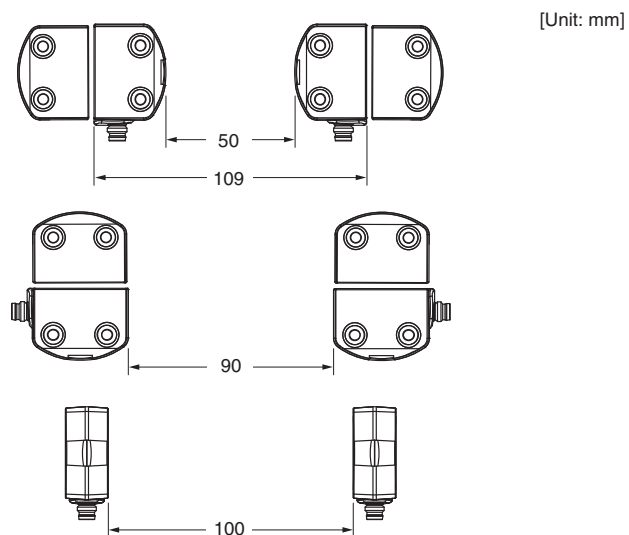

Troubleshooting

Error

Errors that, which no longer guarantee the function of the safety door switch (internal errors) cause the safety outputs to be disabled within the risk time.

After the rectification of the error, the error message is reset by opening the corresponding guard door.

Error warning

The auxiliary output can also be used to detect clearance variations between the safety door switch and the actuator in the same way as the yellow LED.

An active fault is visualized by the red LED and causes the auxiliary output to be disabled. The safety outputs are disabled after a maximum of 30 minutes if the fault is not rectified. This signal combination, auxiliary output disabled and safety channels still enabled, can be used to stop the production process in a controlled manner.







LED indication (red)		Error cause
1 flash pulse		Error output Y1
2 flash pulses		Error output Y2
3 flash pulses		Cross-wire short between Y1 and Y2
4 flash pulses		Ambient temperature too high
5 flash pulses		Incorrect or defective actuator
Continuous red		Internal fault, with yellow flashing teaching procedure

Table 1: Diagnostic information for safety door switch with auxiliary output

Status of switch	LEDs			Auxiliary output	Safety outputs Y1, Y2	Note
	Green	Red	Yellow			
Supply voltage	On	Off	Off	0 V	0 V	Voltage on
Actuated	On	Off	On	24 V	24 V	The yellow LED always signals the presence of an actuator within range.
Actuated in limit area	On	Off	Flashes (1Hz)	24 V pulsed	24 V	The safety door switch must be adjusted before the distance to the actuator increases and before the safety outputs are disabled, thus stopping the machine.
Error warning, switch actuated	Off	Flashes	On	0 V	24 V	When the error warning is not rectified within 30 minutes, the safety outputs are disabled.
Error	Off	Flashes	On	0 V	0 V	Refer to table with flash codes
Teach actuator	Off	On	Flashes	0 V	0 V	Safety door switch in teaching mode
Tampering protection time *1	Flashes	Off	Off	0 V	0 V	10 minutes pause after re-teaching
Error in input circuit X1 and/or X2	Flashes (1Hz)	Off	Off	0 V	0 V	When door is open
Error in input circuit X1 and/or X2	Flashes (1Hz)	Off	On	24 V	0 V	When door is closed

*1. Refer to Teaching.

Safety Precautions



Be sure to read the precautions for all models in the website at: <http://www.ia.omron.com/>.

Indication and Meaning for Safe Use

Warning Indications

 WARNING	Indicates a potentially hazardous situation which, if not avoided, will result in minor or moderate injury, or may result in serious injury or death. Additionally there may be significant property damage.
Precautions for Safe Use	Supplementary comments on what to do or avoid doing, to use the product safely.
Precautions for Correct Use	Supplementary comments on what to do or avoid doing, to prevent failure to operate, or undesirable effect on product performance.

Meaning of Product Safety Symbols

	General prohibition Instructions on unspecified prohibited action.
	General instructions Instructions on unspecified general action.

WARNING

Use only appropriate components or devices complying with relevant safety standards corresponding to the required performance level and safety category. Failure to do so may result in serious injury or death. Conformity to requirements of the performance level and safety category must be determined as an entire system. It is recommended to consult a certification body regarding assessment of conformity to the required safety level.



Do not apply DC voltages exceeding the rated voltages, nor any AC voltages to the product. Failure to do so may result in serious injury or death.



Install the switch and actuator in a position where the opening of the guard door can be detected within a safe distance. Failure to do so may result in serious injury or death.



When complying with safety standards, install the product in an appropriate manner in accordance with ISO 14119, with due consideration of the risk of defeat by the operator. Failure to do so may result in serious injury or death.



Make sure that the DC power supply meets the following items. Failure to do so may result in serious injury or death.

- Satisfies the requirements of PELV power supply defined in IEC 60204-1.
- Satisfies the requirements of class 2 circuits defined in UL508.



Precautions for Safe Use

1. Disconnect the product from power supply when wiring the product. Failure to do so may cause unexpected operation of devices connected to the product.
2. Wire the input and output terminals correctly and verify the correct operation of the product before using the system in which the product is incorporated. Incorrect wiring may lead to loss of the safety function.
3. Do not use the product in any direction other than the specified mounting orientations of the main body and actuator.
4. Dispose of the product in accordance with the laws set by each country.

Precautions for Correct Use

1. Do not drop the product to the ground or expose to excessive vibration or mechanical shocks. Doing so may damage the product and cause failure.
2. Do not store or use the product under the following conditions. Doing so may damage the product and cause failure.
 - 1) At ambient operating temperatures out of the range of -25 to 65°C
 - 2) At ambient storage temperatures out of the range of -25 to 85°C
 - 3) At relative humidity of 93% or more
 - 4) In direct sunlight
 - 5) Under drastic temperature changes
 - 6) In high humidity that causes condensation
3. Keep the product away from oil or solvent. Oil or solvent make the marking on the product illegible and cause deterioration of some parts.
4. Do not use in an environment with corrosive gas.
5. The product may not operate normally in the vicinity of devices that generate strong radio waves or magnetic fields, such as RFID systems, proximity sensors, motors, inverters, and switch-mode power supplies. If the device is used in the vicinity of such devices, check the effect before use.
6. Installing the switch and the actuator on a metallic material may affect the operating distance. If installation on a metallic material is necessary, be sure to check the effect on the operating distance before use.
7. Tighten the screws with a specified torque.
8. Use the wires specified by OMRON to wire the product. (Refer to *Connection* on page 9.)
9. Do not extend the cables in excess of the specification of this product. Carry out electrical connection according to the wiring examples shown in this document and verify the correct operation of the product.
10. During installation, make sure that the safety door switch does not come in contact with the actuator due to rattling of the guard door. (The performance of the product may be degraded by a collision caused by opening or closing the guard door.)
11. Do not pull or bend the cable excessively. A disconnection may cause a malfunction.
12. Risk time remains unchanged by series connection. However, carry out electrical connection according to the wiring examples shown in this document.
13. Be sure to inspect the product daily and every 6 months. Failure to do so may cause a system failure and serious injury.
14. When determining the safety distance, take into account the delay of the output of the product caused by the response time. Failure to do so may cause the operator to reach the hazardous source before the machine is stopped, resulting in serious injury.
15. Install the product so that the LED indicators of the safety door switch are as visible as possible. Misinterpreting the status of the safety door switch may result in danger.
16. Do not use the product at an altitude of 2,000 m or higher.
17. Do not connect a product different from this product in series with this product. Doing so may disturb waveforms of the input and output signals, leading to loss of the safety function.
18. Do not use the product in the water or continuous water exposure environment. Doing so may cause water to leak into the product. (The degree of protection does not guarantee the protection under continuous water exposure environment.)

- 19.** Do not tamper the product with a replacement actuator.
Store replacement actuators in a safe place where they cannot be easily reached.
- 20.** Build a safety system using the outputs of both Safety Outputs 1 and 2. Wiring with only one safety output may lead to loss of the safety function due to a single failure.
- 21.** Wiring should meet the requirements specified in Section 9.4.3 of IEC 60204-1 to prevent malfunction due to ground faults in the safety output lines.
- 22.** Do not wire the product to an input of a safety controller in parallel.
- 23.** Do not try to disassemble, repair, or modify the product. Doing so may cause loss of the safety function.
- 24.** Do not operate the product in an environment with flammable or explosive gas.
- 25.** After installation of the product, qualified personnel should verify to see that the installation, inspection, and maintenance are properly performed. The qualified personnel should be qualified and authorized to secure the safety on each phase of design, installation, running, maintenance and disposal of system.
- 26.** Auxiliary output is NOT a safety output. Do not use the Auxiliary output individually for any safety function. Such incorrect use causes loss of the safety function of the product and its relevant systems.
- 27.** Disconnect the product and the controller connected to the product from power supply when replacing the product. Failure to do so may cause unexpected operation of devices connected to the product.
- 28.** The safety function may not operate normally due to a malfunction of the wiring, setting, or switch, and the machine may continue to operate, which may result in personal injury. Make sure that the safety function works before starting operation.
- 29.** Do not use the product as a door stopper. (The performance of the product may be degraded due to a collision caused by opening and closing the guard door.)

Set-up and Maintenance/Disassembly and Disposal

Set-up and Maintenance

Functional testing

The safety function of the safety components must be tested.
The following conditions must be previously checked and met:

1. Fitting of the sensor and the actuator.
2. Fitting and integrity of the power cable.
3. The system is free of dirt and soiling (in particular metal chips).

Maintenance

Maintenance frequency
SIL3 / PLe at least once a month
SIL2 / PLd at least once a year

(Daily inspection)

- For each guard door, check that the machine stops when the guard door opens.

(Inspection every 6 months)

1. Check the fitting and integrity of the safety door switch, the actuator and the cable.
2. Remove possible metal chips.
3. Check that the cable is connected correctly and there is no problem.

Disassembly and Disposal

Disassembly

The product must be disassembled in a de-energized condition only.

Disposal

The product must be disposed of in an appropriate manner in accordance with the national prescriptions and legislations.

High-Coded Safety Door Switch

High-Coded Non-Contact Safety Door Switch
D41D

Matches with machine design. Initial setup by batch pairing is quick and easy.

- Tamper-proof safe/guard switch to prevent human error
- Easy automatic pairing
- Fits in narrow spaces and corners inside machines
- Three types of actuators
- Complies with IEC 61508 (SIL 1/PL 1) (See High-Coded), IEC 61508-3 (PL 1)

* This actuator is sold separately. For more information, refer to page 288 of the catalog.

Three types of actuators fit in narrow spaces and corners inside machines

D41D-A1 Installation: easy-to-use, easy to install
• Fits in narrow spaces and corners

D41D-A2 Installation: easy-to-use, easy to install
• Fits in narrow spaces and corners

D41D-A3 Installation: easy-to-use, easy to install
• Fits in narrow spaces and corners

A high-coded safety switch is defined as one where a sensor is paired with a high-level-coded actuator for which more than 100 combinations are available.

OMRON 1

High-Coded Non-Contact Safety Door Switch
D41D
(No.F112)

High-Coded Guard Lock Safety Door Switch
D41L

Keep your machines hygienic

- Tamper-proof safe/guard switch to prevent human error
- Hygienically designed switch
- Smooth surface, easy to clean
- Smooth surface prevents water and foreign matter from collecting
- Smooth surface prevents static accumulation
- Complies with IEC 61508 (SIL 1/PL 1) (See High-Coded), IEC 61508-3 (PL 1)
- CE/UL/ULC certified

* This actuator is sold separately. For more information, refer to page 288 of the catalog.

Identical mounting for left and right hinged doors

Features

- Easy-to-use, easy to install
- Tamper-proof safe/guard switch to prevent human error
- Hygienically designed switch
- Smooth surface, easy to clean
- Smooth surface prevents water and foreign matter from collecting
- Smooth surface prevents static accumulation
- Complies with IEC 61508 (SIL 1/PL 1) (See High-Coded), IEC 61508-3 (PL 1)
- CE/UL/ULC certified

A high-coded safety switch is defined as one where a sensor is paired with a high-level-coded actuator for which more than 100 combinations are available.

OMRON 1

High-Coded Guard Lock Safety Door Switch
D41L
(No.F113)

OMRON AUTOMATION AMERICAS HEADQUARTERS • Chicago, IL USA • 847.843.7900 • 800.556.6766 • automation.omron.com

OMRON CANADA, INC. • HEAD OFFICE
Toronto, ON, Canada • 416.286.6465 • 866.986.6766 • automation.omron.com

OMRON ELECTRONICS DE MEXICO • HEAD OFFICE
Ciudad de México • 52.55.5901.4300 • 01.800.386.6766 • mela@omron.com

OMRON ELECTRONICS DE MEXICO • SALES OFFICE
San Pedro Garza García, N.L. • 81.12.53.7392 • 01.800.386.6766 • mela@omron.com

OMRON ELECTRONICS DE MEXICO • SALES OFFICE
Eugenio Garza Sada, León, Gto • 01.800.386.6766 • mela@omron.com

OMRON ELETRÔNICA DO BRASIL LTDA • HEAD OFFICE
São Paulo, SP, Brasil • 55 11 5171-8920 • automation.omron.com

OMRON ARGENTINA • SALES OFFICE
Buenos Aires, Argentina • +54.11.4521.8630 • +54.11.4523.8483
mela@omron.com

OTHER OMRON LATIN AMERICA SALES
+54.11.4521.8630 • +54.11.4523.8483 • mela@omron.com