

## FEATURES

- 7.5mm width
- DIN Rail mounting
- Integrated dual voltage
- On delay timing function
- LED indications for power and relay status
- SPCO output relay
- 0.3s-30hrs timing range
- Wide supply voltage range
- IP20 (terminals), IP40 (enclosure) protection
- Offers a “one stop solution” for your power management system

## RS PRO SPDT Timer Relay - 0.3 s → 30 h, 1 Contacts, ON Delay, DIN Rail

RS Stock No.: 896-6816



RS Professionally Approved Products bring to you professional quality parts across all product categories. Our product range has been tested by engineers and provides a comparable quality to the leading brands without paying a premium price.

## Product Description

RS PRO On delay time delay relay is a dual voltage, single function timer that is compact in size and suitable for DIN Rail mounting.

## General Specifications

<b>Switch Configuration</b>	SPDT
<b>Mode of Operation</b>	ON Delay
<b>Contact Configuration</b>	CO
<b>Number of Timer Functions</b>	Single
<b>Number of Contacts</b>	1
<b>Time Range</b>	0.3s to 30h
<b>Time Increment</b>	Seconds
<b>Time Delay</b>	100ms
<b>Applications</b>	Production, Safety, On-delay timers, Off-delay timers, Interval-on-operate, Flasher, Repeat cycle

## Electrical Specifications

<b>Power Supply</b>	External
<b>Supply Voltage</b>	24V ac/dc, 110V ac
<b>Maximum Voltage</b>	24 V ac/dc, 110 V ac
<b>Current Maximum</b>	5A
<b>Current Minimum</b>	0.1A
<b>Relay Output</b>	SPCO
<b>Terminal Type</b>	Screw

## Mechanical Specifications

Mounting Type	DIN-Rail
Depth	58.5 mm
Width	90 mm
Length	17.5 mm

## Operation Environment Specifications

Maximum Operating Temperature	55°C
Minimum Operating Temperature	-10°C

## Protection Category

IP Rating	IP20; IP40
-----------	------------

## Approvals

Compliance/Certifications	CE, RoHS
---------------------------	----------







**ELECTRONIC TIME RELAYS**

**RS Stock No's:**  
**ON-Delay**  
**896-6810 & 896-6816**  
**Star-Delta Starter Timer**  
**896-6832, 896-6835 & 896-6838**  
**Signal OFF-Delay**  
**896-6822 & 896-6829**

**Terminal Details:**

	1.1 Nm (10 lb.in) Terminal screw - M3.5
	2 x 0.2...2.5 mm <sup>2</sup> solid wire
AWG	1 x 24 to 10

AWG	CURRENT (A)
10	5.00
12	4.38
14	3.75
16	3.13
18	2.50
20	1.88
22	1.25
24	0.63

NOTE: Use Cu Wire of 75 Dec. C Only..

**Models :**

**ON-Delay 896-6810 & 896-6816**  
**Star-Delta Starter Timer 896-6832, 896-6835 & 896-6838**  
**Signal OFF-Delay 896-6822 & 896-6829**

**Installation :**

DIN - Rail Mounting : The Timer should be mounted on 35 mm symmetrical DIN - Rail.

**On Delay Timer**

**896-6810 & 896-6816**

**Timing Diagram:**

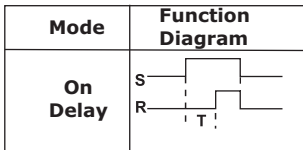

**STAR - DELTA START Timer:**

**RS Stock No 896-6835 & 896-6838**

**Timing Diagram:**

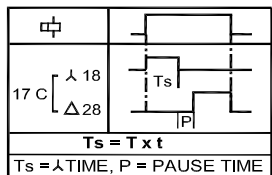

**Signal Off Delay Timer**

**896-6822 & 896-6829**

**Timing Diagram :**

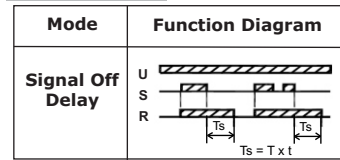

**Connection Diagrams :**

**896-6822 & 896-6829**

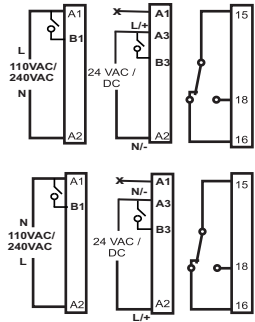

Do not apply more than 27VAC/DC to A3 terminal.

**Connection Diagrams :**

**896-6810**

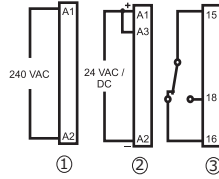

**896-6816**

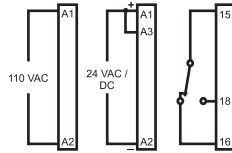

**896-6838 Un = 240VAC**

**896-6835 Un = 110VAC**

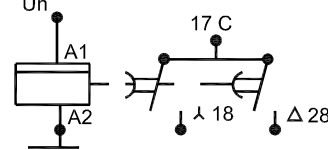

**Recommended Star - Delta Control Circuit :**

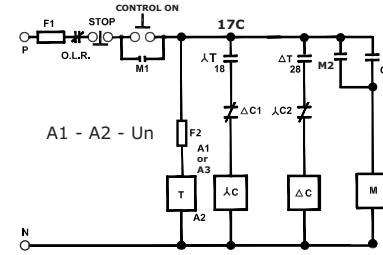

- 1) F1 - Mains Protection Fuse
- 2) F2 - Timer Protection Fuse
- 3) O.L.R - Over Load Relay
- 4) M1 - First 'NO' Contact of Main Contactor
- 5) M2 - Second 'NO' Contact of Main Contactor
- 6) M - Main Contactor for driving Motor
- 7) ΔC - Star Contactor
- 8) λC1 - 'NO' Contact of Star Contactor
- 9) λC2 - 'NC' Contact of Star Contactor
- 10) ΔC - Delta Contactor
- 11) λC1 - 'NC' Contact of Delta Contactor
- 12) λT - Star Contact of Timer (λ-Δ)
- 13) ΔT - Delta Contact of Timer (λ-Δ)
- 14) T - Star Delta Timer (λ-Δ)

**Caution :**

1. Always follow instructions stated in this product leaflet.
2. Before installation, check that the specifications agree with the intended application.
3. Installation to be done by skilled electrician.
4. Changing Range and Timing Presets in power ON condition when the On Delay period has already started, will have no effect. It has to be set before powering ON the timer.
5. If user wants to reset timer one way to do this is to switch off the timer & then set timing & range preset to required position. In this case, Timer will reset & will take new set time.
6. Setting of all the potentiometers should be in clockwise direction only.
7. Use 250 mA slow blow fuse (F2) in series with the above mentioned products.
8. The timers shall be placed in an enclosure that is minimum 200% of the size of the timer in the end use application. Use Cu wire of 75°C for connections.
9. The technical information provided in this document is correct at the time of going to the press. Product innovation being a continuous process, we reserve the right to make any alteration without prior notice.

**CONNECTION DIAGRAM FOR 896-6832**

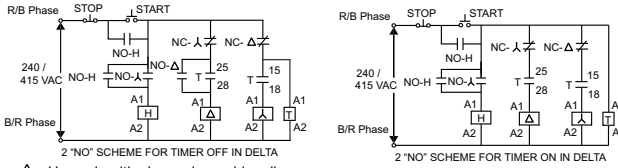

Use only with above given wiring diagram.

**Sensor Connection Diagrams For 896-6822 & 896-6829**

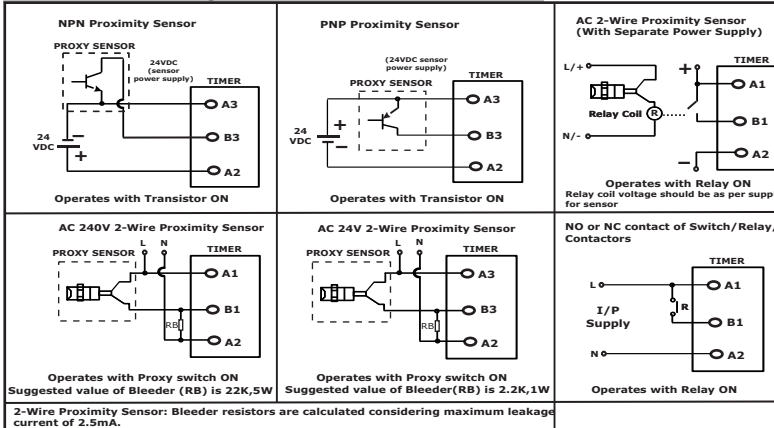

2-Wire Proximity Sensor: Bleeder resistors are calculated considering maximum leakage current of 2.5mA.

**Overall Dimension :**

**Base Mounting :**

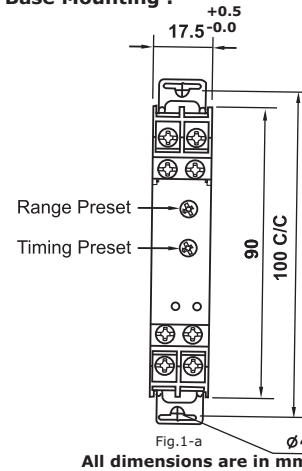

All dimensions are in mm

**Din Rail Mounting :**

