

Datasheet

Wall-Mount Industrial Socket-outlet

Stock No:
2144200



Image for reference only

Technical Characteristics

Rated Current:	16
Rated Voltage	100-130
Poles	3P (2P+T)
Clock Position	4h
Rated Frequency	50/60Hz
Insulating Resistance	>10MΩ@500Vdc
Dielectric Stength	2,5kV 60s
IP Protection Degree	IP67 (IEC / EN 60529)
Operating Temperature	-25°C/ 40°C
Glow Wire Test	850°C live parts supports /650°C other parts
Material	Housing: PA6/ABS
Product Standard	IEC/EN 60309-1, IEC/EN 60309-2

Datasheet

Wall-Mount Industrial Socket-outlet

Stock No: 24190-RSC

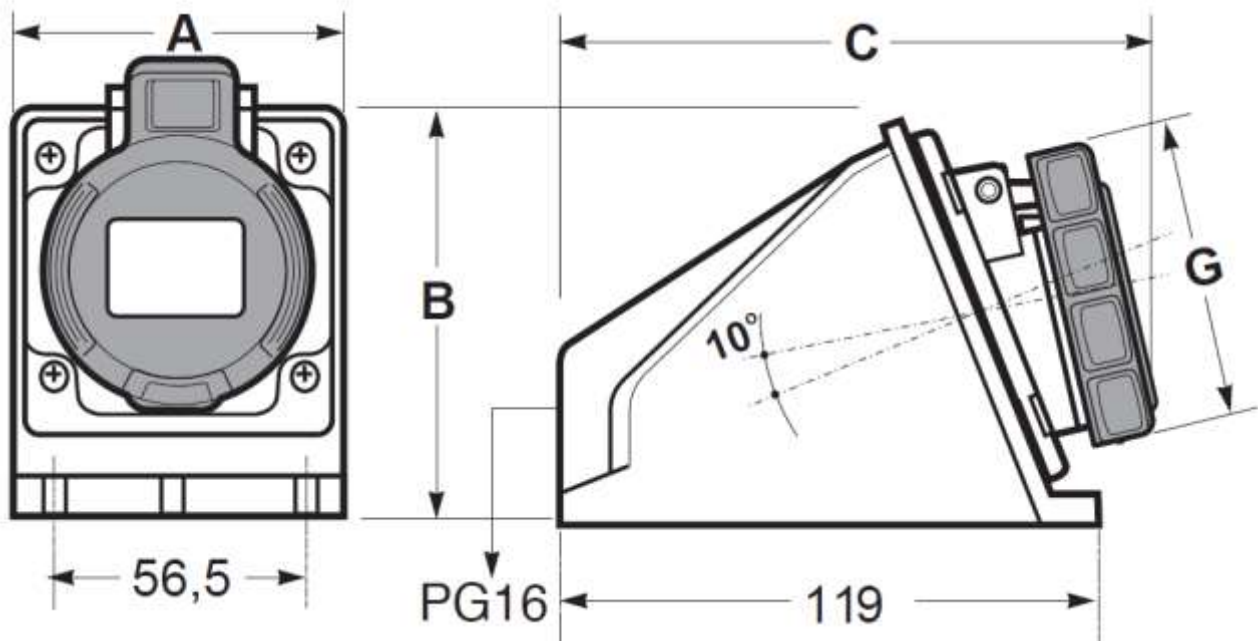

Dimensions in mm

A	B	C	D	E	F	G	ØK
81	97	158	-	-	48	70	-