

Datasheet

Industrial Adaptor

Stock No:
2144137



Image for reference only

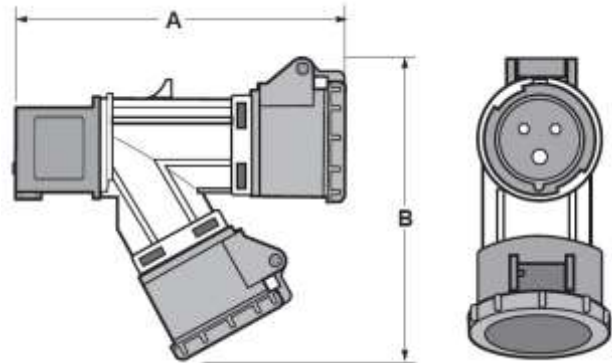

A:160 B:168 Dimensions in mm

Configuration

Inlet/Plug	IEC 60309 Plug 16A 2P+T 230V
Outlet / Socket-Outlet	2x IEC 60309 Socket-Outlet 16A 2P+T 230V

Technical Characteristics

Rated Current:	16
Rated Voltage	230
Poles	2P+T
IP Protection Degree	IP67 (IEC / EN 60529)
Glow Wire Test	850°C live parts supports /650°C other parts
Material	Housing: PA6/ABS
Product Standard	IEC/EN 60309-1, IEC/EN 60309-2
Note	-