







DATASHEET

2FG7

v1.1

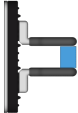
1. Datasheet

1.1. 2FG7

General Properties		Minimum	Typical	Maximum	Unit	
Payload force fit 		-	-	7 15.5	[kg] [lb]	
Payload form fit 		-	-	11 24.3	[kg] [lb]	
Total stroke		-	38 1.49	-	[mm] [inch]	
Grip width range *	External	Fingers inwards 	1 0.039	-	39 1.53	[mm] [inch]
		Fingers outwards 	35 1.37	-	73 2.87	[mm] [inch]
	Internal	Fingers inwards 	11 0.43	-	49 1.92	[mm] [inch]
		Fingers outwards 	45 1.77	-	83 3.26	[mm] [inch]
Gripping repeatability		-	+/- 0.1 +/- 0.004	-	[mm] [inch]	
Gripping force **		20	-	140	[N]	
Gripping force tolerance		-	-	+/-5	[N]	
Gripping speed ***		16	-	450	[mm/s]	
Gripping time (including brake activation) ****		-	200	-	[ms]	
Hold workpiece if power loss?		Yes				
Storage temperature		0 32	-	60 140	[°C] [°F]	
Motor		Integrated, electric BLDC				
IP Classification		IP67				
Clean room		ISO Class 5				
Dimensions [L x W x D]		144 x 90 x 71 5.67 x 3.54 x 2.79			[mm] [inch]	

General Properties	Minimum	Typical	Maximum	Unit
Weight	1.1 2.4			[kg] [lb]

* Silicone fingertips add 1 mm in each direction.

** The required current is 2000 mA, less current will result in less gripping force. See the [Force vs Current Graph](#).

*** Relatively from the gripping object (both arms).

**** At 4 mm stroke and 80 N. The typical value is 300 ms at 40 mm and 80 N.

Operating Conditions	Minimum	Typical	Maximum	Unit
Power supply	20	24	25	[V]
Current consumption	-	-	2000 *	[mA]
Operation temperature	5 41	- -	50 122	[°C] [°F]
Relative humidity (non-condensing)	0	-	95	[%]
Calculated operation life	30 000	-	-	[Hours]

* Automatically adapts to the current requirements when UR CB3 tool connector is used (600 mA).

Force vs Current Graph

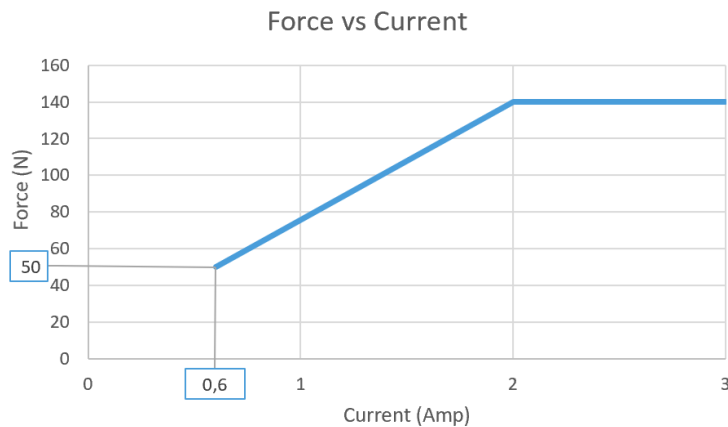

Force Sensor

The gripper has a force sensor in the finger on the connector side as shown in the figure below.



Consider the presence of the force sensor when the workpiece is aligned by using the fingers of the gripper or when the workpiece is picked sideways since the gravity can affect the force measurement.

In the latter case, orient the gripper so the finger with the sensor is on top. Make sure that the bottom finger touches the workpiece slightly before the top finger touches it, as shown in the figure below.

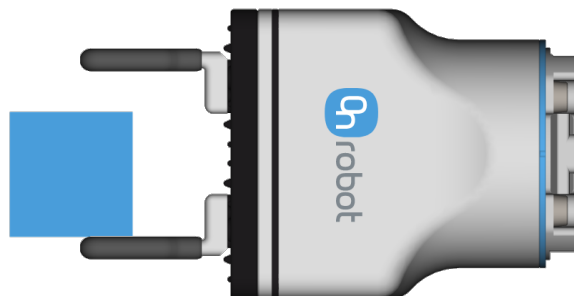

Fingers

The supplied fingers can be mounted in two different positions to achieve different gripping ranges.

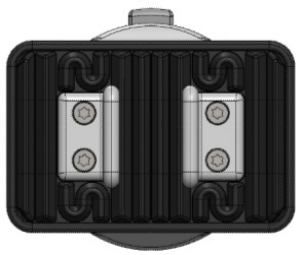
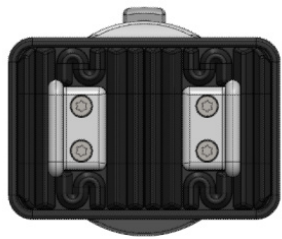
	Inwards	Outwards
		
External grip range [mm]	1-39	35-73
Internal grip range [mm]	11-49	45-83

The delivered finger length is 8.5 mm (L in the drawing below). If custom fingers are required, they can be made to fit the gripper according to the dimensions (mm)[inch] shown below. Use M4x8mm screws to attach the fingers.



NOTE:

If customized fingers are made, these must not touch the bellow.

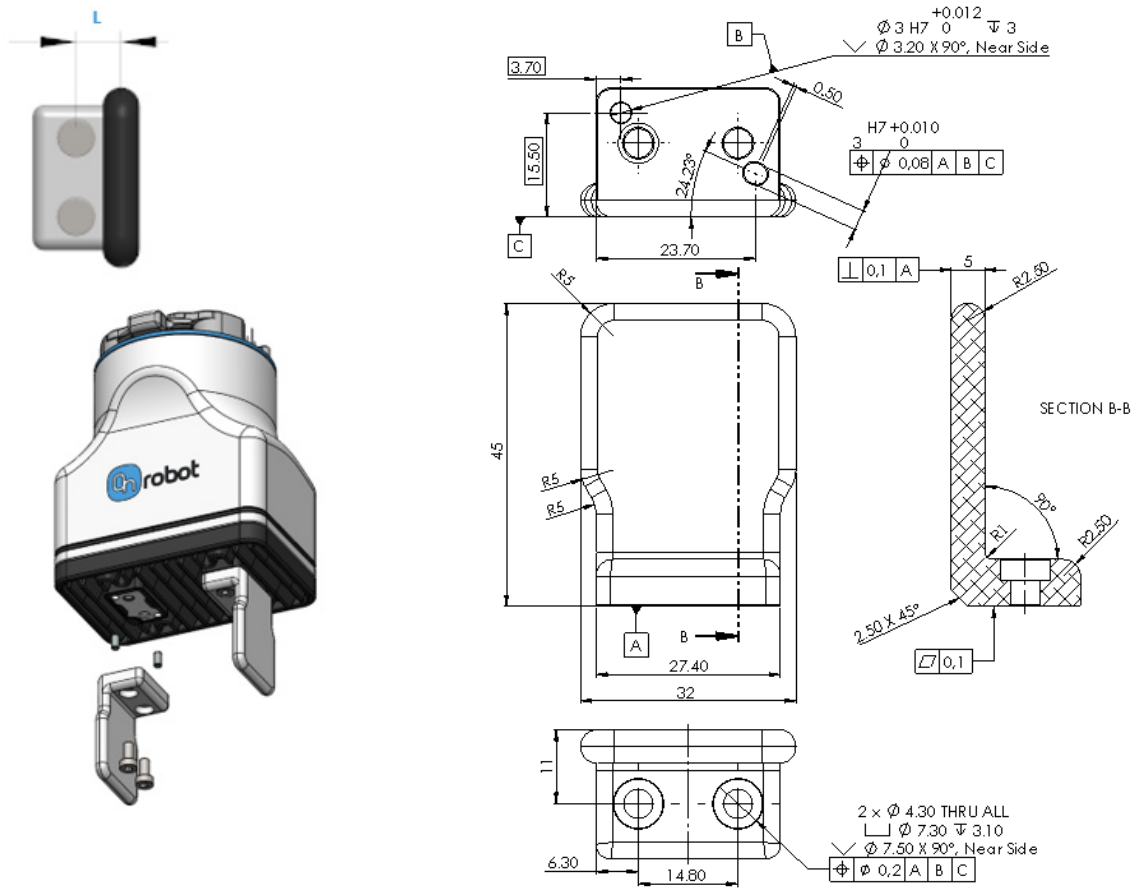

Finger Length vs Force

The graph below shows how the maximum achievable force decreases as the finger length increases in case of customized fingertips. The graph is valid for both types of individual lengths shown in the figure below.

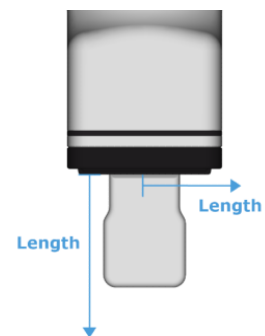
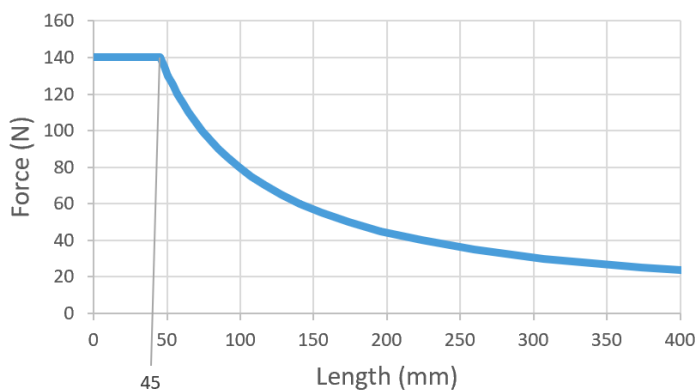

Types of Grips

In this document, we use the internal and external grip terms, which indicates how the tool grips the workpiece.

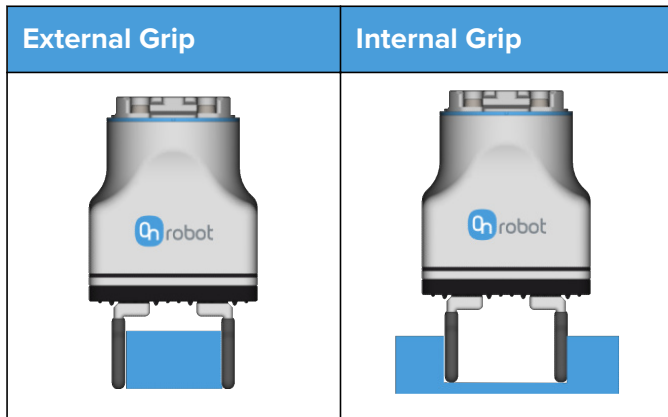

1.2. 2FG7

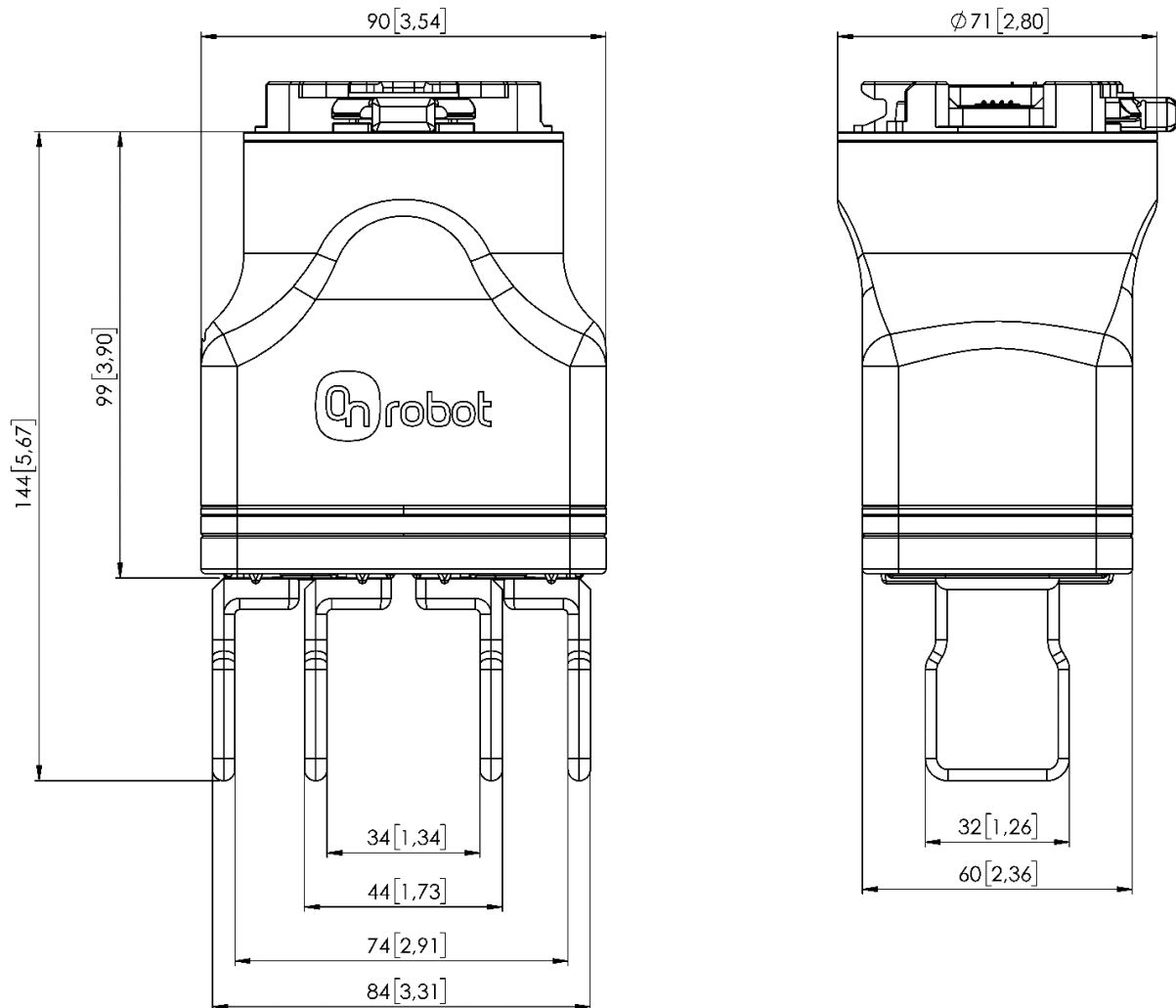

All dimensions are in mm and [inches].