

# AHM36I-S3QL014x12

AHS/AHM36 IO-Link Inox

**ABSOLUTE ENCODERS**

**SICK**  
Sensor Intelligence.

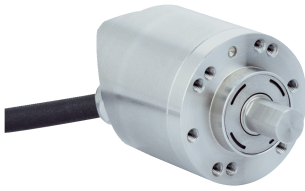

Illustration may differ



### Ordering information

Type	Part no.
AHM36I-S3QL014x12	1093781

Other models and accessories → [www.sick.com/AHS\\_AHM36\\_IO-Link\\_Inox](http://www.sick.com/AHS_AHM36_IO-Link_Inox)

### Detailed technical data

#### Performance

<b>Number of steps per revolution</b>	16,384 (max.)
<b>Number of revolutions</b>	4,096 (max.)
<b>Max. resolution (singleturn, multiturn)</b>	16,384 (14 bit), 4,096 (12 bit)
<b>Error limits G</b>	0.35° (at 20 °C) <sup>1)</sup>
<b>Repeatability standard deviation <math>\sigma_r</math></b>	0.2° (at 20 °C) <sup>2)</sup>

<sup>1)</sup> In accordance with DIN ISO 1319-1, position of the upper and lower error limit depends on the installation situation, specified value refers to a symmetrical position, i.e. deviation in upper and lower direction is the same.

<sup>2)</sup> In accordance with DIN ISO 55350-13; 68.3% of the measured values are inside the specified area.

#### Interfaces

<b>Communication interface</b>	IO-Link
<b>Communication Interface detail</b>	V1.1, COM3 (230,4 kBaud)
<b>Process data</b>	Position, speed
<b>Parameterising data</b>	Number of steps per revolution Number of revolutions PRESET Counting direction Sampling rate for speed calculation Unit for output of the speed value
<b>Status information</b>	Via status LED
<b>Initialization time</b>	2 s
<b>Cycle time</b>	≤ 3.2 ms

#### Electrical data

<b>Connection type</b>	Cable, 4-wire, universal, 3 m
<b>Supply voltage range</b>	18 V ... 30 V
<b>Power consumption</b>	≤ 1.5 W
<b>Reverse polarity protection</b>	✓
<b>MTTFd: mean time to dangerous failure</b>	145.6 years (EN ISO 13849-1)

Mechanical data

<b>Mechanical design</b>	Solid shaft, face mount flange
<b>Shaft diameter</b>	6 mm x 12 mm
<b>Shaft length</b>	12 mm
<b>Weight</b>	0.2 kg, relates to devices with male connector connection
<b>Shaft material</b>	Stainless steel
<b>Flange material</b>	Stainless steel
<b>Material, stator coupling</b>	Stainless steel
<b>Housing material</b>	Stainless steel
<b>Material, cable</b>	PUR
<b>Start up torque</b>	≤ 1 Ncm <sup>1)</sup>
<b>Operating torque</b>	≤ 1 Ncm <sup>1)</sup>
<b>Permissible Load capacity of shaft</b>	40 N / radial 20 N / axial
<b>Moment of inertia of the rotor</b>	2.5 gcm <sup>2</sup>
<b>Bearing lifetime</b>	3.6 x 10 <sup>8</sup> revolutions
<b>Angular acceleration</b>	≤ 500,000 rad/s <sup>2</sup>
<b>Operating speed</b>	≤ 6,000 min <sup>-1</sup>

<sup>1)</sup> At 20 °C.

Ambient data

<b>EMC</b>	According to EN 61000-6-2 and EN 61000-6-3
<b>Enclosure rating</b>	IP67 (IEC 60529) IP69K (IEC 60529)
<b>Permissible relative humidity</b>	90 % (Condensation not permitted)
<b>Operating temperature range</b>	-40 °C ... +85 °C
<b>Storage temperature range</b>	-40 °C ... +100 °C
<b>Resistance to shocks</b>	100 g, 6 ms (according to EN 60068-2-27)
<b>Resistance to vibration</b>	20 g, 10 Hz ... 2,000 Hz (according to EN 60068-2-6)

Classifications

<b>ECl@ss 5.0</b>	27270502
<b>ECl@ss 5.1.4</b>	27270502
<b>ECl@ss 6.0</b>	27270590
<b>ECl@ss 6.2</b>	27270590
<b>ECl@ss 7.0</b>	27270502
<b>ECl@ss 8.0</b>	27270502
<b>ECl@ss 8.1</b>	27270502
<b>ECl@ss 9.0</b>	27270502
<b>ETIM 5.0</b>	EC001486
<b>ETIM 6.0</b>	EC001486
<b>UNSPSC 16.0901</b>	41112113

### Dimensional drawing (Dimensions in mm (inch))

Solid shaft, face mount flange, cable outlet

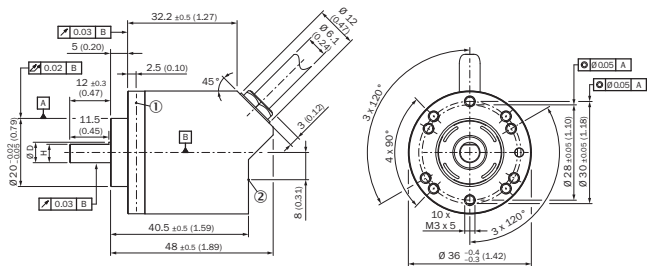

- ① Measuring point for operating temperature
- ② Measuring point for vibrations

### Proposed fitting

Solid shaft, face mount flange with flange adapter, centering collar D20 on D50 (BEF-FA-020-050-I, 2103985)

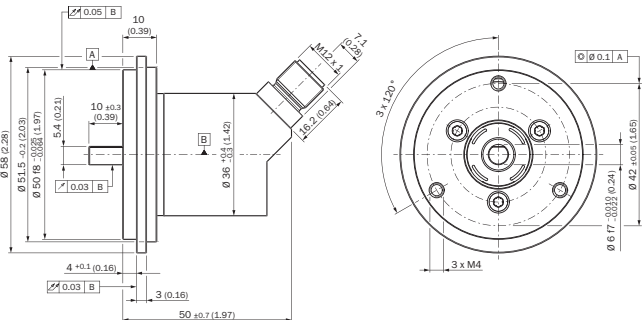

Order example for 6 mm shaft diameter: AHx36I-S3xx0xxxx + BEF-FA-020-050-I (adapter is not pre-assembled)

Solid shaft, face mount flange with flange adapter, centering collar D20 on D24 (BEF-FA-020-024-I, 2103982)

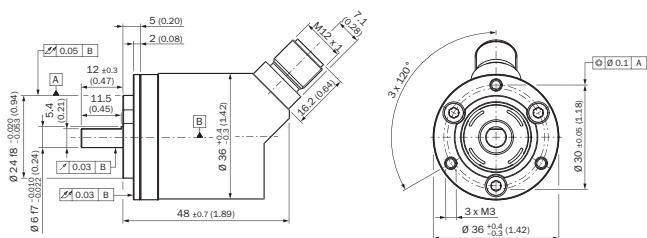

Order example for 6 mm shaft diameter: AHx36I-S3xx0xxxx + BEF-FA-020-024-I (adapter is not pre-assembled)

Solid shaft, face mount flange with flange adapter, centering collar D20 on D36, 2 mm high (BEF-FA-020-036-2-I, 2103984)

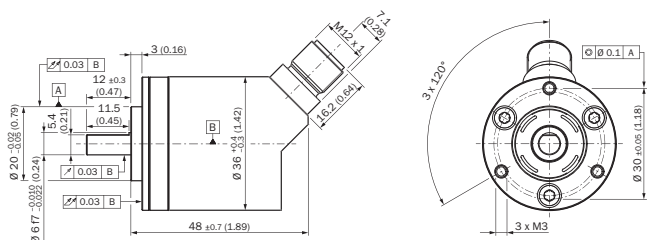

Order example for 6 mm shaft diameter: AHx36I-S3xx0xxxx + BEF-FA-020-036-2-I (adapter is not pre-assembled)

PIN assignment

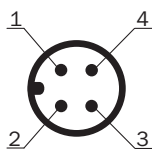







PIN	Wire color	Signal	Function
1	Brown	L+	Encoder supply voltage 18-30 V (+Us)
2	White	I/Q	Not connected - no function
3	Blue	L-	Encoder supply voltage 0 V (GND)
4	Black	C/Q	IO-Link communication

Recommended accessories

Other models and accessories → [www.sick.com/AHS\\_AHM36\\_IO-Link\\_Inox](http://www.sick.com/AHS_AHM36_IO-Link_Inox)

	Brief description	Type	Part no.
<b>Shaft adaptation</b>			
	Bellows coupling, shaft diameter 6 mm / 6 mm, maximum shaft offset: radial ± 0.25 mm, axial ± 0.4 mm, angular +/- 4°; max. speed 10,000 rpm, -30 °C to +120 °C, max. torque 80 Ncm; material: stainless steel bellows, aluminum hub	KUP-0606-B	5312981
	Bellows coupling, shaft diameter 6 mm / 10 mm, maximum shaft offset: radial ± 0.25 mm, axial ± 0.4 mm, angular +/- 4°; max. speed 10,000 rpm, -30 °C to +120 °C, max. torque 80 Ncm; material: stainless steel bellows, aluminum hub	KUP-0610-B	5312982
	Double loop coupling, shaft diameter 6 mm / 10 mm, max. shaft offset: radially +/- 2,5 mm, axially +/-3 mm, angle +/- 10 degrees;max. speed 3.000 rpm, -30 to +80 degrees Celsius, torsional spring stiffness of 25 Nm/rad	KUP-0610-D	5326697
	Spring washer coupling, shaft diameter 6 mm / 10 mm, Maximum shaft offset: radial +/- 0.3 mm, axial +/- 0.4 mm, angular +/- 2.5°; max. speed 12,000 rpm, -10° to +80 °C, max. torque 60 Ncm; material: aluminum flange, glass fiber-reinforced polyamide membrane and hardened steel coupling pin	KUP-0610-F	5312985
<b>Plug connectors and cables</b>			
	Head A: female connector, M12, 4-pin, straight Head B: Flying leads Cable: PVC, unshielded, 2 m This product is generally resistant to chemical cleaning agents (see ECOLAB). Please do not use cleaning agents of any other Kind., Not resistant against lactic acid & hydrogen peroxide (H2O2)	DOL-1204-G02MNI	6052613
	Head A: female connector, M12, 4-pin, straight Head B: Flying leads Cable: PP, unshielded, 2 m This product is generally resistant to chemical cleaning agents (see ECOLAB) and other chemical compounds such as H2O2 and CH2O2. Before permanent installation is carried out, the material's resistance to the cleaning agent being used must be checked., Resistant against lactic acid & hydrogen peroxide (H2O2)	DOL-1204-G02MRN	6058291
	Head A: female connector, M12, 4-pin, straight Head B: Flying leads Cable: PVC, unshielded, 5 m This product is generally resistant to chemical cleaning agents (see ECOLAB). Please do not use cleaning agents of any other Kind., Not resistant against lactic acid & hydrogen peroxide (H2O2)	DOL-1204-G05MNI	6052615

	Brief description	Type	Part no.
	Head A: female connector, M12, 4-pin, straight Head B: Flying leads Cable: PP, unshielded, 5 m This product is generally resistant to chemical cleaning agents (see ECOLAB) and other chemical compounds such as H2O2 and CH2O2. Before permanent installation is carried out, the material's resistance to the cleaning agent being used must be checked., Resistant against lactic acid & hydrogen peroxide (H2O2)	DOL-1204-G05MRN	6058476
	Head A: female connector, M12, 4-pin, straight Head B: Flying leads Cable: PVC, unshielded, 10 m This product is generally resistant to chemical cleaning agents (see ECOLAB). Please do not use cleaning agents of any other Kind., Not resistant against lactic acid & hydrogen peroxide (H2O2)	DOL-1204-G10MNI	6052617
	Head A: female connector, M12, 4-pin, straight Head B: Flying leads Cable: PP, unshielded, 10 m This product is generally resistant to chemical cleaning agents (see ECOLAB) and other chemical compounds such as H2O2 and CH2O2. Before permanent installation is carried out, the material's resistance to the cleaning agent being used must be checked., Resistant against lactic acid & hydrogen peroxide (H2O2)	DOL-1204-G10MRN	6058478
	Head A: female connector, M12, 4-pin, angled Head B: Flying leads Cable: PVC, unshielded, 2 m This product is generally resistant to chemical cleaning agents (see ECOLAB). Please do not use cleaning agents of any other Kind., Not resistant against lactic acid & hydrogen peroxide (H2O2)	DOL-1204-W02MNI	6052614
	Head A: female connector, M12, 4-pin, angled Head B: Flying leads Cable: PP, unshielded, 2 m This product is generally resistant to chemical cleaning agents (see ECOLAB) and other chemical compounds such as H2O2 and CH2O2. Before permanent installation is carried out, the material's resistance to the cleaning agent being used must be checked., Resistant against lactic acid & hydrogen peroxide (H2O2)	DOL-1204-W02MRN	6058474
	Head A: female connector, M12, 4-pin, angled Head B: Flying leads Cable: PVC, unshielded, 5 m This product is generally resistant to chemical cleaning agents (see ECOLAB). Please do not use cleaning agents of any other Kind., Not resistant against lactic acid & hydrogen peroxide (H2O2)	DOL-1204-W05MNI	6052616
	Head A: female connector, M12, 4-pin, angled Head B: Flying leads Cable: PP, unshielded, 5 m This product is generally resistant to chemical cleaning agents (see ECOLAB) and other chemical compounds such as H2O2 and CH2O2. Before permanent installation is carried out, the material's resistance to the cleaning agent being used must be checked., Resistant against lactic acid & hydrogen peroxide (H2O2)	DOL-1204-W05MRN	6058477
	Head A: female connector, M12, 4-pin, angled Head B: Flying leads Cable: PVC, unshielded, 10 m This product is generally resistant to chemical cleaning agents (see ECOLAB). Please do not use cleaning agents of any other Kind., Not resistant against lactic acid & hydrogen peroxide (H2O2)	DOL-1204-W10MNI	6052618
	Head A: female connector, M12, 4-pin, angled Head B: Flying leads Cable: PP, unshielded, 10 m This product is generally resistant to chemical cleaning agents (see ECOLAB) and other chemical compounds such as H2O2 and CH2O2. Before permanent installation is carried out, the material's resistance to the cleaning agent being used must be checked., Resistant against lactic acid & hydrogen peroxide (H2O2)	DOL-1204-W10MRN	6058479

	Brief description	Type	Part no.
	Head A: female connector, M12, 4-pin, angled Head B: male connector, M12, 4-pin, straight Cable: PVC, unshielded, 2 m This product is generally resistant to chemical cleaning agents (see ECOLAB). Please do not use cleaning agents of any other Kind., Not resistant against lactic acid & hydrogen peroxide (H2O2)	DSL-1204-B02MNI	6052633
	Head A: female connector, M12, 4-pin, angled Head B: male connector, M12, 4-pin, straight Cable: PP, unshielded, 2 m This product is generally resistant to chemical cleaning agents (see ECOLAB) and other chemical compounds such as H2O2 and CH2O2. Before permanent installation is carried out, the material's resistance to the cleaning agent being used must be checked., Resistant against lactic acid & hydrogen peroxide (H2O2)	DSL-1204-B02MRN	6058502
	Head A: female connector, M12, 4-pin, angled Head B: male connector, M12, 4-pin, straight Cable: PVC, unshielded, 5 m This product is generally resistant to chemical cleaning agents (see ECOLAB). Please do not use cleaning agents of any other Kind., Not resistant against lactic acid & hydrogen peroxide (H2O2)	DSL-1204-B05MNI	6052634
	Head A: female connector, M12, 4-pin, angled Head B: male connector, M12, 4-pin, straight Cable: PP, unshielded, 5 m This product is generally resistant to chemical cleaning agents (see ECOLAB) and other chemical compounds such as H2O2 and CH2O2. Before permanent installation is carried out, the material's resistance to the cleaning agent being used must be checked., Resistant against lactic acid & hydrogen peroxide (H2O2)	DSL-1204-B05MRN	6058503
	Head A: female connector, M12, 4-pin, straight Head B: male connector, M12, 4-pin, straight Cable: PVC, unshielded, 2 m This product is generally resistant to chemical cleaning agents (see ECOLAB). Please do not use cleaning agents of any other Kind., Not resistant against lactic acid & hydrogen peroxide (H2O2)	DSL-1204-G02MNI	6052630
	Head A: female connector, M12, 4-pin, straight Head B: male connector, M12, 4-pin, straight Cable: PP, unshielded, 2 m This product is generally resistant to chemical cleaning agents (see ECOLAB) and other chemical compounds such as H2O2 and CH2O2. Before permanent installation is carried out, the material's resistance to the cleaning agent being used must be checked., Resistant against lactic acid & hydrogen peroxide (H2O2)	DSL-1204-G02MRN	6058499
	Head A: female connector, M12, 4-pin, straight Head B: male connector, M12, 4-pin, straight Cable: PVC, unshielded, 5 m This product is generally resistant to chemical cleaning agents (see ECOLAB). Please do not use cleaning agents of any other Kind., Not resistant against lactic acid & hydrogen peroxide (H2O2)	DSL-1204-G05MNI	6052631
	Head A: female connector, M12, 4-pin, straight Head B: male connector, M12, 4-pin, straight Cable: PP, unshielded, 5 m This product is generally resistant to chemical cleaning agents (see ECOLAB) and other chemical compounds such as H2O2 and CH2O2. Before permanent installation is carried out, the material's resistance to the cleaning agent being used must be checked., Resistant against lactic acid & hydrogen peroxide (H2O2)	DSL-1204-G05MRN	6058500

## SICK AT A GLANCE

SICK is one of the leading manufacturers of intelligent sensors and sensor solutions for industrial applications. A unique range of products and services creates the perfect basis for controlling processes securely and efficiently, protecting individuals from accidents and preventing damage to the environment.

We have extensive experience in a wide range of industries and understand their processes and requirements. With intelligent sensors, we can deliver exactly what our customers need. In application centers in Europe, Asia and North America, system solutions are tested and optimized in accordance with customer specifications. All this makes us a reliable supplier and development partner.

Comprehensive services complete our offering: SICK LifeTime Services provide support throughout the machine life cycle and ensure safety and productivity.

For us, that is “Sensor Intelligence.”

## WORLDWIDE PRESENCE:

Contacts and other locations –[www.sick.com](http://www.sick.com)