

VS8 Sensor Series

Instruction Manual

Original Instructions
201958 Rev. B
31 May 2018
© Banner Engineering Corp. All rights reserved



201958

Contents

1 Product Description	3
1.1 Models	3
1.2 Features	4
2 Sensor Installation	5
2.1 Wiring Diagrams	5
3 Sensor Configuration	6
3.1 Remote Configuration – 4-Pin Models	6
3.2 Two-Point Static Background Suppression	6
3.3 One-Point Static Background Suppression	7
3.4 Dynamic Background Suppression	8
3.5 Two-Point Static Opposed and Retroreflective	9
3.6 Dynamic Opposed and Retroreflective	10
3.7 Select Light Operate/Dark Operate – 4-Pin Models	11
4 Specifications	12
4.1 Dimensions	12
5 Performance Curves	13
5.1 Beam Spot Sizes	13
6 Accessories	14
6.1 Cordsets for VS8 Models with Suffix Q	14
6.2 Cordsets for VS8 Models with Suffix Q3	14
6.3 Cordsets for VS8 Models with Suffix Q5	14
6.4 Brackets	15
6.5 Retroreflectors	16
7 Banner Engineering Corp. Limited Warranty	17

1 Product Description

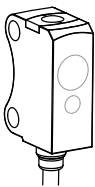

- Miniature sensor for installation in the smallest of spaces
- Red laser models provide bright, precise laser light spot for optimum small part detection
- High switching frequency for detection in even the fastest processes
- User-friendly operation using electronic push button or remote input provides reliable and precise detection
- Red laser, Red LED, and Blue LED types available to match sensing beam to application
- Robust, glass-fiber-reinforced plastic housing
- PNP or NPN output, depending on model



WARNING: Not To Be Used for Personnel Protection

Never use this device as a sensing device for personnel protection. Doing so could lead to serious injury or death. This device does not include the self-checking redundant circuitry necessary to allow its use in personnel safety applications. A sensor failure or malfunction can cause either an energized or de-energized sensor output condition.

1.1 Models

Opposed Models				
Model	Sensing Mode	Range	Output	Connection
VS8LEJ	Red Laser Emitter with Beam Inhibit	0 m to 3 m (0 in to 9.8 ft)	-	2 m (6.5 ft) unterminated 4-wire PUR cable
VS8LEJQ			-	200 mm (7.8 in) PUR cable with a 4-pin M8/Pico-style male quick disconnect (QD)
VS8EAPR	Receiver		PNP	2 m (6.5 ft) unterminated 4-wire PUR cable
VS8EANR				
VS8EAPRQ			PNP	200 mm (7.8 in) PUR cable with a 4-pin M8/Pico-style male quick disconnect (QD)
VS8EANRQ			NPN	

Retroreflective Models				
Model	Sensing Mode	Range	Output	Connection
VS8EAPLP	Red LED Retro Reflective	0.1 m to 1.6 m (3.9 in to 62.9 in) with BRT-2X2	PNP	2 m (6.5 ft) unterminated 4-wire PUR cable
VS8EANLP			NPN	
VS8EAPLPQ			PNP	200 mm (7.8 in) PUR cable with a 4-pin M8/Pico-style male quick disconnect (QD)
VS8EANLPQ			NPN	
VS8EAPLLP	Red Laser Retro Reflective	0.1 m to 2 m (3.9 in to 78.7 in) with BRT-51X51BM	PNP	2 m (6.5 ft) unterminated 4-wire PUR cable
VS8EANLLP			NPN	
VS8EAPLLPQ			PNP	200 mm (7.8 in) PUR cable with a 4-pin M8/Pico-style male quick disconnect (QD)
VS8EANLLPQ			NPN	

Background Suppression Models				
Model ¹	Sensing Mode	Range	Output	
VS8EAPAF70	Red LED, Adjustable Background Suppression	5 mm to 70 mm (0.2 in to 2.8 in)	PNP	2 m (6.5 ft) unterminated 4-wire PUR cable
VS8EANAF70			NPN	
VS8EAPLAF70	Red Laser, Adjustable Background Suppression	6 mm to 70 mm (0.24 in to 2.8 in)	PNP	
VS8EANLAF70			NPN	
VS8APFF30B	Blue LED, Fixed 30 mm Background Suppression	2 mm to 30 mm (0.08 in to 1.18 in)	PNP	
VS8ANFF30B			NPN	
VS8APFF15	Red LED, Fixed 15 mm Background Suppression	2 mm to 15 mm (0.08 in to 0.59 in)	PNP	
VS8ANFF15			NPN	
VS8APFF30	Red LED, Fixed 30 mm Background Suppression	2 mm to 30 mm (0.08 in to 1.18 in)	PNP	
VS8ANFF30			NPN	
VS8APFF50	Red LED, Fixed 50 mm Background Suppression	2 mm to 50 mm (0.08 in to 1.97 in)	PNP	
VS8ANFF50			NPN	

1.2 Features

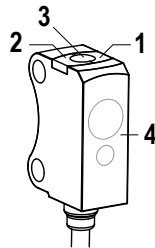

Figure 1. VS8 Sensor Features

Features

1. Green Indicator
2. Amber Indicator
3. TEACH Button - Laser Adjustable Field (LAF), Adjustable Field (AF), Polar Retro (LP), and Receiver (R) Models
4. Optical Window

¹

- To order the 200 mm (7.8 in) PUR cable model with a 4-pin M8/Pico-style quick disconnect, add suffix "Q" to the model number. For example, VS8EAPAF70Q. Only available for AF and LAF models.
- To order the 200 mm (7.8 in) PUR cable model with a 3-pin M8/Pico-style quick disconnect, add suffix "Q3" to the model number. For example, VS8APFF15Q3. Only available for FF models.
- To order the 200 mm (7.8 in) PUR cable model with a 4-pin M12/Euro-style quick disconnect, add suffix "Q5" to the model number. For example, VS8EAPAF70Q5. Only available for AF and LAF models.

2 Sensor Installation

Install the sensor so the object to be detected moves horizontally to the sensor.

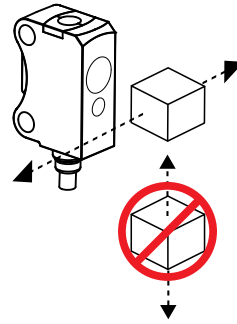
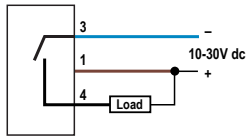

Figure 2. VS8 Sensor Installation

2.1 Wiring Diagrams

3-Pin NPN Models



3-Pin PNP Models

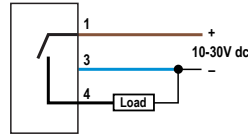

Key

- 1. Brown
- 2. White
- 3. Blue
- 4. Black

4-Pin NPN Models

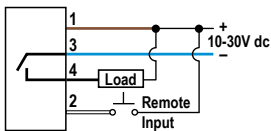

4-Pin PNP Models

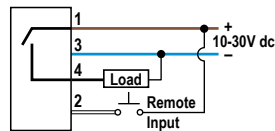

Opposed Mode Emitters

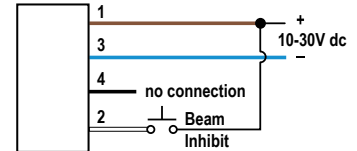

Note: All 4-pin and cabled models have a remote input on the white wire (pin-2).

3 Sensor Configuration

- *Expert™* 4-pin background suppression, retroreflective, and opposed mode receiver models are configurable using either the sealed push button or the remote input wire.
- 3-pin fixed field and opposed mode emitter models require no user adjustments.
- The remote input wire (pin-2/white wire) is used to select light or dark operate or perform the desired TEACH method. Pulse durations for the remote input wire correspond to the indicated press durations of the push button.

3.1 Remote Configuration – 4-Pin Models

The remote input wire (pin-2/white wire) is used to select light or dark operate, or perform the desired TEACH method. Closing and opening times for the remote input wire correspond to the indicated press/hold durations of the push button.

3.2 Two-Point Static Background Suppression

Two-point TEACH sets a single switch point. The sensor sets the switch point between two taught target distances, relative to the shifted origin location.

1. Present the target.

Method	Action	Result
Push Button	Present the first target. The sensor-to-target distance must be within the sensor's range.	N/A
Remote Input		

2. Start TEACH mode.

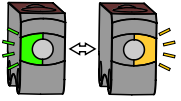
Method	Action	Result
Push Button	Press and hold push button > 3 seconds.	 BOTH LEDs FLASHING ALTERNATING
Remote Input	Pulse remote input wire > 3 seconds.	

3. Present the background or second target.

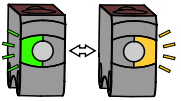
Method	Action	Result
Push Button	Present the background or second target. The sensor-to-target distance must be within the sensor's range.	 BOTH LEDs FLASHING ALTERNATING
Remote Input		

4. Configure the sensor.

Method	Action	Result
Push Button	Press push button > 1 second.	Sensor returns to normal operation.
Remote Input	Pulse remote input wire > 1 second.	

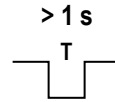
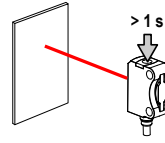

3.3 One-Point Static Background Suppression

One-point TEACH sets a single switch point. The sensor sets the switch point just behind the taught target distance.

1. Present the target.

Method	Action	Result
Push Button	Present the target. The sensor-to-target distance must be within the sensor's range.	N/A
Remote Input		

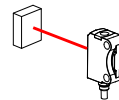

2. Start TEACH mode.

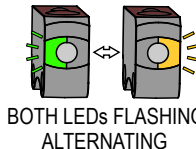
Method	Action	Result
Push Button	Press and hold push button > 3 seconds.	
Remote Input	Pulse remote input wire > 3 seconds.	

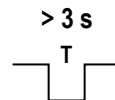
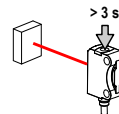

3. Configure the sensor.

Method	Action	Result
Push Button	Press push button > 1 second.	Sensor returns to normal operation.

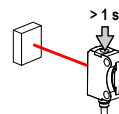

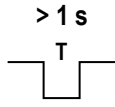
Method	Action	Result
Remote Input	Pulse remote input wire > 1 second.	

3.4 Dynamic Background Suppression

Dynamic TEACH sets a single switch point during machine run conditions. Dynamic TEACH is recommended for applications where a machine or process may not be stopped for teaching. The sensor takes multiple samples and the switch point is set just behind the farthest taught target distance, accounting for a static background.

1. Present the target.

Method	Action	Result
Push Button	Present the first target. The sensor-to-target distance must be within the sensor's range.	N/A
Remote Input		

2. Start TEACH mode.

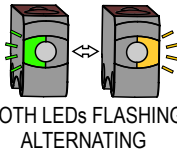
Method	Action	Result
Push Button	Press and hold push button > 3 seconds.	
Remote Input	Pulse remote input wire > 3 seconds.	

3. Configure the sensor.

Method	Action	Result
Push Button	Press and hold push button > 1 cycle of operation.	Sensor returns to normal operation.

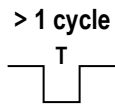
Method	Action	Result
Remote Input	Pulse remote input wire > 1 cycle of operation.	

3.5 Two-Point Static Opposed and Retroreflective

Two-point TEACH for Opposed and Retroreflective modes sets a single switching level. The sensor sets the switching level between the blocked and unblocked conditions.

- Align the sensor.

Method	Action	Result
Push Button	Align the emitter/receiver or sensor/retroreflector. The beam path should not be blocked.	N/A
Remote Input		

- Start TEACH mode.

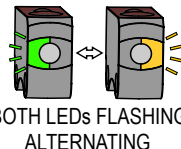
Method	Action	Result
Push Button	Press and hold push button > 3 seconds.	
Remote Input	Pulse remote input wire > 3 seconds.	

- Present the target.

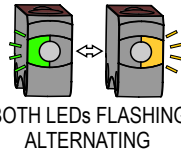
Method	Action	Result
Push Button	Present the target. The beam path should be blocked by the target.	
Remote Input		

- Configure the sensor.

Method	Action	Result
Push Button	Press and hold push button > 1 second.	Sensor returns to normal operation.
Remote Input	Pulse remote input wire > 1 second.	

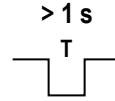
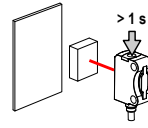

3.6 Dynamic Opposed and Retroreflective

Dynamic TEACH for Opposed and Retroreflective modes sets a single switching level during machine run conditions. Dynamic TEACH is recommended for applications where a machine or process may not be stopped for teaching. The sensor takes multiple samples and the switching level is set between the blocked and unblocked conditions.

1. Present the target.

Method	Action	Result
Push Button	Present the target. The beam path should be blocked by the target.	N/A
Remote Input		

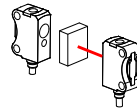

2. Start TEACH mode.

Method	Action	Result
Push Button	Press and hold push button > 3 seconds.	
Remote Input	Pulse remote input wire > 3 seconds.	

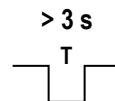
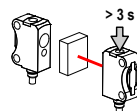

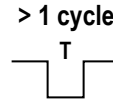
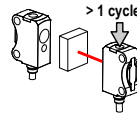

3. Configure the sensor.

Method	Action	Result
Push Button	Press and hold push button > 1 cycle of operation.	Sensor returns to normal operation.
Remote Input	Pulse remote input wire > 1 cycle of operation.	



3.7 Select Light Operate/Dark Operate – 4-Pin Models

Change the sensor operation to light operate or dark operate for the desired application. Use either the button or the remote input wire procedure to configure the sensor.

Method	Action	Result
Push Button	<p>Press and hold the button for longer than 10 seconds.</p> <p>Press the button until the desired operation is selected, then release the button and wait 10 seconds.</p>	<p>1. The green LED flashes to show that the sensor is in LO/DO select mode.</p>  <p>GREEN LED FLASHING</p> <p>2. The amber LED indicates the selected operation mode.</p> <p>Light Operate</p>  <p>GREEN LED FLASHING AMBER LED ON</p> <p>Dark Operate</p>  <p>GREEN LED FLASHING AMBER LED OFF</p> <p>3. The sensor is configured and returns to normal operation.</p>
Remote Input Wire	<p>Pulse the remote input wire to + V dc for longer than 10 seconds.</p> <p>Pulse the remote input wire to + V dc for 4 to 1000 ms until the desired operation is selected and wait 10 seconds.</p>	

> 10 s



4-1000 ms



4 Specifications

Supply Voltage and Current

LED models: 10 V dc to 30 V dc (10% max. ripple) at less than 20 mA, exclusive of load
Laser models: 10 V dc to 30 V dc (10% max. ripple) at less than 12 mA, exclusive of load

Supply Protection Circuitry

Protected against reverse polarity and short-circuit

Output Protection Circuitry

Protected against output short-circuit, continuous overload, and false pulse on power-up

Output Configuration

Retroreflective and Background Suppression Models: Single PNP or NPN on pin 4 (black wire) with remote input on pin 2 (white wire)
Opposed Mode Receivers only: Single PNP or NPN on pin 4 (black wire) with remote input on pin 2 (white wire)

Output Response Time

500 μ s

Output Rating

50 mA

Switching Frequency

\leq 1000 Hz

Delay Before Power-Up

< 300 ms

Laser Classifications

All Models: Class 1; wavelength: 655 nm; frequency: 5 kHz; pulse duration: 3.2 μ s; limit value pulse: \leq 2.3 mW. Reference IEC 60825-1:2001, Section 8.2.

All Models: Complies with 21 CFR 1040.10 and 1040.11 except for deviations pursuant to laser Notice No. 50 dated June 24, 2007.

Blue LED Models: Risk Group 2; possibly hazardous optical radiation emitted from this product. Do not stare at the operating lamp. May be harmful to the eyes. (EN62471)

Opposed Mode Model Adjustments

Push button teach input (Receivers)
 Remote wire teach input (Receivers)
 Remote wire beam inhibit (Emitters)

Indicators

2 LED indicators on sensor top
Green on: Power on
Amber on: Output conducting

Emitter LED Wavelength

Red LED models: 650 nm
Blue LED models: 450 nm
Laser models: 655 nm

Effective Beam

5.5 mm
 This can be adjusted without an aperture by teaching the sensor

Connections

2 m (6.5 ft) unterminated 4-wire PUR cable or 200 mm (7.8 in) PUR cable with a 3- or 4-pin M8/Pico-style or 4-pin M12/Euro-style male quick disconnect, depending on model
 Models ending in suffix "Q", "Q3", or "Q5" must be used with a UL recognized cordset R/C (CYJV2)
 Search p/n 201958 at www.bannerengineering.com to view the Instruction Manual for more information on cordsets

Construction

Housing, cable: PUR
 Front screen: PMMA

Operating Conditions

LED models: -20 °C to +60 °C (-4 °F to +140 °F)
Laser models: -20 °C to +50 °C (-4 °F to +122 °F)
Storage Temperature: -20 °C to +80 °C (-4 °F to +176 °F)
UL Operating Temperature: -20 °C to +30 °C (-4 °F to +86 °F)

Chemical Compatibility

ECOLAB® certified (2 m cabled models only)

Environmental Rating

IEC IP67

Certifications



4.1 Dimensions

All measurements are listed in millimeters [inches], unless noted otherwise.

Sensor with Bracket (SMBVS8DT)

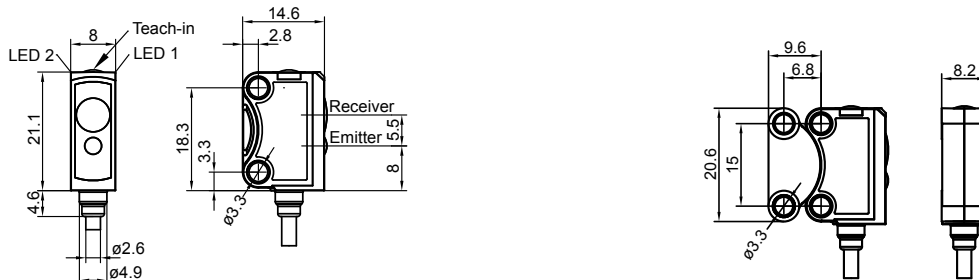

5 Performance Curves

5.1 Beam Spot Sizes

Opposed Mode

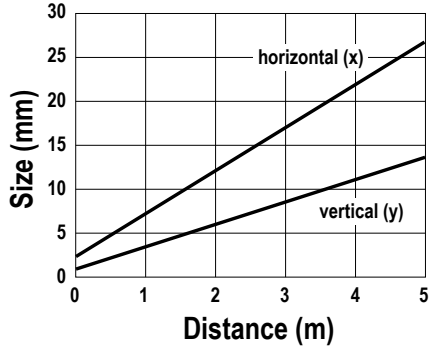

Retroreflective

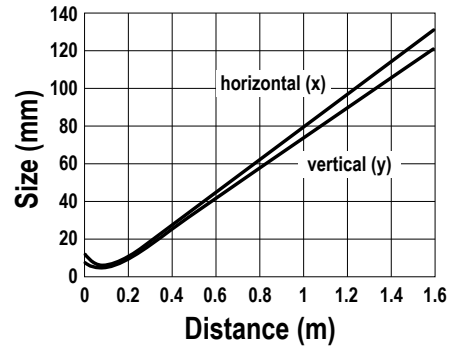

Laser Retroreflective

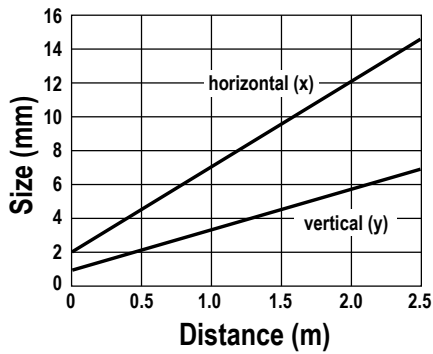

Fixed Field Background Suppression with Blue LED

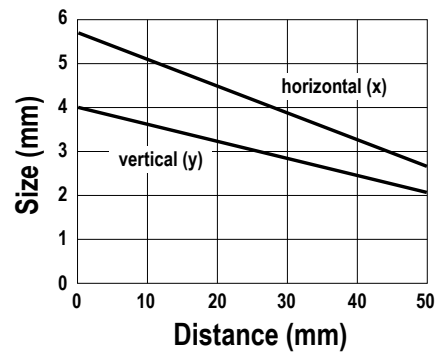

Fixed Field Background Suppression

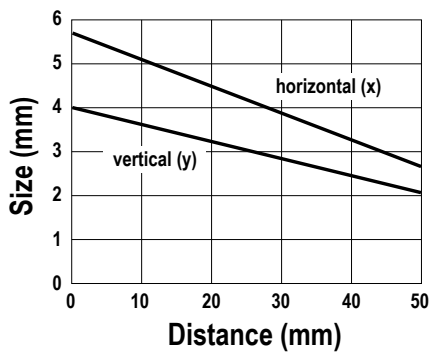

Adjustable Field Background Suppression

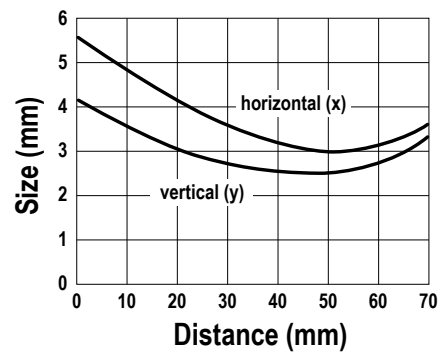

6 Accessories

6.1 Cordsets for VS8 Models with Suffix Q

All measurements are listed in millimeters, unless noted otherwise.

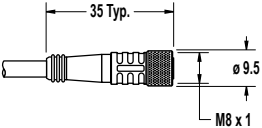
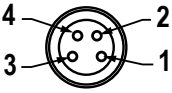
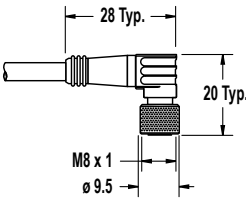
4-Pin Threaded M8/Pico-Style Cordsets				
Model	Length	Style	Dimensions	Pinout (Female)
PKG4M-2	2 m (6.56 ft)	Straight		 <p>1 = Brown 2 = White 3 = Blue 4 = Black</p>
PKG4M-5	5 m (16.4 ft)			
PKG4M-9	9 m (29.5 ft)			
PKW4M-2	2 m (6.56 ft)	Right Angle		
PKW4M-5	5 m (16.4 ft)			
PKW4M-9	9 m (29.5 ft)			

6.2 Cordsets for VS8 Models with Suffix Q3

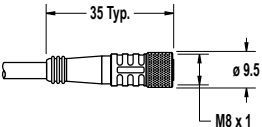
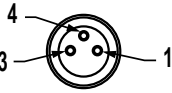
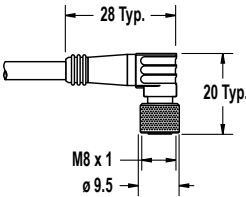
3-Pin Threaded M8/Pico-Style Cordsets				
Model	Length	Style	Dimensions	Pinout (Female)
PKG3M-2	2 m (6.56 ft)	Straight		 <p>1 = Brown 3 = Blue 4 = Black</p>
PKG3M-5	5 m (16.40 ft)			
PKG3M-7	7 m (22.97 ft)			
PKG3M-9	9 m (29.53 ft)			
PKW3M-2	2 m (6.56 ft)	Right-Angle		
PKW3M-5	5 m (16.40 ft)			
PKW3M-9	9 m (29.53 ft)			

6.3 Cordsets for VS8 Models with Suffix Q5

All measurements are listed in millimeters, unless noted otherwise.

4-Pin Threaded M12/Euro-Style Cordsets

Cable: PVC jacket, PUR (polyurethane) connector body, nickel-plated brass coupling nut

Conductors: 22 AWG, gold-plated contacts

Conductors: 22 AWG, gold-plated contacts

Voltage/Current Rating: 250 V ac/dc, 4.0 A

Temperature: -40 °C to +105 °C (-40 °F to +221 °F)

Environmental Rating: IP67/IP69K

4-Pin Threaded M12/Euro-Style Cordsets				
Model	Length	Style	Dimensions	Pinout (Female)
MQDC-406	1.83 m (6 ft)	Straight		<p>1 = Brown 2 = White 3 = Blue 4 = Black</p>
MQDC-415	4.57 m (15 ft)			
MQDC-430	9.14 m (30 ft)			
MQDC-450	15.2 m (50 ft)			

6.4 Brackets

SMBVS8RA

- Right-angle bracket
- 3.1 mm stainless steel

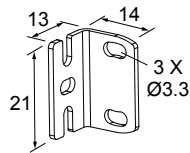

SMBVS8DT

- Dovetail clamp bracket
- Adjustable $\pm 10^\circ$
- Material: PBT

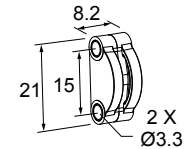

SMBQ12A

- Adjustable right-angle bracket
- 20-ga. 300 series stainless steel

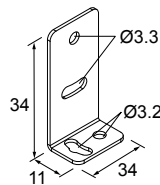

Hole center spacing: A to B = 7.6

Hole size: A = 3.5 x 8.1, B = \varnothing 3.2

SMBQ12T

- Right-angle bracket
- 20-ga. 300 series stainless steel

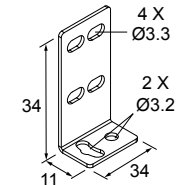

Hole center spacing: A to B = 7.6

Hole size: A = 3.5 x 8.1, B = \varnothing 3.2

SMBQ20FA

- Includes 3/8-16 X 2 in Socket Head Cap Screw (SHCS)
- 304 stainless steel



6.5 Retroreflectors

BRT-10BM

- Round, acrylic target
- Reflectivity Factor: 1.0
- Temperature: -20 °C to +60 °C (-4 °F to +140 °F)
- Micro-prism geometry
- Size: 10 mm diameter
- Reflective area: $\phi 10$ mm

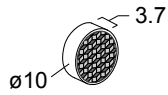

BRT-35X35BM

- Square, acrylic target
- Reflectivity Factor: 1.2
- Temperature: -20 °C to +60 °C (-4 °F to +140 °F)
- Micro-prism geometry
- Approximate size: 35 mm x 35 mm

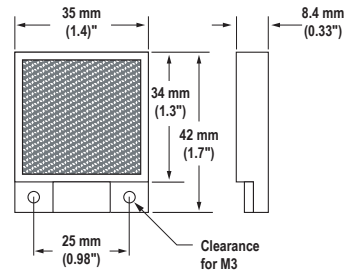

BRT-11X11M

- Square, acrylic target
- Reflectivity Factor: 1.2
- Temperature: -20 °C to +60 °C (-4 °F to +140 °F)
- Micro-prism geometry
- Approximate size: 11 mm x 11 mm

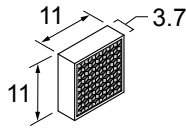

BRT-40X18A

- Rectangular, acrylic target
- Reflectivity Factor: 1.0
- Temperature: -20 °C to +60 °C (-4 °F to +140 °F)
- Approximate size: 18 mm x 50 mm

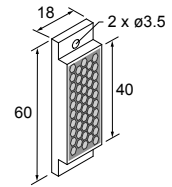

Note: For maximum adhesion of all tape products, surfaces must be clean.

Model	Reflectivity Factor	Maximum Temperature	Size
BRT-TVHG-2X2	0.8	+60 °C (+140 °F)	50 x 50 mm

These are sealed micro-prism style pieces and may not be cut.

Model	Reflectivity Factor	Maximum Temperature	Size
BRT-THG-2-100	0.7	+60 °C (+140 °F)	50 mm (2 in) wide, 2.5 m (100 in) long

7 Banner Engineering Corp. Limited Warranty

Banner Engineering Corp. warrants its products to be free from defects in material and workmanship for one year following the date of shipment. Banner Engineering Corp. will repair or replace, free of charge, any product of its manufacture which, at the time it is returned to the factory, is found to have been defective during the warranty period. This warranty does not cover damage or liability for misuse, abuse, or the improper application or installation of the Banner product.

THIS LIMITED WARRANTY IS EXCLUSIVE AND IN LIEU OF ALL OTHER WARRANTIES WHETHER EXPRESS OR IMPLIED (INCLUDING, WITHOUT LIMITATION, ANY WARRANTY OF MERCHANTABILITY OR FITNESS FOR A PARTICULAR PURPOSE), AND WHETHER ARISING UNDER COURSE OF PERFORMANCE, COURSE OF DEALING OR TRADE USAGE.

This Warranty is exclusive and limited to repair or, at the discretion of Banner Engineering Corp., replacement. **IN NO EVENT SHALL BANNER ENGINEERING CORP. BE LIABLE TO BUYER OR ANY OTHER PERSON OR ENTITY FOR ANY EXTRA COSTS, EXPENSES, LOSSES, LOSS OF PROFITS, OR ANY INCIDENTAL, CONSEQUENTIAL OR SPECIAL DAMAGES RESULTING FROM ANY PRODUCT DEFECT OR FROM THE USE OR INABILITY TO USE THE PRODUCT, WHETHER ARISING IN CONTRACT OR WARRANTY, STATUTE, TORT, STRICT LIABILITY, NEGLIGENCE, OR OTHERWISE.**

Banner Engineering Corp. reserves the right to change, modify or improve the design of the product without assuming any obligations or liabilities relating to any product previously manufactured by Banner Engineering Corp. Any misuse, abuse, or improper application or installation of this product or use of the product for personal protection applications when the product is identified as not intended for such purposes will void the product warranty. Any modifications to this product without prior express approval by Banner Engineering Corp will void the product warranties. All specifications published in this document are subject to change; Banner reserves the right to modify product specifications or update documentation at any time. Specifications and product information in English supersede that which is provided in any other language. For the most recent version of any documentation, refer to: www.bannerengineering.com.