

## Datasheet

### Segmented Multi-Color Point-Of-Use Indicator





- Individual color segments can be lit separately or in combination
- For error-proofing and Andon<sup>1</sup> applications
- Provides operator guidance, even for those with limited color recognition ability
- Optional labels for enhanced segment identification
- Can be mounted on flat surface or pipe for elevated use
- PNP or NPN input, depending on model
- 1-color models offer flash functionality



#### WARNING: Not To Be Used for Personnel Protection

Never use this device as a sensing device for personnel **protection**. Doing so could lead to serious injury or death. This device does not include the self-checking redundant circuitry necessary to allow its use in personnel safety applications. A sensor failure or malfunction can cause either an energized or de-energized sensor output condition.

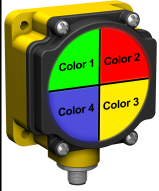
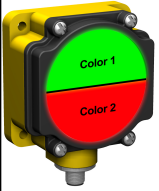
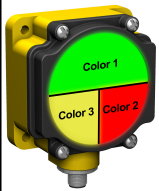
## Models

Model <sup>2</sup>	Colors <sup>3</sup>	Input
 K80L4GRYB1PQ	1: Green 2: Red 3: Yellow 4: Blue	PNP
K80L4GRYB1NQ		NPN
 K80L2HGRXX1PQ	1: Green 2: Red	PNP
K80L2HGRXX1NQ		NPN
 K80L3THGRYX1PQ	1: Green 2: Red 3: Yellow	PNP
K80L3THGRYX1NQ		NPN
 K80L1WXXX1PQ	1: White	PNP
K80L1YXXX1PQ	1: Yellow	
K80L1RXXX1PQ	1: Red	
K80L1GXXX1PQ	1: Green	
K80L1BXXX1PQ	1: Blue	

## Overview

The EZ-LIGHT® K80L Segmented PVC Indicator is a color point-of-use indicator which can be used to send visual messages to an operator or to monitor multiple locations.

Up to four independently selected colors provide the ability to communicate up to four messages, or more if they are used in combination. For example, a green sector could be lit to communicate “all systems OK,” and blue could represent “service needed soon” or “a shoplifter is on the floor.” Green plus red lit together could mean something different from either color lit individually. See wiring diagrams for color selection information.

Indicator colors are fixed in a standardized location, which is helpful for people who have limited color recognition capability.

<sup>1</sup> Andon lights on machines or production lines indicate operation status. They are often located overhead for workers or a supervisor to view them.  
<sup>2</sup> Integral quick disconnect models are listed.  
 • To order the 150 mm (6 in) PVC cable model with a 5-pin M12/Euro-style quick disconnect, replace the suffix “Q” with “QP” in the model number.  
 • To order the 2 m (6.5 ft) PVC cable model, omit the suffix “Q” in the model number.  
 • To order the 150 mm (6 in) PUR cable model with a 5-Pin M12/Euro-style quick disconnect, replace the suffix “Q” with “QPMA” in the model number.  
 • Models with a quick disconnect require a mating cordset.  
<sup>3</sup> Contact Banner Engineering for other colors and color combinations.



The K80L Segmented Indicator mounts easily on a flat surface, but can also be placed on various types of pipe for elevated use. Banner offers stainless steel pipe and other mounting accessories.

## Setup for Alternate Operation

The Program DIP switch is located inside the K80L cover. Remove the four screws to remove the cover.

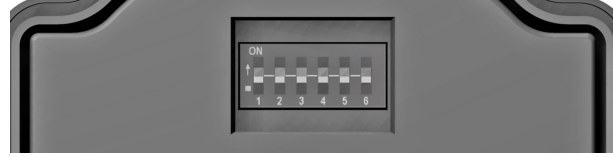

Figure 1. DIP Switches

### Configuration for Flash Function (1-color models only)

DIP Switch Positions						LED Function
SW1	SW2	SW3	SW4	SW5	SW6	
OFF	OFF	OFF	OFF	OFF	OFF	Color 1 ON solid
ON	OFF	OFF	OFF	OFF	OFF	Color 1 Flashes – 50% duty cycle; 2 Hz rate
OFF	ON	OFF	OFF	OFF	OFF	Color 1 Flashes – 50% duty cycle; 1 Hz rate
OFF	OFF	ON	OFF	OFF	OFF	Color 1 Flashes – 50% duty cycle; 0.5 Hz rate
OFF	OFF	OFF	ON	OFF	OFF	Color 1 Flashes – 25% duty cycle; 1 Hz rate
OFF	OFF	OFF	OFF	ON	OFF	Color 1 Flashes – 25% duty cycle; 0.5 Hz rate
OFF	OFF	OFF	OFF	OFF	ON	Color 1 Flashes – 25% duty cycle; 0.25 Hz rate

### Configuration for Demo Mode (2-, 3-, and 4-color models only)

Change the switch 1 position to ON. The individual sectors light depending on the input power, as described at right.

Black wire input	Colors 1 and 2 alternate
Brown wire input	Colors light simultaneously
White wire input	Colors light in rotation (3- and 4-color models only)

## Wiring Diagrams

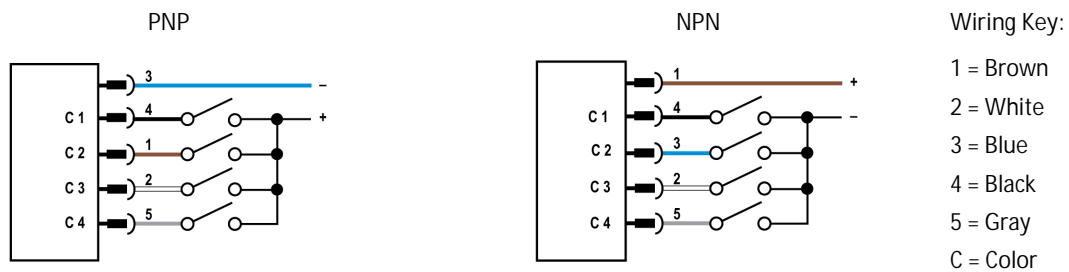

Note: Wiring shown is for 4-color segmented models. Depending on the model and number of segments, pins 5, 3, 2 and 1 may not be used.

## Terminal Block Locations

PNP Internal Terminal Blocks

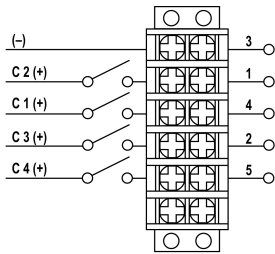

NPN Internal Terminal Blocks

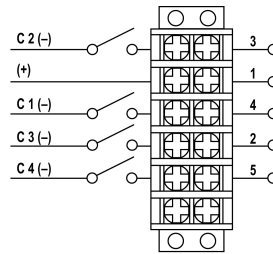

Wiring Key:

- 1 = Brown
- 2 = White
- 3 = Blue
- 4 = Black
- 5 = Gray
- C = Color

## Specifications

### Supply Voltage and Current

- 18 V dc to 30 V dc
- K80L4 models: at 35 mA maximum per LED color, at 90 mA maximum with all LEDs ON
- K80L3 models: at 50 mA maximum with 1 color ON, at 35 mA maximum with color 2 or 3 ON, at 90 mA maximum with all LEDs ON
- K80L2 models: at 50 mA maximum with color 1 or 2 ON, at 90 mA maximum with all LEDs ON
- K80L1 models: at 90 mA maximum

### Supply Protection Circuitry

Protected against reverse polarity and transient voltages

### Construction

Base: ABS/polycarbonate  
Translucent face: acrylic

### Connections

5-pin M12/Euro-style integral QD connector standard; 150 mm (6 in) cabled QD; or terminal-wired, depending on model.

### Vibration and Mechanical Shock

All models meet Mil Std. 202F requirements. Method 201A (vibration: 10 Hz to 60 Hz max., double amplitude 0.06 inch, maximum acceleration 10G). Also meets IEC 947-5-2 requirements: 30G 11 ms duration, half sine wave.

### Indicators

LEDs are independently selected: Green, Red, Yellow, Blue, or White; 1-4 colors, depending on model. For other colors, contact Banner Engineering for availability.

### Input Response Time

Indicator ON: Initial Light – 250 ms maximum, additional lights – 10 ms maximum  
Indicator OFF: 10 ms maximum

### Adjustments

The K80L Segmented features a 6-position Program DIP switch inside the indicator cover. For normal operation, no adjustment should be necessary; these switches should remain all in the down position. For alternate operation (flash functionality for 1-color models, Demo mode for 2-, 3-, and 4-color models), see Setup for Alternate Operation.

### Environmental Rating

IEC IP67, NEMA 6

### Certifications



## Dimensions

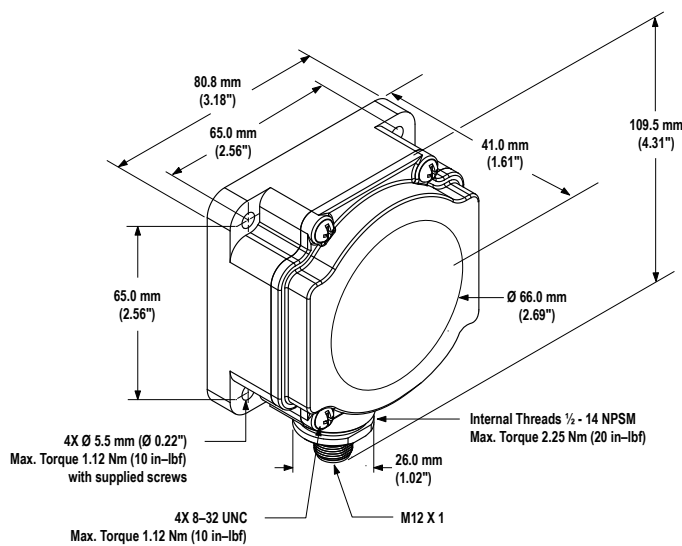

## Accessories

### 5-Pin Euro-Style Cordsets

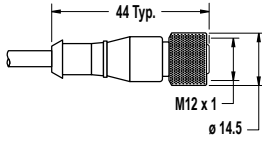
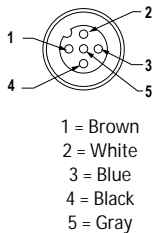
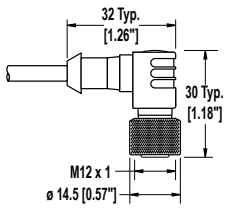
5-Pin Threaded M12/Euro-Style Cordsets—Single Ended				
Model	Length	Style	Dimensions	Pinout (Female)
MQDC1-501.5	0.50 m (1.5 ft)	Straight		
MQDC1-506	1.83 m (6 ft)			
MQDC1-515	4.57 m (15 ft)			
MQDC1-530	9.14 m (30 ft)			
MQDC1-506RA	1.83 m (6 ft)	Right-Angle		
MQDC1-515RA	4.57 m (15 ft)			
MQDC1-530RA	9.14 m (30 ft)			



### Brackets

#### SMBDX80D

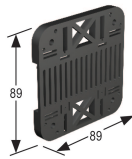
DIN-mount bracket for K80L models, mounts on 35 mm DIN rail  
Hardware included to mount to K80L housing  
Black reinforced thermoplastic



### Elevated Mounting Systems

Model			Features	Components
Polished 304 Stainless Steel	Black Anodized Aluminum	Clear Anodized Aluminum	<ul style="list-style-type: none"> <li>Elevated-use stand-off pipe (½ in. NPSM/DN15)</li> <li>Polished 304 stainless steel, black anodized aluminum, or clear anodized aluminum surface</li> <li>½ in. NPT thread at both ends</li> <li>Compatible with most industrial environments</li> </ul>	
SOP-E12-150SS 150 mm (6 in) long	SOP-E12-150A 150 mm (6 in) long	SOP-E12-150AC 150 mm (6 in) long		
SOP-E12-300SS 300 mm (12 in) long	SOP-E12-300A 300 mm (12 in) long	SOP-E12-300AC 300 mm (12 in) long		
SOP-E12-900SS 900 mm (36 in) long	SOP-E12-900A 900 mm (36 in) long	SOP-E12-900AC 900 mm (36 in) long		
SA-E12M30 - Black Acetal			<ul style="list-style-type: none"> <li>Streamlined black acetal or white UHMW mounting base adapter/cover</li> <li>Connects between ½ in. NPSM/DN15 pipe and 30 mm (1-3/16 in) drilled hole</li> <li>Mounting hardware included</li> </ul>	
SA-E12M30C - White UHMW				

### Accessory Quadrant Labels

Transparent self-adhesive cover labels for printing in a standard laser printer; print your own labels to easily identify each quadrant. Clear protective labels provide additional protection for laser print work in many industrial environments. Six labels per sheet; 5 sheets per package.

Model	Description	Size
SALK-K80L4-0	1-quadrant transparent laser label (includes 30 labels)	8.5 in × 11 in

## Banner Engineering Corp. Limited Warranty

---

Banner Engineering Corp. warrants its products to be free from defects in material and workmanship for one year following the date of shipment. Banner Engineering Corp. will repair or replace, free of charge, any product of its manufacture which, at the time it is returned to the factory, is found to have been defective during the warranty period. This warranty does not cover damage or liability for misuse, abuse, or the improper application or installation of the Banner product.

THIS LIMITED WARRANTY IS EXCLUSIVE AND IN LIEU OF ALL OTHER WARRANTIES WHETHER EXPRESS OR IMPLIED (INCLUDING, WITHOUT LIMITATION, ANY WARRANTY OF MERCHANTABILITY OR FITNESS FOR A PARTICULAR PURPOSE), AND WHETHER ARISING UNDER COURSE OF PERFORMANCE, COURSE OF DEALING OR TRADE USAGE.

This Warranty is exclusive and limited to repair or, at the discretion of Banner Engineering Corp., replacement. IN NO EVENT SHALL BANNER ENGINEERING CORP. BE LIABLE TO BUYER OR ANY OTHER PERSON OR ENTITY FOR ANY EXTRA COSTS, EXPENSES, LOSSES, LOSS OF PROFITS, OR ANY INCIDENTAL, CONSEQUENTIAL OR SPECIAL DAMAGES RESULTING FROM ANY PRODUCT DEFECT OR FROM THE USE OR INABILITY TO USE THE PRODUCT, WHETHER ARISING IN CONTRACT OR WARRANTY, STATUTE, TORT, STRICT LIABILITY, NEGLIGENCE, OR OTHERWISE.

Banner Engineering Corp. reserves the right to change, modify or improve the design of the product without assuming any obligations or liabilities relating to any product previously manufactured by Banner Engineering Corp. Any misuse, abuse, or improper application or installation of this product or use of the product for personal protection applications when the product is identified as not intended for such purposes will void the product warranty. Any modifications to this product without prior express approval by Banner Engineering Corp will void the product warranties. All specifications published in this document are subject to change; Banner reserves the right to modify product specifications or update documentation at any time.

Specifications and product information in English supersede that which is provided in any other language. For the most recent version of any documentation, refer to:  
[www.bannerengineering.com](http://www.bannerengineering.com).