

EZ-LIGHT® K50L Sealed Audible Indicators



Datasheet

DC-Operated Indicators with Steady or Pulsed Sound Indication

To view or download the latest technical information about this product, including specifications, dimensions, accessories, and wiring, see www.bannerengineering.com.



- Rugged, cost-effective, and easy-to-install bright indicators with audible alarm
- Fully sealed and rated at IP67 or IP69K, depending on model
- Compact devices are completely self-contained, no controller needed
- Immune to EMI and RFI interference
- Loud audible alarm with intensity adjustment (IEC IP67 models)
- 12 V dc to 30 V dc operation
- Available in continuous and staccato tones (IP67 models)



WARNING: Not To Be Used for Personnel Protection

Never use this device as a sensing device for personnel **protection**. Doing so could lead to serious injury or death. This device does not include the self-checking redundant circuitry necessary to allow its use in personnel safety applications. A sensor failure or malfunction can cause either an energized or de-energized sensor output condition.

Models

Model	LED Function ¹	Input	Audible Tone†	Connection ²
Fixed Audible Sealed Models				
K50LGXASXPQ	1 Color: Green	PNP	Fixed tone volume	5-pin M12/Euro-style quick disconnect (QD)
K50LGRASXPQ	2 Color: Green, Red			
K50LGRASYPQ	3 Color: Green, Red, Yellow			
K50LGXASXNQ	1 Color: Green	NPN		
K50LGRASXNQ	2 Color: Green, Red			
K50LGRASYNQ	3 Color: Green, Red, Yellow			
Adjustable Loud Audible Sealed Models				
K50LGXALSXPQ	1 Color: Green	PNP	Continuous tone with volume adjustment	5-pin M12/Euro-style quick disconnect (QD)
K50LGRALSXPQ	2 Color: Green, Red			
K50LGRALSYPQ	3 Color: Green, Red, Yellow			
K50LGXALSXNQ	1 Color: Green	NPN		
K50LGRALSXNQ	2 Color: Green, Red			
K50LGRALSYNQ	3 Color: Green, Red, Yellow			
K50LGXALS4XPQ	1 Color: Green	PNP	Staccato tone with volume adjustment	5-pin M12/Euro-style quick disconnect (QD)
K50LGRALS4XPQ	2 Color: Green, Red			
K50LGRALS4YPQ	3 Color: Green, Red, Yellow			
K50LGXALS4XNQ	1 Color: Green	NPN		
K50LGRALS4XNQ	2 Color: Green, Red			
K50LGRALS4YNQ	3 Color: Green, Red, Yellow			

¹ Contact Banner Engineering for other colors and color combinations.

² Integral 5-pin M12/Euro-style quick disconnect models are listed.

- To order the 150 mm (6 in) PVC cable model, replace the suffix "Q" with "QP" in the model number. For example, K50LGXASXPQP.
- To order the 2 m (6.5 ft) PVC cable model, omit the suffix "Q" in the model number. For example, K50LGXASXP.
- Models with a quick disconnect require a mating cordset.



Installation in Very Wet Environments

For best sound quality and volume when mounting an IP67 audible indicator model in an extremely wet environment, consider the mounting orientation. Mount the indicator horizontally or facing downward to allow water to drain easily. Upright mounting will allow water to collect in the alarm cavity, which will muffle the sound.

Wiring Diagrams

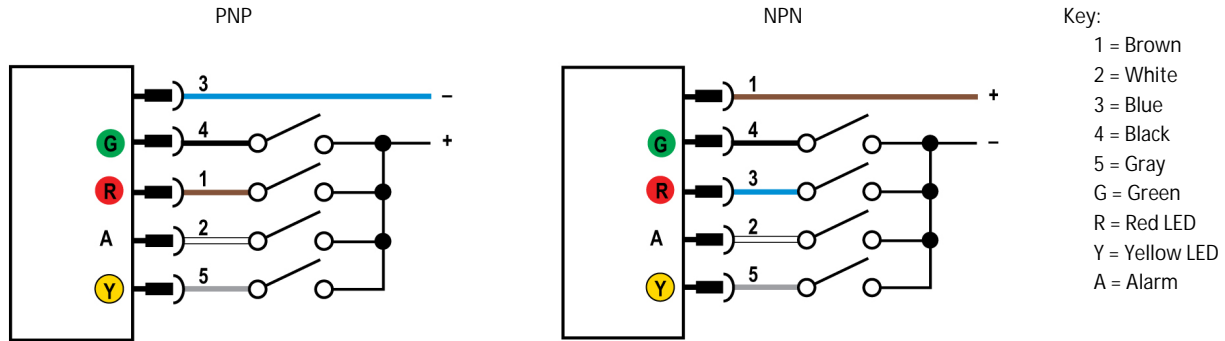

Note: When fewer than three LED colors are used, the corresponding wires are unused.

Specifications

Supply Voltage and Current

12 V dc to 30 V dc
65 mA at 12 V dc; 35 mA at 30 V dc maximum current per LED
Audible: 35 mA maximum current

Supply Protection Circuitry

Protected against reverse polarity and transient voltages

Input Response Time

Indicator ON/OFF: 1 ms maximum
Audible ON/OFF: 10 ms maximum

Audible Alarm

IP67 Models: 2.9 kHz ± 250 Hz oscillation frequency; max. intensity 94 db at 1 m (3.3 ft) (typical)
IP69K Models: 2.9 kHz ± 250 Hz oscillation frequency; max. intensity 65 db at 1 m (3.3) (typical)

Vibration and Mechanical Shock

All models meet Mil Std. 202F requirements. Method 201A (vibration: 10 Hz to 60 Hz max., double amplitude 0.06 inch, maximum acceleration 10G). Also meets IEC 947-5-2 requirements: 30G 11 ms duration, half sine wave.

Environmental Rating

Fixed Audible Sealed Models: IEC IP67/IP69K per DIN 40050-9
Adjustable Loud Audible Sealed Models: IEC IP67
NEMA/UL Type 4X, 13

Operating Conditions

-20 °C to +50 °C (-4 °F to +122 °F)
95% maximum relative humidity (non-condensing)

Certifications



Audible Adjustment

Rotate the front cover until the desired intensity is achieved (IEC IP67 models only)

Connections

Integral 5-pin M12/Euro-style quick disconnect or 2 m (6.5 ft) integral cable, depending on model

Construction

Fixed Audible Sealed Models: Polycarbonate housing and audible alarm
Adjustable Loud Audible Sealed Models: Polycarbonate housing and PPO audible alarm

Required Overcurrent Protection



WARNING: Electrical connections must be made by qualified personnel in accordance with local and national electrical codes and regulations.

Overcurrent protection is required to be provided by end product application per the supplied table.

Overcurrent protection may be provided with external fusing or via Current Limiting, Class 2 Power Supply.

Supply wiring leads < 24 AWG shall not be spliced.

For additional product support, go to www.bannerengineering.com.

Supply Wiring (AWG)	Required Overcurrent Protection (Amps)
20	5.0
22	3.0
24	2.0
26	1.0
28	0.8
30	0.5

Dimensions

Cabled Dimensions

QD Dimensions

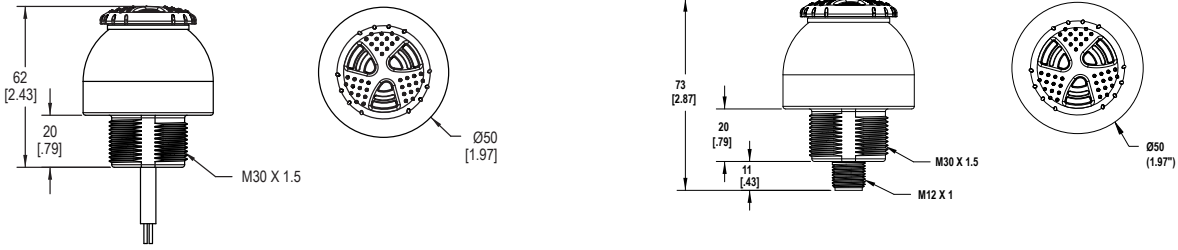

Accessories

5-Pin Euro-Style Cordsets

5-Pin Threaded M12/Euro-Style Cordsets—Single Ended				
Model	Length	Style	Dimensions	Pinout (Female)
MODC1-501.5	0.50 m (1.5 ft)	Straight		<p>1 = Brown 2 = White 3 = Blue 4 = Black 5 = Gray</p>
MODC1-506	1.83 m (6 ft)			
MODC1-515	4.57 m (15 ft)			
MODC1-530	9.14 m (30 ft)			
MODC1-506RA	1.83 m (6 ft)	Right-Angle		
MODC1-515RA	4.57 m (15 ft)			
MODC1-530RA	9.14 m (30 ft)			

Mounting Brackets

SMB30A

- Right-angle bracket with curved slot for versatile orientation
- Clearance for M6 (¼ in) hardware
- Mounting hole for 30 mm sensor
- 12-ga. stainless steel

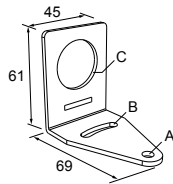

Hole center spacing: A to B=40
Hole size: A=ø 6.3, B= 27.1 x 6.3, C=ø 30.5

SMB30FA

- Swivel bracket with tilt and pan movement for precise adjustment
- Mounting hole for 30 mm sensor
- 12-ga. 304 stainless steel
- Easy sensor mounting to extrude rail T-slot
- Metric and inch size bolt available

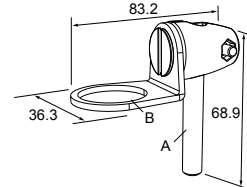

Bolt thread: SMB30FA, A= 3/8 - 16 x 2 in; SMB30FAM10, A= M10 - 1.5 x 50
Hole size: B= ø 30.1

SMB30MM

- 12-ga. stainless steel bracket with curved mounting slots for versatile orientation
- Clearance for M6 (¼ in) hardware
- Mounting hole for 30 mm sensor

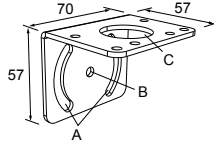

Hole center spacing: A = 51, A to B = 25.4
Hole size: A = 42.6 x 7, B = ϕ 6.4, C = ϕ 30.1

SMB30SC

- Swivel bracket with 30 mm mounting hole for sensor
- Black reinforced thermoplastic polyester
- Stainless steel mounting and swivel locking hardware included

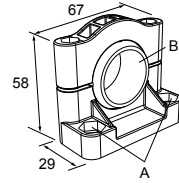

Hole center spacing: A= ϕ 50.8
Hole size: A= ϕ 7.0, B= ϕ 30.0

SMB30SK

- Flat-mount swivel bracket with extended range of motion
- Black reinforced thermoplastic polyester and 316 stainless steel
- Stainless steel swivel locking hardware included

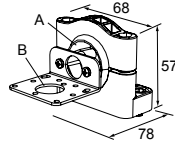

Hole center spacing: A = 50.8
Hole size: A = ϕ 7, B = ϕ 18

Elevated Mount System

Model	Features		Components
SA-M30E12 - Black Acetal	<ul style="list-style-type: none"> • Streamlined black acetal stand-off pipe adapter/cover • Connects between 30 mm light base and ½ in. NPSM/DN15 pipe • Mounting hardware included 		
Polished 304 Stainless Steel	Black Anodized Aluminum	Clear Anodized Aluminum	<ul style="list-style-type: none"> • Elevated-use stand-off pipe (½ in. NPSM/DN15) • Polished 304 stainless steel, black anodized aluminum, or clear anodized aluminum surface • ½ in. NPT thread at both ends • Compatible with most industrial environments
SOP-E12-150SS 150 mm (6 in) long	SOP-E12-150A 150 mm (6 in) long	SOP-E12-150AC 150 mm (6 in) long	
SOP-E12-300SS 300 mm (12 in) long	SOP-E12-300A 300 mm (12 in) long	SOP-E12-300AC 300 mm (12 in) long	
SOP-E12-900SS 900 mm (36 in) long	SOP-E12-900A 900 mm (36 in) long	SOP-E12-900AC 900 mm (36 in) long	
SA-E12M30 - Black Acetal	<ul style="list-style-type: none"> • Streamlined black acetal mounting base adapter/cover • Connects between ½ in. NPSM/DN15 pipe and 30 mm (1-3/16 in) drilled hole • Mounting hardware included 		

Banner Engineering Corp. Limited Warranty

Banner Engineering Corp. warrants its products to be free from defects in material and workmanship for one year following the date of shipment. Banner Engineering Corp. will repair or replace, free of charge, any product of its manufacture which, at the time it is returned to the factory, is found to have been defective during the warranty period. This warranty does not cover damage or liability for misuse, abuse, or the improper application or installation of the Banner product.

THIS LIMITED WARRANTY IS EXCLUSIVE AND IN LIEU OF ALL OTHER WARRANTIES WHETHER EXPRESS OR IMPLIED (INCLUDING, WITHOUT LIMITATION, ANY WARRANTY OF MERCHANTABILITY OR FITNESS FOR A PARTICULAR PURPOSE), AND WHETHER ARISING UNDER COURSE OF PERFORMANCE, COURSE OF DEALING OR TRADE USAGE.

This Warranty is exclusive and limited to repair or, at the discretion of Banner Engineering Corp., replacement. IN NO EVENT SHALL BANNER ENGINEERING CORP. BE LIABLE TO BUYER OR ANY OTHER PERSON OR ENTITY FOR ANY EXTRA COSTS, EXPENSES, LOSSES, LOSS OF PROFITS, OR ANY INCIDENTAL, CONSEQUENTIAL OR SPECIAL DAMAGES RESULTING FROM ANY PRODUCT DEFECT OR FROM THE USE OR INABILITY TO USE THE PRODUCT, WHETHER ARISING IN CONTRACT OR WARRANTY, STATUTE, TORT, STRICT LIABILITY, NEGLIGENCE, OR OTHERWISE.

Banner Engineering Corp. reserves the right to change, modify or improve the design of the product without assuming any obligations or liabilities relating to any product previously manufactured by Banner Engineering Corp. Any misuse, abuse, or improper application or installation of this product or use of the product for personal protection applications when the product is identified as not intended for such purposes will void the product warranty. Any modifications to this product without prior express approval by Banner Engineering Corp will void the product warranties. All specifications published in this document are subject to change. Banner reserves the right to modify product specifications or update documentation at any time. Specifications and product information in English supersede that which is provided in any other language. For the most recent version of any documentation, refer to: www.bannerengineering.com.