

Datasheet

AC-operated, multi-color, general-purpose indicators

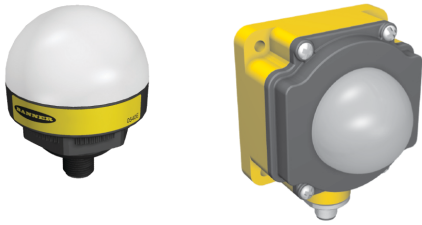

- Rugged, cost-effective, and easy-to-install indicators available in K50 or K80 housing style
- Illumination provides easy-to-see operator guidance and equipment status indication
- Compact devices are completely self-contained, no controller needed
- 85 V ac to 130 V ac operation
- Displays 3 colors
- Immune to ambient light, EMI, and RFI interference



Contact Banner Engineering for more information.

Models

Model	Construction	Connection ¹	LED Function ²	Inputs
K50LGRYA120Q	50 mm dome/ 30 mm mount polycarbonate	5-pin Micro QD	3 Color: Green, Red, Yellow	85 to 130 V ac
K80LGRYA120Q	50 mm dome/Flat or DIN-mount polycarbonate			

Wiring

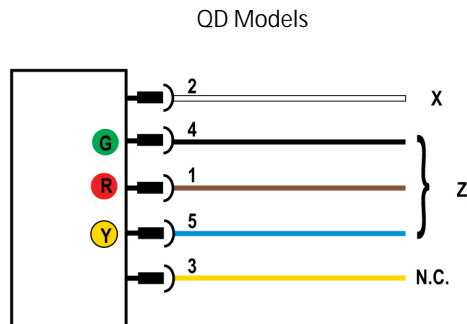
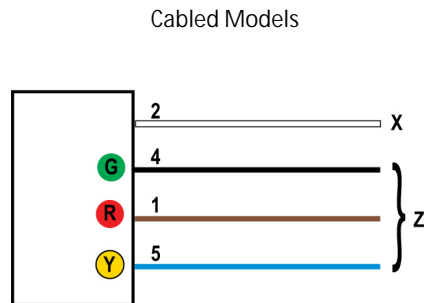

Key:

- 1 = Brown
- 2 = White
- 3 = Yellow
- 4 = Black
- 5 = Blue
- G = Green
- R = Red
- Y = Yellow
- X = V ac Neutral
- Z = Input 85 to 130V ac
- N.C. = Not Used

¹ Integral QD models are listed.

- For 150 mm PVC pigtail with QD, replace Q with QP in model number (example, K50LGRYA120QP).
- For 2 m (6.5 ft) PVC cable, omit suffix Q from model number (example, K50LGRYA120).
- A model with a QD requires a mating cable (see [Cordsets](#) on page 3)

² Contact Banner Engineering for other colors and color combinations.



Specifications

Supply Voltage and Current

85 to 130 V ac at 15 mA maximum

Supply Protection Circuitry

Protected against transient voltages

Indicators

LEDs are independently selected: Green, Red, or Yellow.

Input Response Time

Indicator ON/OFF: 1 ms max.

Environmental Rating

Rated IEC IP67. K50L models fully encapsulated; K80L has encapsulated electronics only. K50L QD models meet IP69K, per DIN 40050-9; cabled models also meet IP69K if the cable and cable entrance are protected from high-pressure spray.

Certifications

K50L and K80L models:



K50L models only:



Connections

5-pin Micro-style integral QD (Q), 150 mm (6 in) pigtail QD (QP), or 2 m (6.5 ft) integral cable, depending on model
K80L models: terminal-wired models available for use with bulk cable; compression fitting optional. Contact Banner Engineering for cable information.

Operating Conditions

-40 °C to +50 °C (-40 °F to +122 °F)

90% at +55 °C maximum relative humidity (non-condensing)

Required Overcurrent Protection



WARNING: Electrical connections must be made by qualified personnel in accordance with local and national electrical codes and regulations.

Overcurrent protection is required to be provided by end product application per the supplied table.

Overcurrent protection may be provided with external fusing or via Current Limiting, Class 2 Power Supply.

Supply wiring leads < 24 AWG shall not be spliced.

For additional product support, go to www.bannerengineering.com.

Supply Wiring (AWG)	Required Overcurrent Protection (Amps)
20	5.0
22	3.0
24	2.0
26	1.0
28	0.8
30	0.5

Dimensions

K50L

K80L

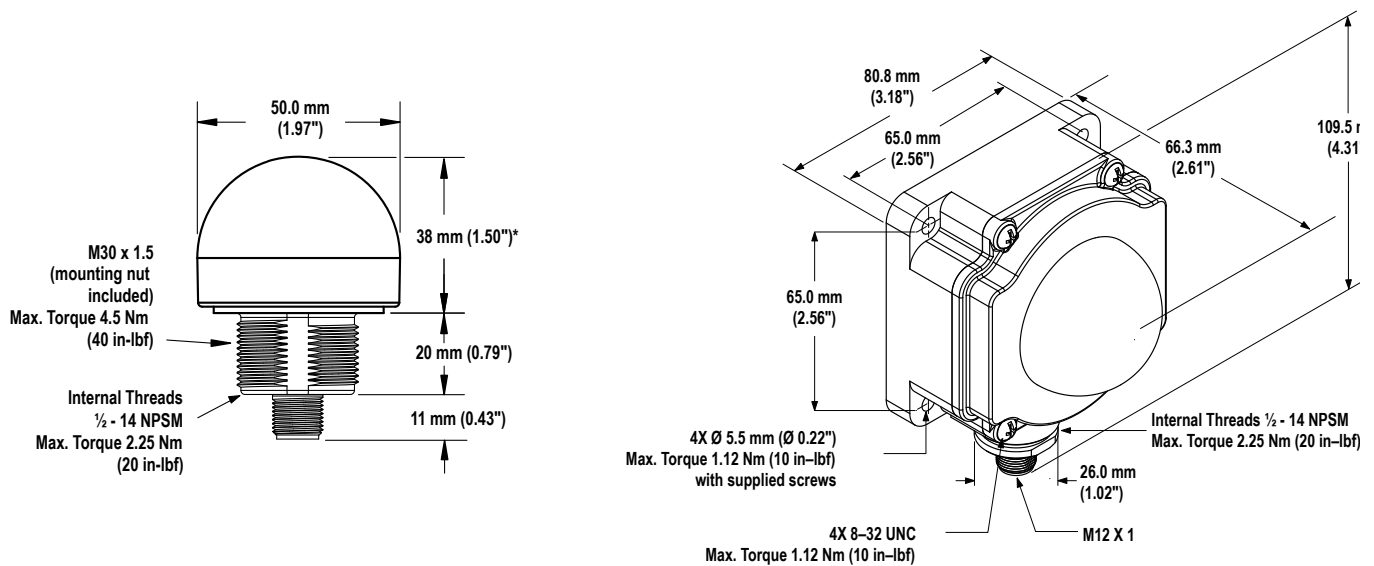

Accessories

Cordsets

5-Pin Micro-Style Cordsets—with Shield				
Model	Length	Style	Dimensions	Pinout (Female)
MQVR3S-506	1.83 m (6 ft)	Straight		<p>1 = Brown 2 = White 3 = Yellow 4 = Black 5 = Blue</p>
MQVR3S-515	4.57 m (15 ft)			
MQVR3S-530	9.14 m (30 ft)			
MQVR3S-506RA	1.83 m (6 ft)	Right Angle		
MQVR3S-515RA	4.57 m (15 ft)			
MQVR3S-530RA	9.14 m (30 ft)			

Brackets

All measurements are listed in millimeters, unless noted otherwise.

SMB30A

- Right-angle bracket with curved slot for versatile orientation
- Clearance for M6 (¼ in) hardware
- Mounting hole for 30 mm sensor
- 12-ga. stainless steel

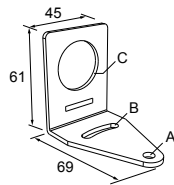

Hole center spacing: A to B=40
Hole size: A=ø 6.3, B= 27.1 x 6.3, C=ø 30.5

SMB30SC

- Swivel bracket with 30 mm mounting hole for sensor
- Black reinforced thermoplastic polyester
- Stainless steel mounting and swivel locking hardware included

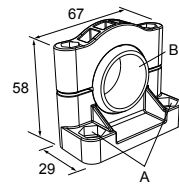

Hole center spacing: A=ø 50.8
Hole size: A=ø 7.0, B=ø 30.0

SMB30FA

- Swivel bracket with tilt and pan movement for precise adjustment
- Mounting hole for 30 mm sensor
- 12-ga. 304 stainless steel
- Easy sensor mounting to extrude rail T-slot
- Metric and inch size bolt available

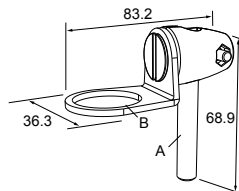

Bolt thread: SMB30FA, A= 3/8 - 16 x 2 in; SMB30FAM10, A= M10 - 1.5 x 50
Hole size: B= ø 30.1

SMBAMS30P

- Flat SMBAMS series bracket
- 30 mm hole for mounting sensors
- Articulation slots for 90°+ rotation
- 12-ga. 300 series stainless steel

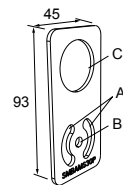

Hole center spacing: A=26.0, A to B=13.0
Hole size: A=26.8 x 7.0, B=ø 6.5, C=ø 31.0

SMB30MM

- 12-ga. stainless steel bracket with curved mounting slots for versatile orientation
- Clearance for M6 (¼ in) hardware
- Mounting hole for 30 mm sensor

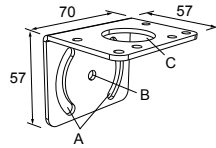

Hole center spacing: A = 51, A to B = 25.4
Hole size: A = 42.6 x 7, B = \varnothing 6.4, C = \varnothing 30.1

SMBAMS30RA

- Right-angle SMBAMS series bracket
- 30 mm hole for mounting sensors
- Articulation slots for 90°+ rotation
- 12-ga. (2.6 mm) cold-rolled steel

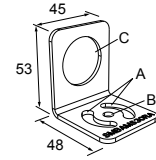

Hole center spacing: A=26.0, A to B=13.0
Hole size: A=26.8 x 7.0, B= \varnothing 6.5, C= \varnothing 31.0

For K80L**SMBDX80DIN**

Black reinforced thermoplastic
Bracket for mounting on a 35 mm DIN rail

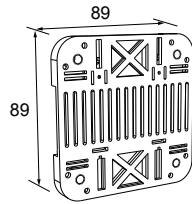

Banner Engineering Corp. Limited Warranty

Banner Engineering Corp. warrants its products to be free from defects in material and workmanship for one year following the date of shipment. Banner Engineering Corp. will repair or replace, free of charge, any product of its manufacture which, at the time it is returned to the factory, is found to have been defective during the warranty period. This warranty does not cover damage or liability for misuse, abuse, or the improper application or installation of the Banner product.

THIS LIMITED WARRANTY IS EXCLUSIVE AND IN LIEU OF ALL OTHER WARRANTIES WHETHER EXPRESS OR IMPLIED (INCLUDING, WITHOUT LIMITATION, ANY WARRANTY OF MERCHANTABILITY OR FITNESS FOR A PARTICULAR PURPOSE), AND WHETHER ARISING UNDER COURSE OF PERFORMANCE, COURSE OF DEALING OR TRADE USAGE.

This Warranty is exclusive and limited to repair or, at the discretion of Banner Engineering Corp., replacement. IN NO EVENT SHALL BANNER ENGINEERING CORP. BE LIABLE TO BUYER OR ANY OTHER PERSON OR ENTITY FOR ANY EXTRA COSTS, EXPENSES, LOSSES, LOSS OF PROFITS, OR ANY INCIDENTAL, CONSEQUENTIAL OR SPECIAL DAMAGES RESULTING FROM ANY PRODUCT DEFECT OR FROM THE USE OR INABILITY TO USE THE PRODUCT, WHETHER ARISING IN CONTRACT OR WARRANTY, STATUTE, TORT, STRICT LIABILITY, NEGLIGENCE, OR OTHERWISE.

Banner Engineering Corp. reserves the right to change, modify or improve the design of the product without assuming any obligations or liabilities relating to any product previously manufactured by Banner Engineering Corp. Any misuse, abuse, or improper application or installation of this product or use of the product for personal protection applications when the product is identified as not intended for such purposes will void the product warranty. Any modifications to this product without prior express approval by Banner Engineering Corp will void the product warranties. All specifications published in this document are subject to change; Banner reserves the right to modify product specifications or update documentation at any time. Specifications and product information in English supersede that which is provided in any other language. For the most recent version of any documentation, refer to: www.bannerengineering.com.