

Q4X Stainless Steel Laser Sensor for Clear Object Detection



Quick Start Guide

Class 1 laser CMOS sensor with a discrete (PNP or NPN) output. Patent pending.

This guide is designed to help you set up and install the Q4X Sensor. For complete information on programming, performance, troubleshooting, dimensions, and accessories, please refer to the Instruction Manual at www.bannerengineering.com. Search for p/n 181483 to view the Instruction Manual. Use of this document assumes familiarity with pertinent industry standards and practices.

For illustration purposes, the threaded barrel model Q4X images are used throughout this document.



WARNING: Not To Be Used for Personnel Protection

Never use this device as a sensing device for personnel protection. Doing so could lead to serious injury or death. This device does not include the self-checking redundant circuitry necessary to allow its use in personnel safety applications. A sensor failure or malfunction can cause either an energized or de-energized sensor output condition.

Features

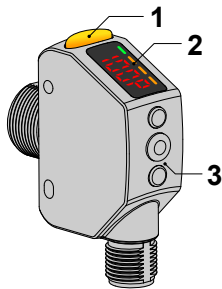

Figure 1. Sensor Features—Threaded Barrel Models

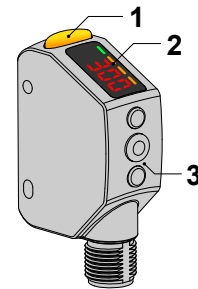

Figure 2. Sensor Features—Flush Mount Models

1. Output Indicator (Amber)
2. Display
3. Buttons

Display and Indicators

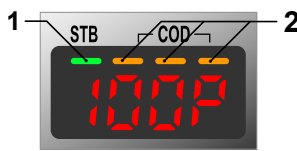

Figure 3. Display in Run Mode

The display is a 4-digit, 7-segment LED. The main screen is the Run Mode screen, which shows the percentage matched to the taught reference surface. A display value of 9999P indicates the sensor has not been taught.

1. Stability Indicator (STB = Green)
2. Active TEACH Indicators
 - COD = Intensity and distance windows for clear object detection

Output Indicator

- On—Outputs conducting (closed)
- Off—Outputs not conducting (open)

Active TEACH Indicators (COD)

- COD all on = Intensity and distance windows for clear object detection enabled

Stability Indicator (STB)

- On—Stable signal within the specified sensing range
- Flashing—Marginal signal, the target is outside the limits of the specified sensing range, or a multiple peak condition exists
- Off—No target detected within the specified sensing range

Buttons

Use the sensor buttons (SELECT)(TEACH), (+)(LO/DO), and (-)(MODE) to program the sensor.



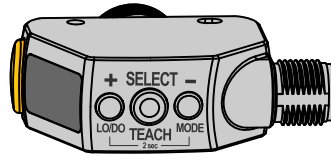

(SELECT) (TEACH)

- Press to select menu items in Setup mode
- Press and hold for longer than 2 seconds to start the Clear Object Detection TEACH mode

(+) (LO/DO)

- Press to navigate the sensor menu in Setup mode
- Press to change setting values; press and hold to increase numeric values
- Press and hold for longer than 2 seconds to switch between light operate (LO) and dark operate (DO)

(-) (MODE)

- Press to navigate the sensor menu in Setup mode
- Press to change setting values; press and hold to decrease numeric values
- Press and hold for longer than 2 seconds to enter Setup mode



NOTE: When navigating the menu, the menu items loop.

Laser Description and Safety Information



CAUTION: Use of controls or adjustments or performance of procedures other than those specified herein may result in hazardous radiation exposure. Do not attempt to disassemble this sensor for repair. A defective unit must be returned to the manufacturer.

Class 1 Lasers

Class 1 lasers are lasers that are safe under reasonably foreseeable conditions of operation, including the use of optical instruments for intrabeam viewing.



Laser wavelength: 655 nm

Output: < 0.20 mW

Pulse Duration: 7 μ s to 2 ms

Installation

Install the Safety Label

The safety label must be installed on Q4X sensors that are used in the United States.



NOTE: Position the label on the cable in a location that has minimal chemical exposure.

1. Remove the protective cover from the adhesive on the label.
2. Wrap the label around the Q4X cable, as shown.
3. Press the two halves of the label together.

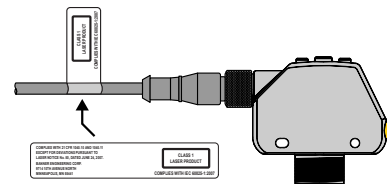

Figure 4. Safety Label Installation

Sensor Orientation and Mounting Considerations for Transparent and Clear Object Detection

Optimize the reliable detection of transparent and clear objects by applying these principals when selecting your reference surface, positioning your sensor relative to the reference surface, and presenting your target. The robust detection capabilities of the Q4X will allow successful detection even under non-ideal conditions in many cases.

1. Select a reference surface with these characteristics where possible:
 - Matte or diffuse surface finish
 - Fixed surface with no vibration
 - Dry surface with no build-up of oil, water, or dust
2. Position the reference surface between 50 and 300 mm (threaded barrel models) or 60 mm and 310 mm (flush mount models).
3. Position the target to be detected as close to the sensor as possible, and as far away from the reference surface as possible.
4. Angle the sensing beam relative to the target and relative to the reference surface 10 degrees or more.

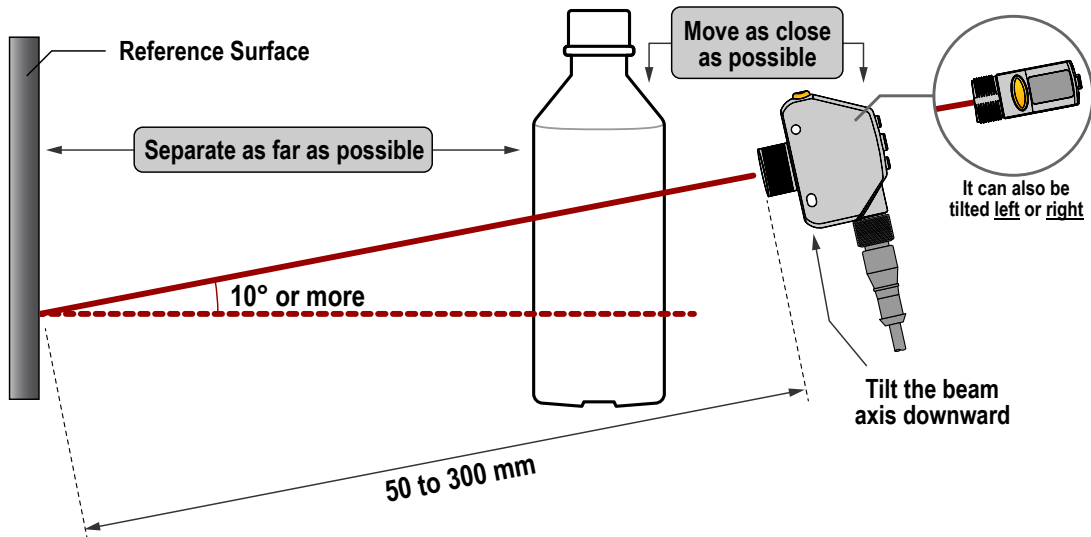

Figure 5. Mounting considerations

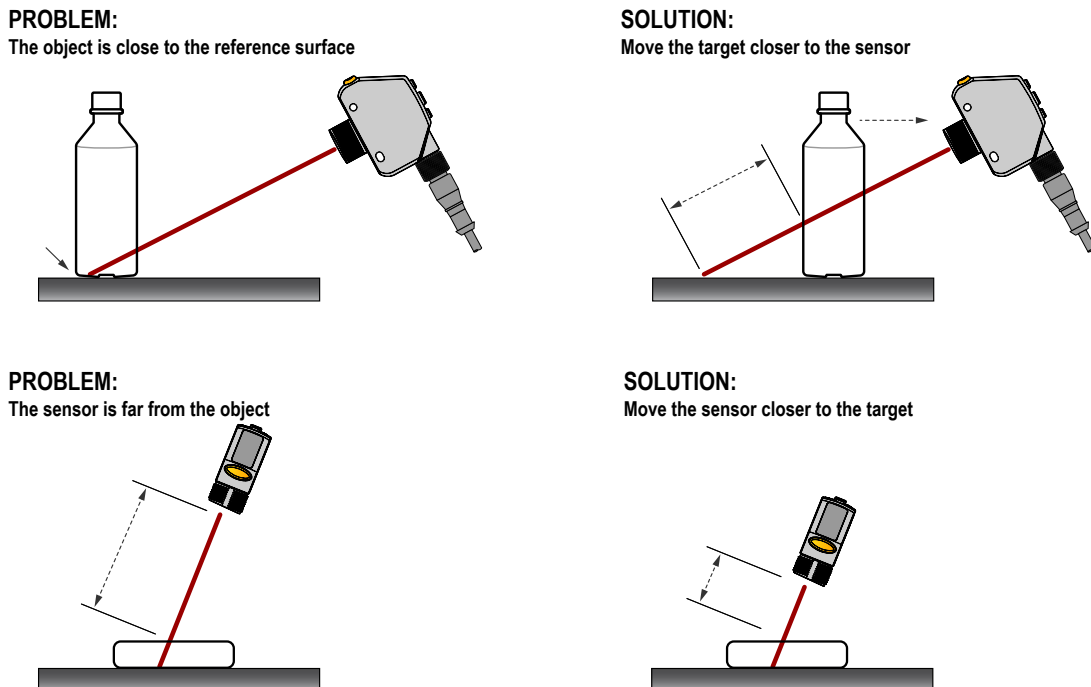
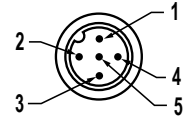
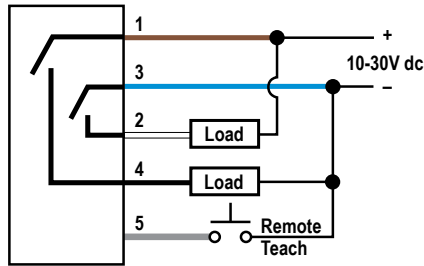

Figure 6. Common problems and solutions for detecting clear objects

Mount the Sensor

1. If a bracket is needed, mount the sensor onto the bracket.
2. Mount the sensor (or the sensor and the bracket) to the machine or equipment at the desired location. Do not tighten the mounting screws at this time.
3. Check the sensor alignment.
4. Tighten the mounting screws to secure the sensor (or the sensor and the bracket) in the aligned position.

Wiring Diagram—Threaded Barrel Models



Key

- 1 = Brown
- 2 = White
- 3 = Blue
- 4 = Black
- 5 = Gray



NOTE: Open lead wires must be connected to a terminal block.



NOTE: The input wire function is user-selectable; see the Instruction Manual for details. The default for the input wire function is off (disabled).

Wiring Diagram—Flush Mount Models

NPN Models

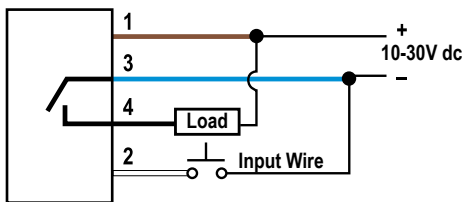

PNP Models

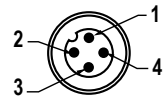
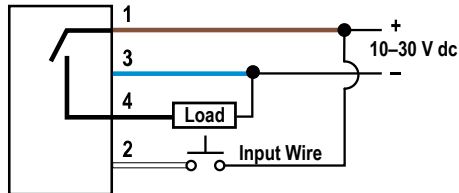

Key

- 1 = Brown
- 2 = White
- 3 = Blue
- 4 = Black



NOTE: Open lead wires must be connected to a terminal block.



NOTE: The input wire function is user-selectable; see the Instruction Manual for details. The default for the input wire function is off (disabled).

Cleaning and Maintenance

Handle the sensor with care during installation and operation. Sensor windows soiled by fingerprints, dust, water, oil, etc. may create stray light that may degrade the peak performance of the sensor. Blow the window clear using filtered, compressed air, then clean as necessary using water and a lint-free cloth.

Sensor Programming

Program the sensor using the buttons on the sensor or the remote input (limited programming options).

In addition to programming the sensor, use the remote input to disable the buttons for security, preventing unauthorized or accidental programming changes. See the Instruction Manual, p/n 181483 for more information.

Setup Mode

Access Setup mode and the sensor menu from Run mode by pressing and holding MODE for longer than 2 seconds. Use **+** and **-** to navigate through the menu. Press SELECT to select a menu option and access the submenus. Use **+** and **-** to navigate through the submenus. Press SELECT to select a submenu option and return to the top menu, or press and hold SELECT for longer than 2 seconds to select a submenu option and return immediately to Run mode.

To exit Setup mode and return to Run mode, navigate to **End** and press SELECT.

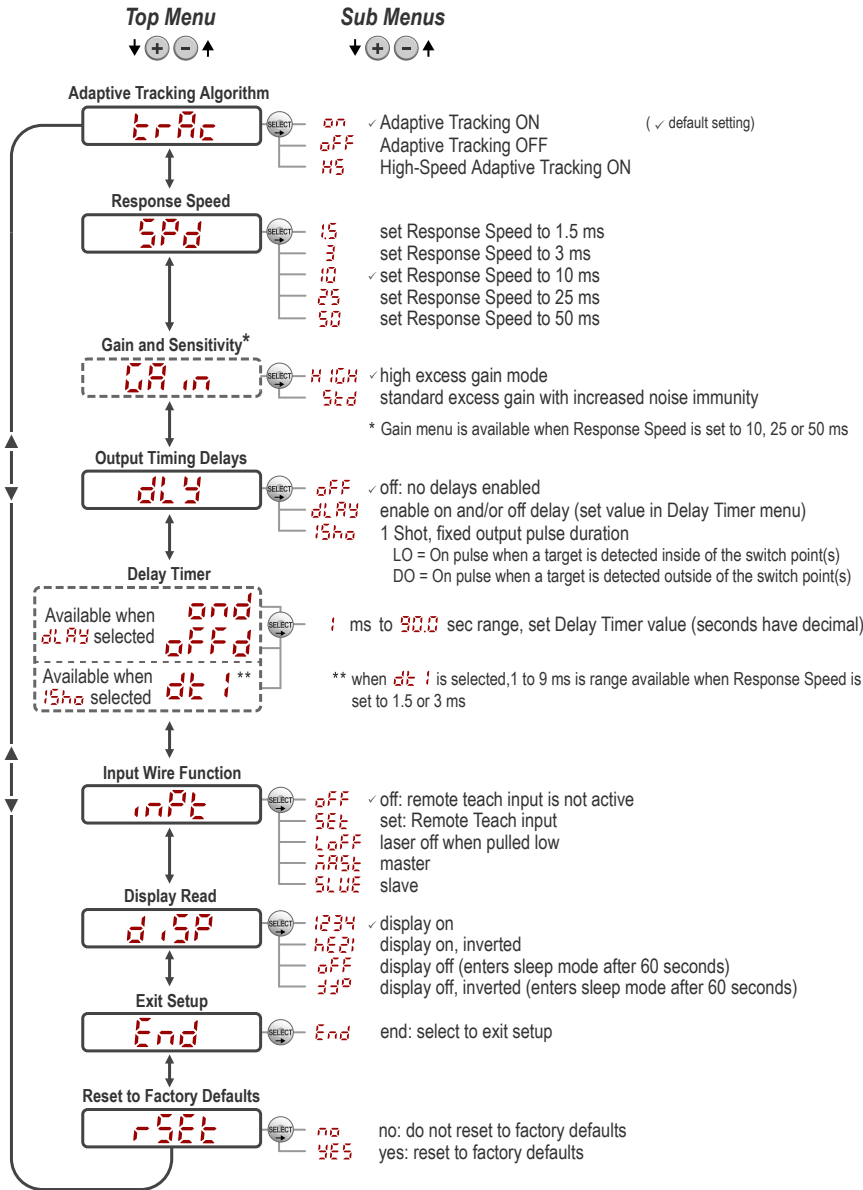

Figure 7. Sensor Menu Map—Channel 1

Basic TEACH Instructions



Use the following instructions to teach the Q4X sensor.





1. Align the sensor to a stable reference surface.
2. Rigidly mount the sensor in this alignment.
3. Press and hold TEACH for longer than 2 seconds to start the TEACH mode.
4. Press TEACH to teach the reference surface. The reference surface is taught, the currently selected switch point value is displayed, and the sensor returns to run mode.



The Q4X sensor records the distance to the reference surface and the amount of laser light returned by the reference surface. The output is switched when an object passing between the sensor and the reference surface changes the perceived distance or amount of returned light. The Q4X is able to detect the very small changes caused by transparent and clear objects. Typical reference surfaces are metal machine frame, conveyor side rail, or mounted plastic targets. Please contact Banner Engineering if you require assistance setting up a stable reference surface in your application.

The Q4X sensor can be taught non-ideal reference surfaces, such as surfaces outside of the sensor range or very dark surfaces. Teaching non-ideal reference surfaces may enable applications other than transparent or clear object detection, but best results for transparent or clear object detection require a stable reference surface as described above in [Sensor Orientation and Mounting Considerations for Transparent and Clear Object Detection](#) on page 3.

Manual Adjustments

Manually adjust the sensor switch point using the  and  buttons.

1. From Run mode, press either  or  one time. The current switch point value flashes slowly.
2. Press  to move the switch point up or  to move the switch point down. After 1 second of inactivity, the new switch point value flashes rapidly, the new setting is accepted, and the sensor returns to Run mode.

After the TEACH process is completed, the taught reference point, a combination of the measured distance and returned signal intensity from the reference target, is recorded by the sensor. Use the push buttons to manually adjust the switch point. Manual adjustment changes the sensitivity of the thresholds around the taught reference point but does not move the taught reference point. Press  to increase the sensitivity and press  to decrease the sensitivity. After re-positioning the sensor or changing the reference target, re-teach the sensor.

The display shows the current match percentage relative to the taught reference point. The switch point defines the sensitivity; the output switches when the current match percentage crosses the switch point.

Your specific application may require some adjustment of the switch point, but these values are recommended starting switch points for common applications.

Switch point (%)	Typical Applications
75 (default)	Default, recommended for PET bottles and Trays
88	Recommended for thin films
50	Recommended for tinted brown, tinted green, or water-filled containers

Light Operate/Dark Operate

The default output configuration is light operate. To switch between light operate and dark operate, use the following instructions:

1. Press and hold LO/DO for longer than 2 seconds. The current selection displays.
2. Press LO/DO again. The new selection flashes slowly.
3. Press SELECT to change the output configuration and return to Run mode.



NOTE: If neither SELECT nor LO/DO are pressed after step 2, the new selection flashes slowly for a few seconds, then flashes quickly and the sensor automatically changes the output configuration and returns to Run mode.

Locking and Unlocking the Sensor Buttons

Use the lock and unlock feature to prevent unauthorized or accidental programming changes. Three settings are available:

- **uLoc** —The sensor is unlocked and all settings can be modified (default).
- **Loc** — The sensor is locked and no changes can be made.
- **ULoc** —The switch point value can be changed by teaching or manual adjustment, but no sensor settings can be changed through the menu.

When in **Loc** mode, **Loc** displays when the (SELECT)(TEACH) button is pressed. The switch point displays when (+)(LO/DO) or (-)(MODE) are pressed, but **Loc** displays if the buttons are pressed and held.

When in **OLoc** mode, **Lac** displays when (+) (LO/DO) or (-) (MODE) are pressed and held. To access the manual adjust options, briefly press and release (+) (LO/DO) or (-) (MODE). To enter TEACH mode, press the (SELECT) (TEACH) button and hold for longer than 2 seconds.

To enter **Lac** mode, hold **+** and press **-** four times. To enter **OLoc** mode, hold **+** and press **-** seven times. Holding **+** and pressing **-** four times unlocks the sensor from either lock mode and the sensor displays **wLoc**.

Specifications

Sensing Beam

Visible red Class 1 laser, 655 nm

Supply Voltage (Vcc)

10 to 30 V dc

Power and Current Consumption, exclusive of load
< 675 mW

Sensing Range

25 mm to 300 mm (0.98 in to 11.81 in)

Output Configuration

Bipolar (1 PNP and 1 NPN) output

Output Rating

100 mA total maximum (protected against continuous overload and short circuit)

Off-state leakage current: < 5 µA at 30 V dc

PNP On-state saturation voltage: < 1.5 V dc at 100 mA load

NPN On-state saturation voltage: < 1.0 V dc at 100 mA load

Remote Input

Allowable Input Voltage Range: 0 to Vcc

Active Low (internal weak pullup—sinking current): Low State < 2.0 V at 1 mA max.

Supply Protection Circuitry

Protected against reverse polarity and transient overvoltages

Response Speed

User selectable:

- **15** —1.5 milliseconds
- **3** —3 milliseconds
- **10** —10 milliseconds
- **25** —25 milliseconds
- **50** —50 milliseconds

Beam Spot Size

Table 1: Beam Spot Size—300 mm Models

Distance (mm)		Size (Horizontal x Vertical)
Threaded Barrel Models	Flush Mount Models	
25	35	2.6 mm x 1.0 mm
150	160	2.3 mm x 0.9 mm
300	310	2.0 mm x 0.8 mm

Excess Gain—Flush Mount Models

Table 2: **HIGH** Excess Gain (**Std** Excess Gain¹)

Response Speed (ms)	Excess Gain—90% White Card	
	at 25 mm	at 300 mm
1.5	200	20
3	200	20
10	1000 (500)	100 (50)
25	2500 (1000)	250 (100)
50	5000 (2500)	500 (250)

Excess Gain

Table 3: **HIGH** Excess Gain (**Std** Excess Gain²)

Response Speed (ms)	Excess Gain—90% White Card	
	at 35 mm	at 310 mm
1.5	200	20
3	200	20
10	1000 (500)	100 (50)
25	2500 (1000)	250 (100)
50	5000 (2500)	500 (250)

¹

• **Std** excess gain available in 10 ms, 25 ms, and 50 ms response speeds only

²

• **Std** excess gain provides increased noise immunity

• **Std** excess gain available in 10 ms, 25 ms, and 50 ms response speeds only

• **Std** excess gain provides increased noise immunity

Delay at Power Up
< 750 ms

Maximum Torque
Side mounting: 1 N·m (9 in-lbs)
Nose mounting: 20 N·m (177 in-lbs)

Ambient Light Immunity
> 5,000 lux

Connector
Integral 5-pin M12/Euro-style male quick disconnect (OD)

Construction
Housing: 316 L stainless steel
Lens cover: PMMA acrylic
Lightpipe and display window: polysulfone

Chemical Compatibility
Compatible with commonly used acidic or caustic cleaning and disinfecting chemicals used in equipment cleaning and sanitation. ECOLAB® certified.
Compatible with typical cutting fluids and lubricating fluids used in machining centers

Application Note
For optimum performance, allow 10 minutes for the sensor to warm up

Environmental Rating
IEC IP67 per IEC60529
IEC IP68 per IEC60529
IEC IP69K per DIN40050-9

Vibration
MIL-STD-202G, Method 201A (10 Hz to 60 Hz, 0.06 inch (1.52 mm) double amplitude, 2 hours each along X, Y and Z axes), with sensor operating

Shock
MIL-STD-202G, Method 213B, Condition I (100G 6x along X, Y and Z axes, 18 total shocks), with sensor operating

Operating Conditions
-10 °C to +50 °C (+14 °F to +122 °F)
35% to 95% relative humidity

Storage Temperature
-25 °C to +75 °C (-13 °F to +167 °F)

Required Overcurrent Protection



WARNING: Electrical connections must be made by qualified personnel in accordance with local and national electrical codes and regulations.

Overcurrent protection is required to be provided by end product application per the supplied table.
Overcurrent protection may be provided with external fusing or via Current Limiting, Class 2 Power Supply.
Supply wiring leads < 24 AWG shall not be spliced.
For additional product support, go to <http://www.bannerengineering.com>.

Supply Wiring (AWG)	Required Overcurrent Protection (Amps)
20	5.0
22	3.0
24	2.0
26	1.0
28	0.8
30	0.5

Certifications



Class 2 power
UL Environmental Rating: Type 1



chemical compatibility certified

ECOLAB is a registered trademark of Ecolab USA Inc. All rights reserved.

Banner Engineering Corp. Limited Warranty

Banner Engineering Corp. warrants its products to be free from defects in material and workmanship for one year following the date of shipment. Banner Engineering Corp. will repair or replace, free of charge, any product of its manufacture which, at the time it is returned to the factory, is found to have been defective during the warranty period. This warranty does not cover damage or liability for misuse, abuse, or the improper application or installation of the Banner product.

THIS LIMITED WARRANTY IS EXCLUSIVE AND IN LIEU OF ALL OTHER WARRANTIES WHETHER EXPRESS OR IMPLIED (INCLUDING, WITHOUT LIMITATION, ANY WARRANTY OF MERCHANTABILITY OR FITNESS FOR A PARTICULAR PURPOSE), AND WHETHER ARISING UNDER COURSE OF PERFORMANCE, COURSE OF DEALING OR TRADE USAGE.

This Warranty is exclusive and limited to repair or, at the discretion of Banner Engineering Corp., replacement. IN NO EVENT SHALL BANNER ENGINEERING CORP. BE LIABLE TO BUYER OR ANY OTHER PERSON OR ENTITY FOR ANY EXTRA COSTS, EXPENSES, LOSSES, LOSS OF PROFITS, OR ANY INCIDENTAL, CONSEQUENTIAL OR SPECIAL DAMAGES RESULTING FROM ANY PRODUCT DEFECT OR FROM THE USE OR INABILITY TO USE THE PRODUCT, WHETHER ARISING IN CONTRACT OR WARRANTY, STATUTE, TORT, STRICT LIABILITY, NEGLIGENCE, OR OTHERWISE.

Banner Engineering Corp. reserves the right to change, modify or improve the design of the product without assuming any obligations or liabilities relating to any product previously manufactured by Banner Engineering Corp. Any misuse, abuse, or improper application or installation of this product or use of the product for personal protection applications when the product is identified as not intended for such purposes will void the product warranty. Any modifications to this product without prior express approval by Banner Engineering Corp will void the product warranties. All specifications published in this document are subject to change; Banner reserves the right to modify product specifications or update documentation at any time. Specifications and product information in English supersede that which is provided in any other language. For the most recent version of any documentation, refer to: www.bannerengineering.com.