

EZ-LIGHT® K50 Rotating and Strobing Beacon

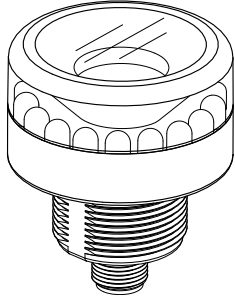

Datasheet

Daylight-visible, general-purpose indicators for indoor or outdoor use



- Intense levels of light output for areas with high ambient light - even outdoors
- Viewable around entire perimeter; strobing models also emit light from top
- Rotating and Strobing models
- Rugged, sealed thermoplastic housing rated for IP67 and IP69K
- Bright, even light
- 12 V dc to 30 V dc operation
- 12 V dc operation useful for applications on mobile vehicles



WARNING: Not To Be Used for Personnel Protection

Never use this device as a sensing device for personnel protection. Doing so could lead to serious injury or death. This device does not include the self-checking redundant circuitry necessary to allow its use in personnel safety applications. A sensor failure or malfunction can cause either an energized or de-energized sensor output condition.

Models

Model ¹	Function	Connection	LED Color	Input Voltage
K50BLR1XGXPQ	Rotating	Integral 5-pin M12/Euro-style male quick disconnect (QD)	Green	12 to 30 V dc
K50BLR1XRXPQ			Red	
K50BLR1YXPQ			Yellow	
K50BLR1XBX PQ			Blue	
K50BCLS1XGXPQ	Strobing		Green	
K50BCLS1XRXPQ			Red	
K50BCLS1YXPQ			Yellow	
K50BCLS1XBX PQ			Blue	

Wiring

Wire Color		Function for Rotating Models	Function for Strobing Models
Blue (3)	0 V dc	Common	Common
Black (4)	+V dc	ON continuous	ON continuous
Brown (1)	+V dc	Rotating at 90 rpm	Single pulse strobe at 1 Hz
White (2)	+V dc	Rotating at 180 rpm	Double pulse strobe at 1 Hz

Sourcing (PNP) Input	Integral 5-pin M12/Euro-style male quick disconnect (QD)	Wiring Key:
		<p>1 = Brown 2 = White 3 = Blue 4 = Black 5 = Gray (Not Used)</p>

¹

- To order the 150 mm PVC pigtail with quick disconnect (QD) model, replace Q with QP in model number (example, K50BLR1XGXPQP).
- To order the 2 m (6.5 ft) cable model, omit suffix Q from model number (example, K50BLR1XGXP).
- Models with a QD requires a mating cable (refer to the Accessories list).



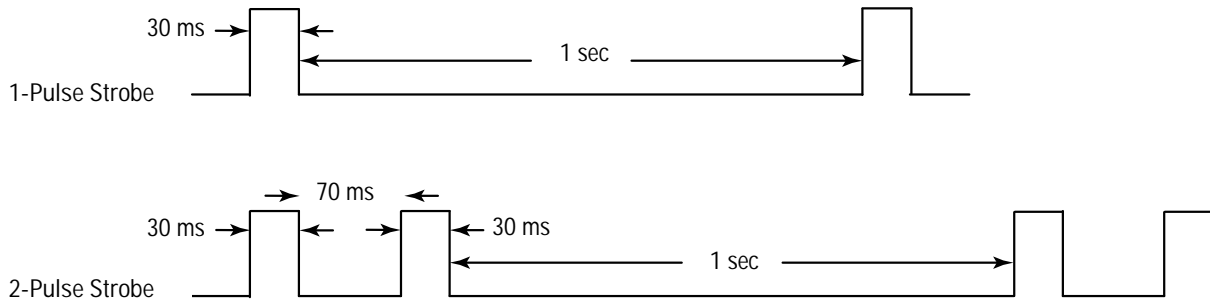

Figure 1. Timing diagram for 1 pulse or 2 pulses

Specifications

Supply Voltage and Current

12–30 V dc
 Rotating models: 140 mA maximum at 12 V dc, 70 mA maximum at 30 V dc
 Strobing models: 160 mA maximum at 12 V dc, 100 mA maximum at 30 V dc

Supply Protection Circuitry

Protected against reverse polarity and transient voltages

Indicators

LED function depends on the model and wiring (see [Wiring](#) on page 1)

Indicator Power-Up Response Time

ON: 250 ms

Construction

Base and covers: polycarbonate

Connections

Integral 5-pin M12/Euro-style male quick disconnect (QD) or 2 m (6.5 ft) integral cable, depending on model

Operating Conditions

–40 °C to +50 °C (–40 °F to +122 °F)
 90% @ 50 °C max. relative humidity (non-condensing)

Environmental Rating

Rated IEC IP67 and IP69K, per DIN 40050

Application Note

Light emits 360° from housing sides and from housing top, some models

Vibration and Mechanical Shock

All models meet Mil. Std. 202F requirements method 201A (vibration: 10 to 60 Hz max., double amplitude 0.06", maximum acceleration 10G). Also meets IEC 947-5-2; 30G 11 ms duration, half sine wave.

Certifications



Required Overcurrent Protection



WARNING: Electrical connections must be made by qualified personnel in accordance with local and national electrical codes and regulations.

Overcurrent protection is required to be provided by end product application per the supplied table.

Overcurrent protection may be provided with external fusing or via Current Limiting, Class 2 Power Supply.

Supply wiring leads < 24 AWG shall not be spliced.

For additional product support, go to <http://www.bannerengineering.com>.

Supply Wiring (AWG)	Required Overcurrent Protection (Amps)
20	5.0
22	3.0
24	2.0
26	1.0
28	0.8
30	0.5

Rotating Models

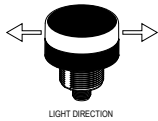

Strobing Models

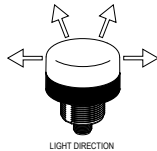

Dimensions

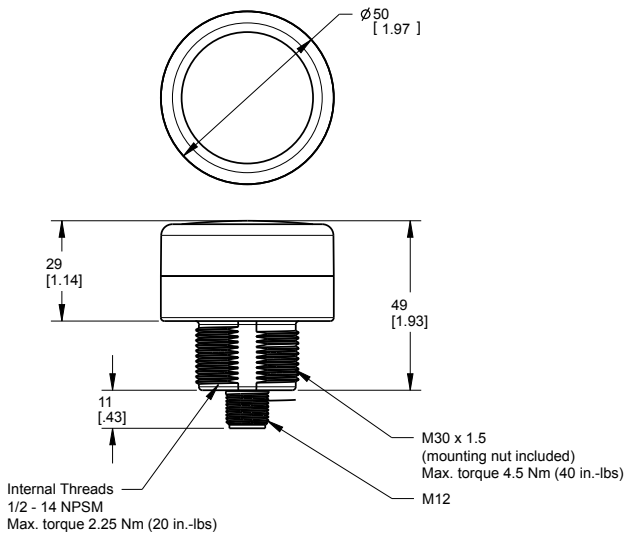

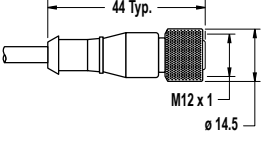
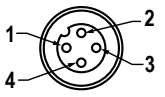
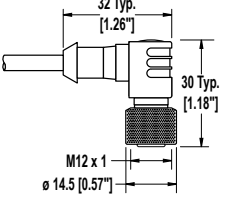

Accessories

Cordsets

4-Pin Threaded M12/Euro-Style Cordsets				
Model	Length	Style	Dimensions	Pinout (Female)
MQDC-406	1.83 m (6 ft)	Straight		 <p>1 = Brown 2 = White 3 = Blue 4 = Black</p>
MQDC-415	4.57 m (15 ft)			
MQDC-430	9.14 m (30 ft)			
MQDC-450	15.2 m (50 ft)			
MQDC-406RA	1.83 m (6 ft)	Right-Angle		
MQDC-415RA	4.57 m (15 ft)			
MQDC-430RA	9.14 m (30 ft)			
MQDC-450RA	15.2 m (50 ft)			

LMB Sealed Right-Angle Bracket

Model	Description	Construction	
LMB30RA	Direct-Mount Models: Bracket kit with base, 30 mm adapter, set screw, fasteners, o-rings, and gaskets	Black polycarbonate	
LMB30RAC		Gray polycarbonate	
LMBE12RA	Pipe-Mount Models: Bracket kit with base, ½-14 pipe adapter, set screw, fasteners, o-rings, and gaskets. For use with stand-off pipe (listed and sold separately)	Black polycarbonate	
LMBE12RAC		Gray polycarbonate	

Accessory Mounting Brackets

All measurements are in mm

SMB30A

- Right-angle bracket with curved slot for versatile orientation
- Clearance for M6 (¼ in) hardware
- Mounting hole for 30 mm sensor
- 12-ga. stainless steel

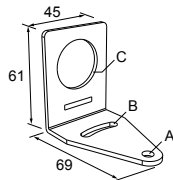

Hole center spacing: A to B=40
Hole size: A=ø 6.3, B= 27.1 x 6.3, C=ø 30.5

SMB30FA

- Swivel bracket with tilt and pan movement for precise adjustment
- Mounting hole for 30 mm sensor
- 12-ga. 304 stainless steel
- Easy sensor mounting to extrude rail T-slot
- Metric and inch size bolt available

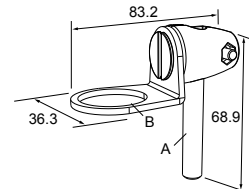

Bolt thread: SMB30FA, A= 3/8 - 16 x 2 in; SMB30FAM10, A= M10 - 1.5 x 50
Hole size: B= ø 30.1

SMB30MM

- 12-ga. stainless steel bracket with curved mounting slots for versatile orientation
- Clearance for M6 (¼ in) hardware
- Mounting hole for 30 mm sensor

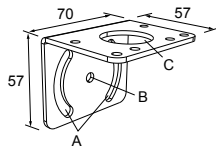

Hole center spacing: A = 51, A to B = 25.4
Hole size: A = 42.6 x 7, B = ø 6.4, C = ø 30.1

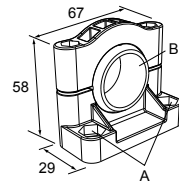

SMB30SC

- Swivel bracket with 30 mm mounting hole for sensor
- Black reinforced thermoplastic polyester
- Stainless steel mounting and swivel locking hardware included



Hole center spacing: A=ø 50.8
Hole size: A=ø 7.0, B=ø 30.0

Elevated Mount System

Model			Features	Components
SA-M30TE12 - Black Acetal			<ul style="list-style-type: none"> Streamlined black acetal or white UHMW stand-off pipe adapter/cover Connects between 30 mm light base and ½ in. NPSM/DN15 pipe Mounting hardware included 	
SA-M30TE12C - White UHMW				
Polished 304 Stainless Steel	Black Anodized Aluminum	Clear Anodized Aluminum	<ul style="list-style-type: none"> Elevated-use stand-off pipe (½ in. NPSM/DN15) Polished 304 stainless steel, black anodized aluminum, or clear anodized aluminum surface ½ in. NPT thread at both ends Compatible with most industrial environments 	
SOP-E12-150SS 150 mm (6 in) long	SOP-E12-150A 150 mm (6 in) long	SOP-E12-150AC 150 mm (6 in) long		
SOP-E12-300SS 300 mm (12 in) long	SOP-E12-300A 300 mm (12 in) long	SOP-E12-300AC 300 mm (12 in) long		
SOP-E12-900SS 900 mm (36 in) long	SOP-E12-900A 900 mm (36 in) long	SOP-E12-900AC 900 mm (36 in) long		
SA-E12M30 - Black Acetal			<ul style="list-style-type: none"> Streamlined black acetal or white UHMW mounting base adapter/cover Connects between ½ in. NPSM/DN15 pipe and 30 mm (1-3/16 in) drilled hole Mounting hardware included 	
SA-E12M30C - White UHMW				

Banner Engineering Corp. Limited Warranty

Banner Engineering Corp. warrants its products to be free from defects in material and workmanship for one year following the date of shipment. Banner Engineering Corp. will repair or replace, free of charge, any product of its manufacture which, at the time it is returned to the factory, is found to have been defective during the warranty period. This warranty does not cover damage or liability for misuse, abuse, or the improper application or installation of the Banner product.

THIS LIMITED WARRANTY IS EXCLUSIVE AND IN LIEU OF ALL OTHER WARRANTIES WHETHER EXPRESS OR IMPLIED (INCLUDING, WITHOUT LIMITATION, ANY WARRANTY OF MERCHANTABILITY OR FITNESS FOR A PARTICULAR PURPOSE), AND WHETHER ARISING UNDER COURSE OF PERFORMANCE, COURSE OF DEALING OR TRADE USAGE.

This Warranty is exclusive and limited to repair or, at the discretion of Banner Engineering Corp., replacement. IN NO EVENT SHALL BANNER ENGINEERING CORP. BE LIABLE TO BUYER OR ANY OTHER PERSON OR ENTITY FOR ANY EXTRA COSTS, EXPENSES, LOSSES, LOSS OF PROFITS, OR ANY INCIDENTAL, CONSEQUENTIAL OR SPECIAL DAMAGES RESULTING FROM ANY PRODUCT DEFECT OR FROM THE USE OR INABILITY TO USE THE PRODUCT, WHETHER ARISING IN CONTRACT OR WARRANTY, STATUTE, TORT, STRICT LIABILITY, NEGLIGENCE, OR OTHERWISE.

Banner Engineering Corp. reserves the right to change, modify or improve the design of the product without assuming any obligations or liabilities relating to any product previously manufactured by Banner Engineering Corp. Any misuse, abuse, or improper application or installation of this product or use of the product for personal protection applications when the product is identified as not intended for such purposes will void the product warranty. Any modifications to this product without prior express approval by Banner Engineering Corp will void the product warranties. All specifications published in this document are subject to change: Banner reserves the right to modify product specifications or update documentation at any time. Specifications and product information in English supersede that which is provided in any other language. For the most recent version of any documentation, refer to: www.bannerengineering.com.