

# TL50Z Universal AC Voltage Tower Light

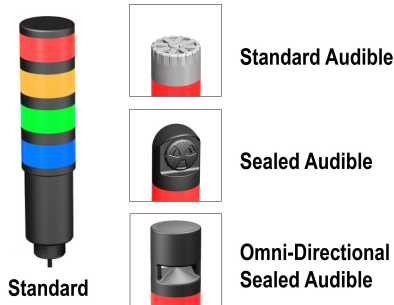

## Datasheet

Multi-Color General-Purpose or Audible Indicators



- Rugged, cost-effective, and easy-to-install multi-segment indicators
- Illuminated segments provide easy-to-see operator guidance and indication of equipment status
- Displays up to 5 colors
- Available in black or light gray housing
- Audible models available with standard, sealed, or omni-directional audible element
- Compact devices are completely self-contained, no controller needed
- 100 V ac to 240 V ac operation
- No assembly required

## Non-Audible Models

Model <sup>1</sup>	# of LED Colors	LED Colors <sup>2</sup>	Connection <sup>3</sup>	Inputs
TL50ZR	1	Red	4-wire PVC cable	100 V ac to 240 V ac
TL50ZGR	2	Green, Red		
TL50ZGYR	3	Green, Yellow, Red	5-wire PVC cable	
TL50ZBGYR	4	Blue, Green, Yellow, Red		
TL50ZWBGYR	5	White, Blue, Green, Yellow, Red	6-wire PVC cable	

## Audible Models

Standard Audible Model <sup>1</sup>	# of LED Colors	LED Colors <sup>2</sup>	Connection <sup>3</sup>	Inputs
TL50ZRA	1	Red	4-wire PVC cable	100 V ac to 240 V ac
TL50ZGRA	2	Green, Red		
TL50ZGYRA	3	Green, Yellow, Red	5-wire PVC cable	
TL50ZBGYRA	4	Blue, Green, Yellow, Red	6-wire PVC cable	

Sealed Audible Model <sup>1</sup>			# of LED Colors	LED Colors <sup>2</sup>	Connection <sup>3</sup>	Inputs
Continuous	Pulsed at 1.6 Hz	Staccato				
TL50ZRALS	TL50ZRALS3	TL50ZRALS4	1	Red	4-wire PVC cable	100 V ac to 240 V ac
TL50ZGRALS	TL50ZGRALS3	TL50ZGRALS4	2	Green, Red		
TL50ZGYRALS	TL50ZGYRALS3	TL50ZGYRALS4	3	Green, Yellow, Red	5-wire PVC cable	
TL50ZBGYRALS	TL50ZBGYRALS3	TL50ZBGYRALS4	4	Blue, Green, Yellow, Red	6-wire PVC cable	

<sup>1</sup> Models with black housing are listed. For gray housing, add the suffix "C" at the end of the cabled model number or before the "QP" in 150 mm (6 in) PVC cable model numbers. For example, TL50ZRC or TL50ZRCQP.

<sup>2</sup> The first color listed is the bottom color, going up in successive order. Other available colors include: Turquoise (T), Orange (O), Violet (V), Sky Blue (S) and Magenta (M). Four color options are only available in audible cabled models. Five color options are only available in non-audible cabled models.

<sup>3</sup>

- To order the 150 mm (6 in) PVC cable model, add the suffix "QP" to the model number. For example, TL50ZRQP.
- Models with a quick disconnect require a mating cordset.



Omni-Directional Sealed Audible Model <sup>1</sup>			# of LED Colors	LED Colors <sup>2</sup>	Connection <sup>3</sup>	Inputs
Continuous	Pulsed at 1.6 Hz	Staccato				
TL50ZRAOS	TL50ZRAOS3	TL50ZRAOS4	1	Red	4-wire PVC cable	100 V ac to 240 V ac
TL50ZGRAOS	TL50ZGRAOS3	TL50ZGRAOS4	2	Green, Red		
TL50ZGYRAOS	TL50ZGYRAOS3	TL50ZGYRAOS4	3	Green, Yellow, Red	5-wire PVC cable	
TL50ZBGYRAOS	TL50ZBGYRAOS3	TL50ZBGYRAOS4	4	Blue, Green, Yellow, Red	6-wire PVC cable	

Omni-Directional Sealed Audible Model with Intensity Adjustment <sup>1</sup>			# of LED Colors	LED Colors <sup>2</sup>	Connection <sup>3</sup>	Inputs
Continuous	Pulsed at 1.6 Hz	Staccato				
TL50ZRAOSI	TL50ZRAOS3I	TL50ZRAOS4I	1	Red	4-wire PVC cable	100 V ac to 240 V ac
TL50ZGRAOSI	TL50ZGRAOS3I	TL50ZGRAOS4I	2	Green, Red		
TL50ZGYRAOSI	TL50ZGYRAOS3I	TL50ZGYRAOS4I	3	Green, Yellow, Red	5-wire PVC cable	
TL50ZBGYRAOSI	TL50ZBGYRAOS3I	TL50ZBGYRAOS4I	4	Blue, Green, Yellow, Red	6-wire PVC cable	

## Wiring Diagrams

Models with 1 to 3 Segments  
4-Wire

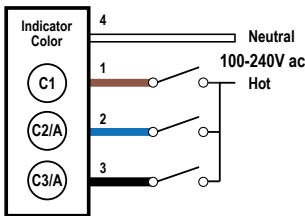

Models with 4 Segments  
5-Wire

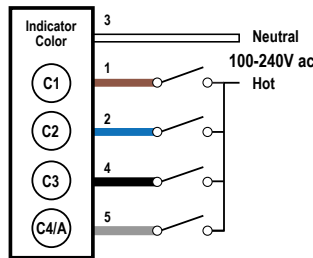

Models with 5 Segments  
6-Wire

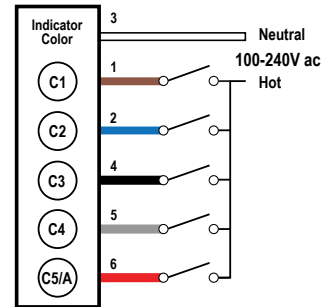

### 4-Wire Key:

- 1 = Brown
- 2 = Blue
- 3 = Black
- 4 = White
- C1 = Color 1
- C2 = Color 2
- C3 = Color 3
- A = Audible

### 5-Wire Key:

- 1 = Brown
- 2 = Blue
- 3 = White
- 4 = Black
- 5 = Gray
- C1 = Color 1
- C2 = Color 2
- C3 = Color 3
- C4 = Color 4
- A = Audible

### 6-Wire Key:

- 1 = Brown
- 2 = Blue
- 3 = White
- 4 = Black
- 5 = Gray
- 6 = Red
- C1 = Color 1
- C2 = Color 2
- C3 = Color 3
- C4 = Color 4
- C5 = Color 5
- A = Audible

## Specifications

### Supply Voltage and Current

100 V ac to 240 V ac at 50 Hz or 60 Hz

#### Indicators—maximum current per LED color:

- 35 mA at 100 V ac
- 30 mA at 120 V ac
- 20 mA at 240 V ac

**Standard Audible Alarm:** 30 mA maximum current

**Sealed Audible Alarm:** 35 mA maximum current

**Omni-Directional Sealed Audible Alarm:** 45 mA maximum current

### Supply Protection Circuitry

Protected against transient voltages

### Connections

4-wire, 5-wire, or 6-wire 2 m (6.5 ft) integral cable, 4-pin or 5-pin 150 mm (6 in) PVC cable with a M12/Euro-style quick disconnect, depending on model. Models with a quick disconnect require a mating cordset.

### Construction

**Bases and Covers:** ABS

**Light Segment:** Polycarbonate

### Vibration and Mechanical Shock

Meets IEC 60068-2-6 requirements (Vibration: 10 Hz to 55 Hz, 1.0 mm amplitude, 5 minutes sweep, 30 minutes dwell)

Meets IEC 60068-2-27 requirements (Shock: 30G 11 ms duration, half sine wave)

**Input Response Time**

Indicator On/Off: 500 milliseconds maximum

**Leakage Current Immunity**

500 µA

Application Note: The use of relay output PLC is recommended since there is no leakage current. Solid state output PLCs often have leakage current above 1 mA and, therefore, turn the light on in the off state. To counteract the leakage current, a shunt resistor must be used. A resistor must be applied from the neutral wire of the device to the hot wire of each channel of the device.

**Audible Alarm**

**Standard Audible Alarm:** 2.7 kHz ± 500 Hz oscillation frequency; maximum intensity 92 dB at 1 m (3.3 ft) (typical)

**Standard Audible Alarm:** 2.7 kHz ± 500 Hz oscillation frequency; maximum intensity 92 dB at 1 m (3.3 ft) (typical)

**Omni-Directional Sealed Audible Alarm:** 2.1 kHz ± 250 Hz oscillation frequency; maximum intensity 99 dB at 1 m (3.3 ft) (typical)

**Omni-Directional Sealed Audible Alarm with Intensity Adjustment:** 2.1 kHz ± 250 Hz oscillation frequency; maximum intensity 95 dB at 1 m (3.3 ft) (typical)

**Typical Reduction in Sound Intensity with Audible Adjustment (maximum to minimum)**

- **Standard Audible:** 30 dB
- **Sealed Audible:** 20 dB
- **Omni-Directional Sealed Audible:** 12 dB

**Audible Adjustment**

**Standard Audible Alarm:** Unscrew the cover (up to 1.5 turns maximum) to adjust the audible intensity. (Do not exceed 1.5 turns or the cover may detach during operation.) For maximum intensity, rotate the center plug 180° counterclockwise to remove it.

**Sealed Audible Alarm and Omni-Directional Sealed Audible Alarm with Intensity Adjustment:** Rotate the front cover until the desired intensity is reached.

**Omni-Directional Sealed Audible Alarm:** No adjustment.

**Operating Conditions**

**Non-Audible:** -40 °C to +50 °C (-40 °F to +122 °F)

**Standard and Sealed Audible:** -20 °C to +50 °C (-4 °F to +122 °F)  
90% at +50 °C maximum relative humidity (non-condensing)

**Environmental Rating**

NEMA/UL Type 13, 4X Indoor

**Non-Audible and Sealed Audible:** IEC IP67

**Standard Audible:** IEC IP50

**Certifications**



**Indicators**

LEDs are independently selected; 1 to 5 colors depending on model

**Indicator Characteristics**

Color	Dominant Wavelength (nm) or Color Temperature (CCT)	Color Coordinates <sup>4</sup>		Lumen Output (Typical at 25 °C)
		x	y	
Green	528 nm	-	-	23.0
Red	625 nm	-	-	7.5
Yellow	590 nm	-	-	5.0
Blue	470 nm	-	-	4.0
Orange	608 nm	-	-	15.5
White	6000 K	-	-	21.0
Turquoise	-	0.19	0.37	5.5
Violet	-	0.20	0.08	2.5
Magenta	-	0.35	0.15	3.0
Sky Blue	-	0.19	0.26	12.0

**Required Overcurrent Protection**



**WARNING:** Electrical connections must be made by qualified personnel in accordance with local and national electrical codes and regulations.

Overcurrent protection is required to be provided by end product application per the supplied table. Overcurrent protection may be provided with external fusing or via Current Limiting, Class 2 Power Supply. Supply wiring leads < 24 AWG shall not be spliced. For additional product support, go to [www.bannerengineering.com](http://www.bannerengineering.com).

Supply Wiring (AWG)	Required Overcurrent Protection (Amps)
20	5.0
22	3.0
24	2.0
26	1.0
28	0.8
30	0.5

<sup>4</sup> Refer to CIE 1931 chromaticity diagram or color chart, to show equivalent color with indicated color coordinates.

## Dimensions

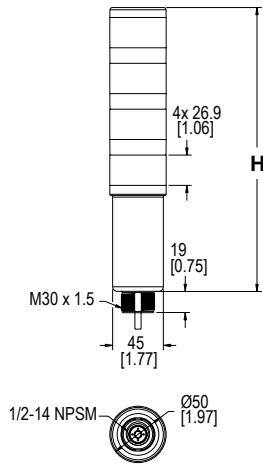

# of Colors	Tower Height (H)			
	Non-Audible	Standard Audible*	Sealed Audible	Omni-Directional Sealed Audible
1	130.2 mm (5.1 in)	161.0 mm (6.3 in)	184.1 mm (7.2 in)	198.1 mm (7.8 in)
2	170.9 mm (6.7 in)	201.7 mm (7.9 in)	224.8 mm (8.9 in)	238.8 mm (9.4 in)
3	211.6 mm (8.3 in)	242.4 mm (9.5 in)	265.5 mm (10.5 in)	279.5 mm (11.0 in)
4	252.3 mm (9.9 in)	283.1 mm (11.1 in)	306.2 mm (12.1 in)	320.2 mm (12.6 in)
5	293.0 mm (11.5 in)	-	-	-

\* Tower height (H) with top unscrewed approximately 3.5 mm to allow sound to escape

All measurements are listed in millimeters [inches], unless noted otherwise.

## Accessories

### Cordsets

4-Pin Micro-Style Cordsets				
Model	Length	Style	Dimensions	Pinout (Female)
MQAC2-406	1.83 m (6 ft)	Straight		<p>1 = Brown 2 = Blue 3 = Black 4 = White</p>
MQAC2-415	4.57 m (15 ft)			
MQAC2-430	9.14 m (30 ft)			

5-Pin Micro-Style Cordsets				
Model	Length	Style	Dimensions	Pinout
MQAC2-506	1.83 m (6 ft)	Straight		<p>1 = Brown 2 = Blue 3 = White 4 = Black 5 = Gray</p>
MQAC2-515	4.57 m (15 ft)			
MQAC2-530	9.14 m (30 ft)			

## Mounting Brackets

### SMB30A

- Right-angle bracket with curved slot for versatile orientation
- Clearance for M6 (1/4 in) hardware
- Mounting hole for 30 mm sensor
- 12-ga. stainless steel

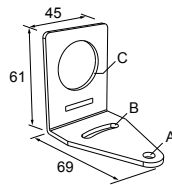

**Hole center spacing:** A to B=40

**Hole size:** A=ø 6.3, B= 27.1 x 6.3, C=ø 30.5

### SMB30FA

- Swivel bracket with tilt and pan movement for precise adjustment
- Mounting hole for 30 mm sensor
- 12-ga. 304 stainless steel
- Easy sensor mounting to extrude rail T-slot
- Metric and inch size bolt available

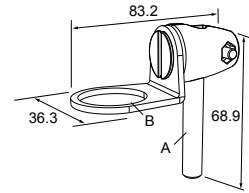

**Bolt thread:** SMB30FA, A= 3/8 - 16 x 2 in; SMB30FAM10, A= M10 - 1.5 x 50

**Hole size:** B= ø 30.1

### SMB30MM

- 12-ga. stainless steel bracket with curved mounting slots for versatile orientation
- Clearance for M6 (1/4 in) hardware
- Mounting hole for 30 mm sensor

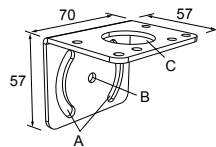

**Hole center spacing:** A = 51, A to B = 25.4

**Hole size:** A = 42.6 x 7, B = ø 6.4, C = ø 30.1

### SMBAMS30P

- Flat SMBAMS series bracket
- 30 mm hole for mounting sensors
- Articulation slots for 90°+ rotation
- 12-ga. 300 series stainless steel

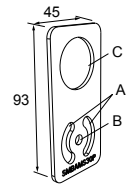

**Hole center spacing:** A=26.0, A to B=13.0

**Hole size:** A=26.8 x 7.0, B=ø 6.5, C=ø 31.0

### SMBAMS30RA

- Right-angle SMBAMS series bracket
- 30 mm hole for mounting sensors
- Articulation slots for 90°+ rotation
- 12-ga. (2.6 mm) cold-rolled steel

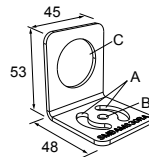

**Hole center spacing:** A=26.0, A to B=13.0

**Hole size:** A=26.8 x 7.0, B=ø 6.5, C=ø 31.0

### SMB30SC

- Swivel bracket with 30 mm mounting hole for sensor
- Black reinforced thermoplastic polyester
- Stainless steel mounting and swivel locking hardware included

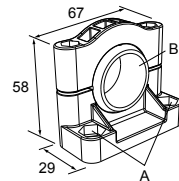



**Hole center spacing:** A=ø 50.8



**Hole size:** A=ø 7.0, B=ø 30.0

All measurements are listed in millimeters [inches], unless noted otherwise.

## LMB Sealed Right-Angle Bracket

Model	Description	Construction	
LMB30RA	<b>Direct-Mount Models:</b> Bracket kit with base, 30 mm adapter, set screw, fasteners, O-rings, and gaskets.	Black polycarbonate	
LMB30RAC		Gray polycarbonate	
LMBE12RA	<b>Pipe-Mount Models:</b> Bracket kit with base, 1/2-14 pipe adapter, set screw, fasteners, O-rings, and gaskets. For use with stand-off pipe (listed and sold separately).	Black polycarbonate	
LMBE12RAC		Gray polycarbonate	

## Elevated Mount System

Model			Features	Components
SA-M30TE12 - Black Acetal			<ul style="list-style-type: none"> <li>Streamlined black acetal or white UHMW stand-off pipe adapter/cover</li> <li>Connects between 30 mm light base and ½ in. NPSM/DN15 pipe</li> <li>Mounting hardware included</li> </ul>	
SA-M30TE12C - White UHMW				
Polished 304 Stainless Steel	Black Anodized Aluminum	Clear Anodized Aluminum	<ul style="list-style-type: none"> <li>Elevated-use stand-off pipe (½ in. NPSM/DN15)</li> <li>Polished 304 stainless steel, black anodized aluminum, or clear anodized aluminum surface</li> <li>½ in. NPT thread at both ends</li> <li>Compatible with most industrial environments</li> </ul>	
SOP-E12-150SS 150 mm (6 in) long	SOP-E12-150A 150 mm (6 in) long	SOP-E12-150AC 150 mm (6 in) long		
SOP-E12-300SS 300 mm (12 in) long	SOP-E12-300A 300 mm (12 in) long	SOP-E12-300AC 300 mm (12 in) long		
SOP-E12-900SS 900 mm (36 in) long	SOP-E12-900A 900 mm (36 in) long	SOP-E12-900AC 900 mm (36 in) long		
SA-E12M30 - Black Acetal			<ul style="list-style-type: none"> <li>Streamlined black acetal or white UHMW mounting base adapter/cover</li> <li>Connects between ½ in. NPSM/DN15 pipe and 30 mm (1-3/16 in) drilled hole</li> <li>Mounting hardware included</li> </ul>	
SA-E12M30C - White UHMW				

## Pipe Mounting Flange

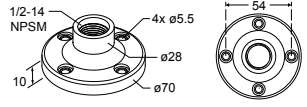
Pipe Mounting Flange			
Model	Features	Construction	
SA-F12	<ul style="list-style-type: none"> <li>For use elevated stand-off pipes (½ in, NPSM/DN15)</li> <li>M5 mounting hardware and nitrile gasket included</li> </ul>	Die-cast zinc base with black paint	

## Banner Engineering Corp. Limited Warranty

Banner Engineering Corp. warrants its products to be free from defects in material and workmanship for one year following the date of shipment. Banner Engineering Corp. will repair or replace, free of charge, any product of its manufacture which, at the time it is returned to the factory, is found to have been defective during the warranty period. This warranty does not cover damage or liability for misuse, abuse, or the improper application or installation of the Banner product.

**THIS LIMITED WARRANTY IS EXCLUSIVE AND IN LIEU OF ALL OTHER WARRANTIES WHETHER EXPRESS OR IMPLIED (INCLUDING, WITHOUT LIMITATION, ANY WARRANTY OF MERCHANTABILITY OR FITNESS FOR A PARTICULAR PURPOSE), AND WHETHER ARISING UNDER COURSE OF PERFORMANCE, COURSE OF DEALING OR TRADE USAGE.**

This Warranty is exclusive and limited to repair or, at the discretion of Banner Engineering Corp., replacement. **IN NO EVENT SHALL BANNER ENGINEERING CORP. BE LIABLE TO BUYER OR ANY OTHER PERSON OR ENTITY FOR ANY EXTRA COSTS, EXPENSES, LOSSES, LOSS OF PROFITS, OR ANY INCIDENTAL, CONSEQUENTIAL OR SPECIAL DAMAGES RESULTING FROM ANY PRODUCT DEFECT OR FROM THE USE OR INABILITY TO USE THE PRODUCT, WHETHER ARISING IN CONTRACT OR WARRANTY, STATUTE, TORT, STRICT LIABILITY, NEGLIGENCE, OR OTHERWISE.**

Banner Engineering Corp. reserves the right to change, modify or improve the design of the product without assuming any obligations or liabilities relating to any product previously manufactured by Banner Engineering Corp. Any misuse, abuse, or improper application or installation of this product or use of the product for personal protection applications when the product is identified as not intended for such purposes will void the product warranty. Any modifications to this product without prior express approval by Banner Engineering Corp will void the product warranties. All specifications published in this document are subject to change; Banner reserves the right to modify product specifications or update documentation at any time. Specifications and product information in English supersede that which is provided in any other language. For the most recent version of any documentation, refer to: [www.bannerengineering.com](http://www.bannerengineering.com).