

EZ-LIGHT® K50L with Independent Push Button Contact



Datasheet

EZ-LIGHT® with Three Colors and a Momentary Push Button Output

To view or download the latest technical information about this product, including specifications, dimensions, accessories, and wiring, see www.bannerengineering.com.

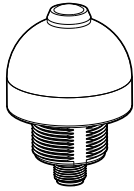

- Three PNP inputs control the green, amber, and red indicator lights
- Push button is mapped to a dry contact output
- 18 V dc to 30 V dc operation
- Ideal for use in abusive environments, featuring rugged, fully encapsulated construction
- Cabled and M12/Euro-style quick disconnect models available
- Includes an isolated push button and is optimized to work with SureCross® FlexPower® devices



WARNING: Not To Be Used for Personnel Protection

Never use this device as a sensing device for personnel **protection**. Doing so could lead to serious injury or death. This device does not include the self-checking redundant circuitry necessary to allow its use in personnel safety applications. A sensor failure or malfunction can cause either an energized or de-energized sensor output condition.

Models

Model	LEDs	Output	Connection ¹
K50LGRYPPB1Q	Green, Red, Amber	Momentary dry contact	Integral 5-pin M12/Euro-style quick disconnect (QD)

Wiring Diagram

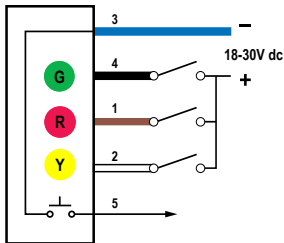

Key

1. Brown – PNP Input for red LED
2. White – PNP Input for amber LED
3. Blue – Ground
4. Black – PNP Input for green LED
5. Gray – NPN Output

¹ Integral 5-pin M12/Euro-style quick disconnect models are listed.

- To order the 2 m (6.5 ft) PVC cable model, omit the suffix "Q" in the model number. For example, K50LGRYPPB1.
- To order the 150 mm (6 in) PVC cable model with a M12/Euro-style quick disconnect, add the suffix "QP" to the model number. For example, K50LGRYPPB1QP.
- To order the 9 m (30 ft) PVC cable model, replace the suffix "Q" with "W/30" in the model number. For example, K50LGRYPPB1 W/30.
- Models with a quick disconnect require a mating cordset.



Specifications

Supply Voltage and Current

18 V dc to 30 V dc at 40 mA maximum per LED color

Supply Protection Circuitry

Protected against transient voltages and reverse polarity

Switch Contact Rating

150 mA at 30 V dc

Contact Bounce

10 ms maximum

Construction

Base: polycarbonate
Translucent dome: polycarbonate
Push button: thermoplastic

Indicators

Entire translucent diffuser or dome provides indication
LEDs are independently selected: Green, Red, Amber

Connections

Integral 5-pin M12/Euro-style quick disconnect, 2 m (6.5 ft) PVC jacketed cable, depending on model

Operating Temperature

-30 °C to +50 °C (-22 °F to +122 °F)

Max. Relative Humidity

90% at +50 °C maximum relative humidity (non-condensing)

Storage Temperature

-40 °C to +70 °C (-40 °F to +158 °F)

Environmental Rating

IEC IP67
NEMA/UL Type 4X, 13

Certifications



Dimensions

All measurements are listed in millimeters [inches], unless noted otherwise.

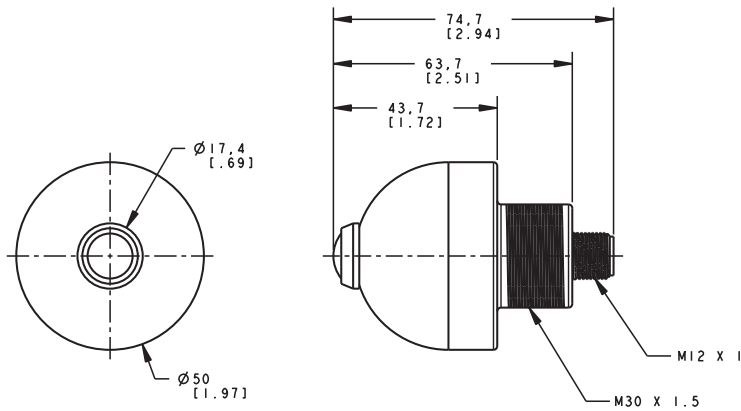

Accessories

Brackets

SMB30A

- Right-angle bracket with curved slot for versatile orientation
- Clearance for M6 (¼ in) hardware
- Mounting hole for 30 mm sensor
- 12-ga. stainless steel

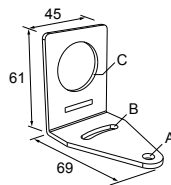

Hole center spacing: A to B=40

Hole size: A=ø 6.3, B= 27.1 x 6.3, C=ø 30.5

Cordsets

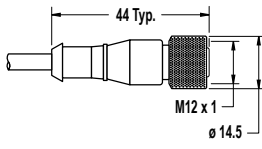
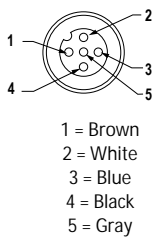
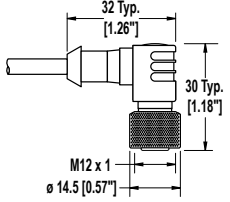
5-Pin Threaded M12/Euro-Style Cordsets—Single Ended				
Model	Length	Style	Dimensions	Pinout (Female)
MQDC1-501.5	0.50 m (1.5 ft)	Straight		
MQDC1-506	1.83 m (6 ft)			
MQDC1-515	4.57 m (15 ft)			
MQDC1-530	9.14 m (30 ft)			
MQDC1-506RA	1.83 m (6 ft)	Right-Angle		
MQDC1-515RA	4.57 m (15 ft)			
MQDC1-530RA	9.14 m (30 ft)			

Banner Engineering Corp. Limited Warranty

Banner Engineering Corp. warrants its products to be free from defects in material and workmanship for one year following the date of shipment. Banner Engineering Corp. will repair or replace, free of charge, any product of its manufacture which, at the time it is returned to the factory, is found to have been defective during the warranty period. This warranty does not cover damage or liability for misuse, abuse, or the improper application or installation of the Banner product.

THIS LIMITED WARRANTY IS EXCLUSIVE AND IN LIEU OF ALL OTHER WARRANTIES WHETHER EXPRESS OR IMPLIED (INCLUDING, WITHOUT LIMITATION, ANY WARRANTY OF MERCHANTABILITY OR FITNESS FOR A PARTICULAR PURPOSE), AND WHETHER ARISING UNDER COURSE OF PERFORMANCE, COURSE OF DEALING OR TRADE USAGE.

This Warranty is exclusive and limited to repair or, at the discretion of Banner Engineering Corp., replacement. IN NO EVENT SHALL BANNER ENGINEERING CORP. BE LIABLE TO BUYER OR ANY OTHER PERSON OR ENTITY FOR ANY EXTRA COSTS, EXPENSES, LOSSES, LOSS OF PROFITS, OR ANY INCIDENTAL, CONSEQUENTIAL OR SPECIAL DAMAGES RESULTING FROM ANY PRODUCT DEFECT OR FROM THE USE OR INABILITY TO USE THE PRODUCT, WHETHER ARISING IN CONTRACT OR WARRANTY, STATUTE, TORT, STRICT LIABILITY, NEGLIGENCE, OR OTHERWISE.

Banner Engineering Corp. reserves the right to change, modify or improve the design of the product without assuming any obligations or liabilities relating to any product previously manufactured by Banner Engineering Corp. Any misuse, abuse, or improper application or installation of this product or use of the product for personal protection applications when the product is identified as not intended for such purposes will void the product warranty. Any modifications to this product without prior express approval by Banner Engineering Corp will void the product warranties. All specifications published in this document are subject to change; Banner reserves the right to modify product specifications or update documentation at any time. Specifications and product information in English supersede that which is provided in any other language. For the most recent version of any documentation, refer to:

www.bannerengineering.com.