

WLB32 Industrial LED Light Bar (AC)



Datasheet



Model without Motion Detector

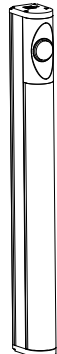

Model with Motion Detector



Model with Eye Shield and Motion Detector

Banner's WLB32 is an ultra-bright LED fixture that features an even light output for a no glare 'glow'. Suitable for a variety of environments and applications, including work stations, machine lighting, control cabinets, and manufacturing lines, the WLB32 uses advanced LED lighting technology to provide a high-quality and maintenance free industrial lighting solution for years.

- Highly energy efficient for overall cost savings
- High/Low/Off switch
- Models with eye shield block side glare
- Daisy chain power to multiple lights
- Motion detection models available
- Metal housing, shatterproof window
- Easy installation with snap clips, or a choice of magnetic or angle brackets

WLB32 Industrial LED Light Bars are available as cascadable models that can be "daisy-chained" together for a continuous length of lighting, with a minimum of wiring. Each light bar can be turned to high, low, or off independently of the other lights, upstream or downstream, in the chain. A double-ended accessory cordset must be used between each pair of cascading lights.

90 to 264 V ac Models			
Models	Lighted Length (mm)	Connector	Lumens
WLB32ZC285PBQMB	285	Custom Quick Disconnect	650
WLB32ZC570PBQMB	570		1300
WLB32ZC850PBQMB	850		1950
WLB32ZC1130PBQMB	1130		2600

The listed models include a U.S. power cable.

- To order model with no power cable, omit the suffix "B" from the model number. For example, WLB32ZC285PBQM. For a list of other countries' wall plug cables, refer to the Accessories list.
- To order the light without the integral switch, omit the "PB" from the model number. For example, WLB32ZC285QMB.
- To order the light with the integral motion detector, replace the 'PB' from the model number with 'M'. For example, WLB32ZC285MQMB.
- To order the light with the eye shield, add an 'E' after the length. For example, WLB32ZC285EPBQMB.



Installing the WLB32 AC Series Lights

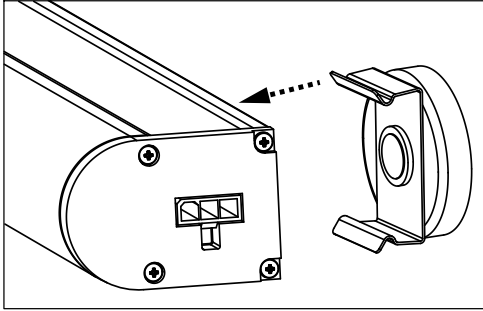

Figure 1. Attaching the Snap Brackets (Step 1)

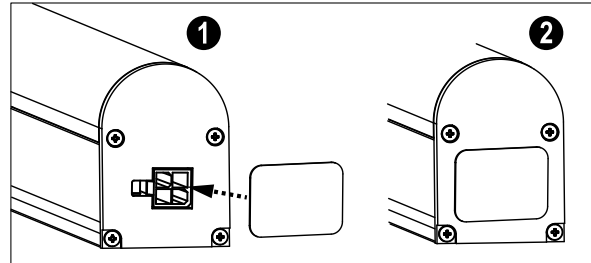

Figure 2. Installing the Cascade Cover (Step 8)

1. Attach the snap brackets to the light.
2. Select a suitable horizontal or vertical dry mounting location.
3. Place the light in the mounting location and mark the positions of the snap bracket mounting holes.
4. Drill the holes and use appropriate screws to secure the snap bracket to the mounting location.
5. Snap the light onto the brackets.
6. When daisy chaining multiple lights, follow steps 1 through 5 to mount additional lights. See the application note in the *Specifications* for the maximum allowed lights daisy chained together and maximum allowed cable run when choosing mounting locations.
7. Connect the daisy chained units together using cascade cordsets (see *Accessories*).
8. Install the supplied cascade cover over the output connector on the last light in the chain.
9. Plug the power cord from the first light into the wall outlet.



CAUTION: To reduce the risk of fire, electric shock, or injury to personnel:

- Use only insulated staples or plastic ties to secure cords;
- Route and secure cords so that they will not be pinched or damaged when the cabinet is pushed to the wall;
- Position the portable cabinet light with respect to the cabinet so the lamp replacement markings are able to be read during relamping;
- Do not recess into ceilings or soffits; and
- Do not conceal the cords. The National Electrical Code (NEC) does not permit cords to be concealed where damage to insulation may go unnoticed. To prevent fire danger, do not run cord behind walls, ceilings, soffits, or cabinets where it may be inaccessible for examination. Cords should be visually examined periodically and immediately replaced when any damage is noted.

Specifications

Operating Voltage

90 to 264 V ac (50 or 60 Hz)

Power factor > 0.95 on high setting at 120 V ac

Supply Current

Light Length (mm)	Max Current Draw (A) at 90 V ac	Typical Current Draw (A)	
		120 V ac	230 V ac
285	0.125	0.075	0.045
570	0.250	0.150	0.080
850	0.375	0.225	0.115
1130	0.500	0.300	0.150

Supply Protection Circuitry
Protected against transient voltages

Light Characteristics
Color: Daylight white
Color temperature (CCT): 5000K (±300K)
Lumen output: 650 (±5%) per foot, typical at 25 °C (77 °F)
CRI: 85 typical
Eye shield reduces lumens by approximately 25%

LED Lifetime
Lumen Maintenance - L70
When operating within specifications, output will decrease less than 30% after 50,000 hours.

Push Button
II = 100% light intensity
I = 50% light intensity
O = Standby

Models with Motion Detection
Light turns off after approximately 60 seconds without detecting motion.
Range: 12 m; ±45° field of view
Standby current: 170 µA

Construction
Anodized aluminum housing; polycarbonate window and end caps; stainless steel mounting brackets

Spacing Criterion
Vertical: 1.22
Horizontal: 1.32

Mounting
Snap clips; optional magnetic mount or swivel bracket accessories available

Connections
Integral custom QD (connecting cordset required)

Environmental Rating
IEC IP50

Vibration and Mechanical Shock
Vibration 10-55 Hz 1.0 mm p-p amplitude per IEC60068-2-6
Shock 15G 11 ms duration, half sine wave per IEC60068-2-27

Operating Temperature
-25 °C to +45 °C (-13 °F to 113 °F)
Models with Motion Detection: -20 °C to +45 °C (-4 °F to +113 °F)

Storage Temperature
-40 °C to +70 °C (-40 °F to +158 °F)

Test Data
LM-79, LM-80, TM-21

Certifications



UL Listed only for 120 V ac, 60 Hz

UL Recognized for easy installation in control cabinets

Application Note

When connecting cascading lights in series, do not exceed the maximum unit limit of 10, regardless of light size, and do not exceed a maximum wiring distance of 100 m (328 ft)

Spacing Criteria (SC)

The spacing criteria is the fixture-spacing-to-mounting-height ratio and aids in laying out a pattern of fixtures. Multiply the spacing criteria by the mounting height to get the maximum fixture spacing that still provides even illumination (no shadowing between fixtures).

$$\text{Luminaire Spacing} = \text{SC} \times \text{Height to Illuminated Plane}$$

The mounting height is the distance from the fixture to the surface you are lighting.

Light Characteristics

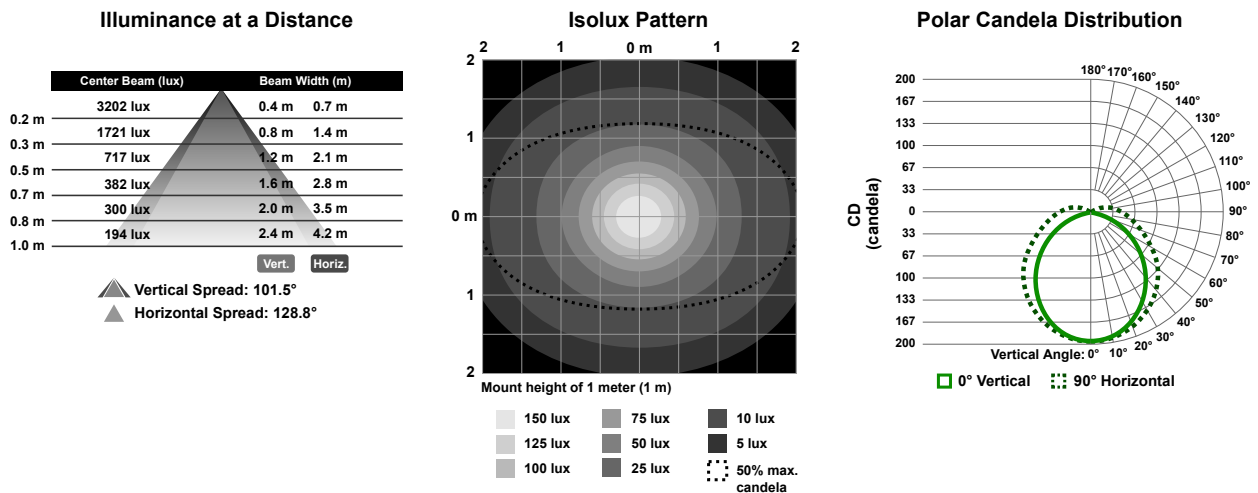
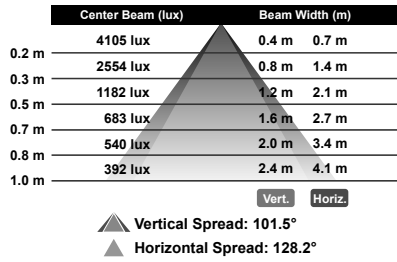
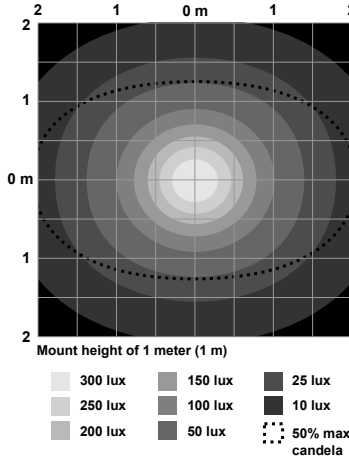

Figure 3. 285 mm Models

Illuminance at a Distance



Isolux Pattern



Polar Candela Distribution

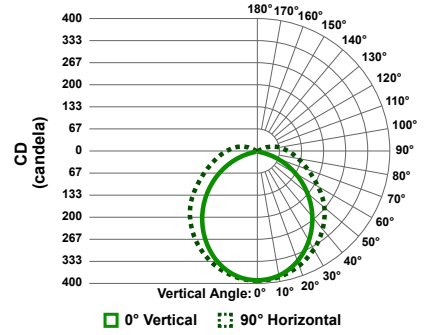
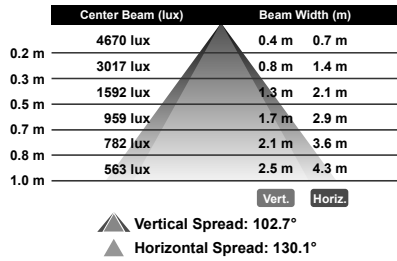
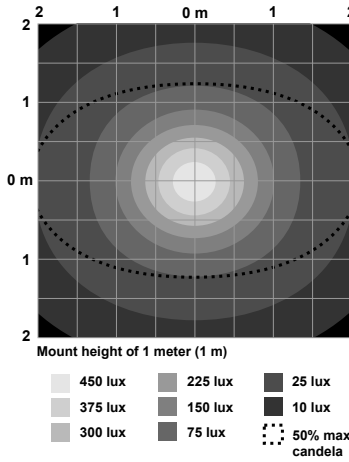

Figure 4. 570 mm Models

Illuminance at a Distance



Isolux Pattern



Polar Candela Distribution

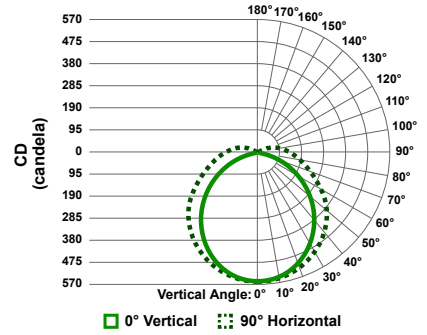
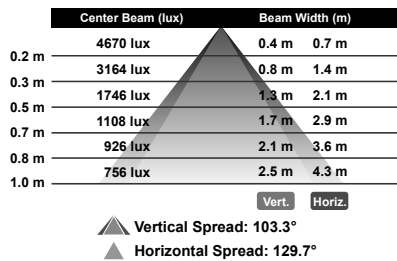
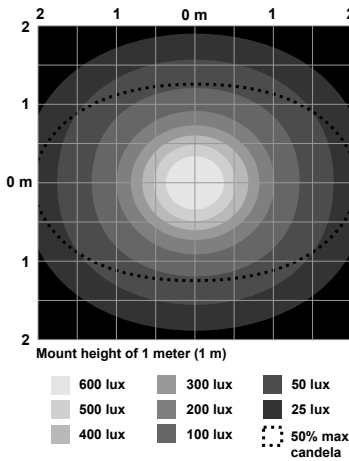

Figure 5. 850 mm Models

Illuminance at a Distance



Isolux Pattern



Polar Candela Distribution

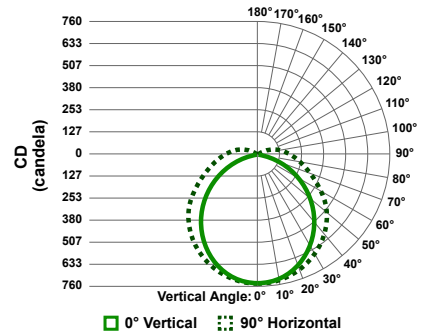

Figure 6. 1130 mm Models

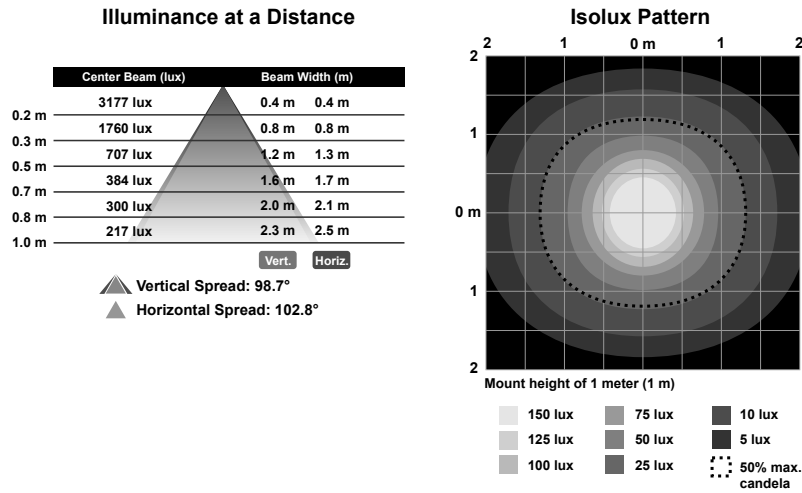

Figure 7. 285 mm Models with Eye Shields

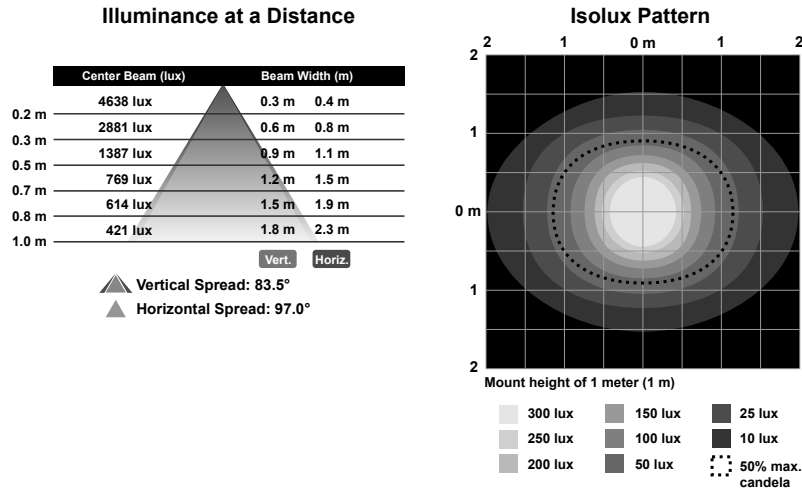
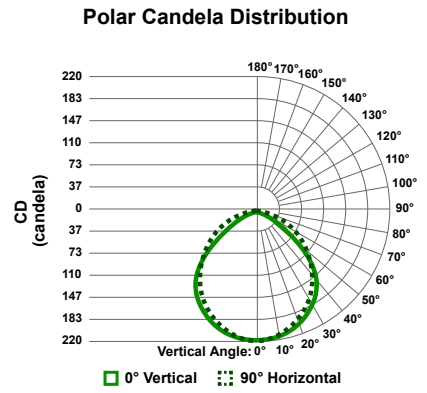

Figure 8. 570 mm Models with Eye Shields

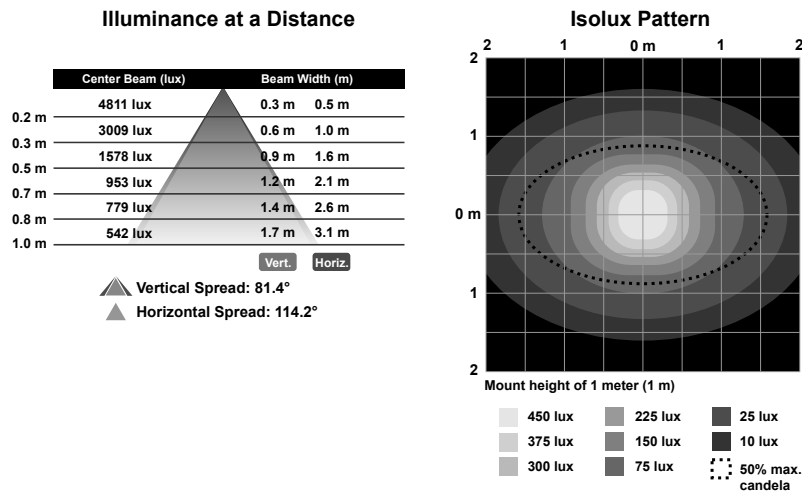
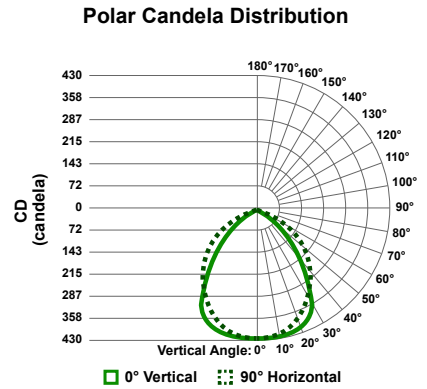

Figure 9. 850 mm Models with Eye Shields

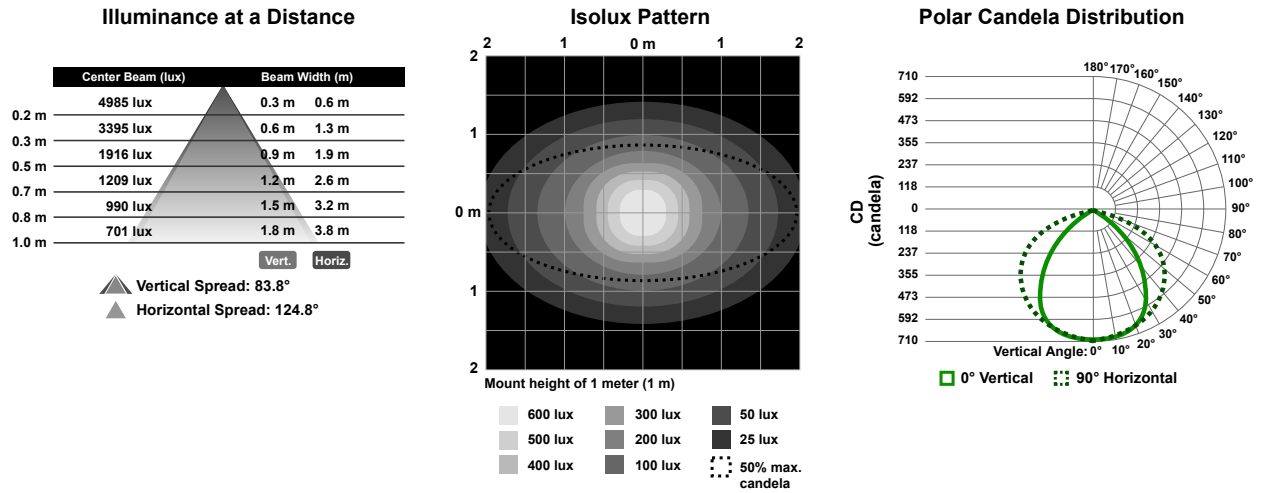
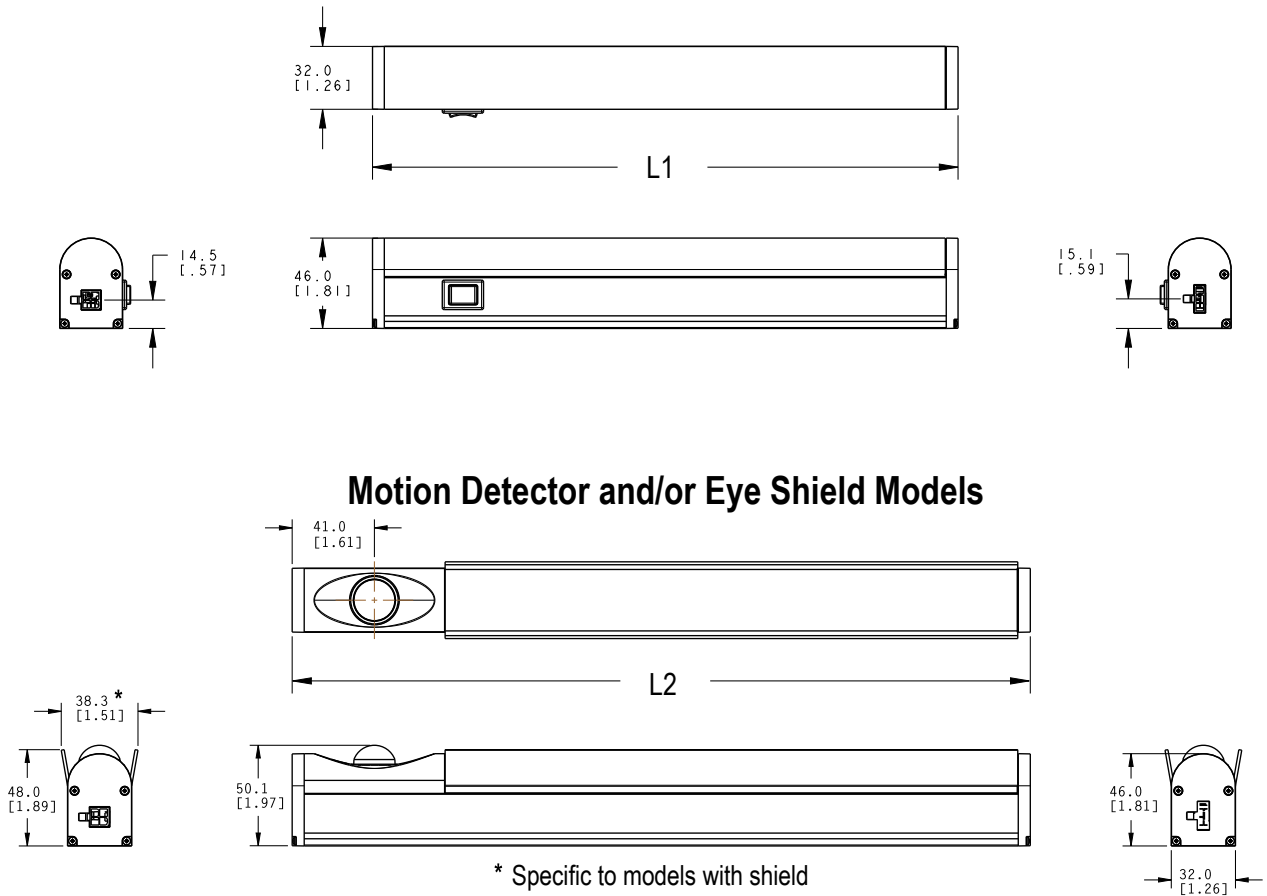

Figure 10. 1130 mm Models with Eye Shields

Dimensions



Model	Models without Motion Detector	Models with Motion Detector and/or Eye Shield
	L1	L2
WLB32ZC285..QM	298 mm (11.7 in)	368 mm (14.5 in)
WLB32ZC570..QM	580 mm (22.8 in)	650 mm (25.6 in)
WLB32ZC850..QM	862 mm (33.9 in)	932 mm (36.7 in)

Model	Models without Motion Detector	Models with Motion Detector and/or Eye Shield
	L1	L2
WLB32ZC1130..QM	1144 mm (45.0 in)	1214 mm (47.8 in)

Accessories

Wall Plug Cordsets				
Model	Plug Type	Countries	Length	Dimensions
LQMAC-306	Flying Leads		1.8 m (6 ft)	
LQMAC-306B	NEMA 5-15 grounded (IEC Type B)	United States, Canada, Japan, Puerto Rico, Taiwan		
LQMAC-306D	BS 546 (IEC Type D)	India		
LQMAC-306EF	CEE 7/7 (IEC Type E or F)	Germany, France, South Korea, The Netherlands, Poland, Spain, Turkey		
LQMAC-306G	BS 1363 (IEC Type G)	United Kingdom, Ireland, Singapore, Vietnam		
LQMAC-306I	AS/NZS 3112 (IEC Type I)	China, Australia, New Zealand		
LQMAC-306N	NBR 14136 (IEC Type N)	Brazil	3 m (10 ft)	
LQMAC-310B	NEMA 5-15 grounded (IEC Type B)	United States, Canada, Japan, Puerto Rico, Taiwan		

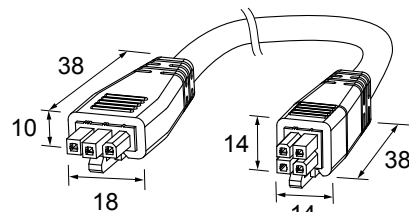
Continuous Run/Cascade Cordsets			
Model	Length	Style	Dimensions
LQMAEC-3005SS	0.15 m (0.5 ft)	Male straight/Male straight	
LQMAEC-301SS	0.31 m (1 ft)		
LQMAEC-303SS	0.91 m (3 ft)		
LQMAEC-306SS	1.83 m (6 ft)		
LQMAEC-312SS	3.66 m (12 ft)		
LQMAEC-320SS	6.1 m (20 ft)		
LQMAEC-330SS	9.14 m (30 ft)		

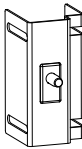
Enclosure Accessories	
<p>LMBEDS Switch</p> <ul style="list-style-type: none"> Bracket with plunger switch to power lights when the enclosure is opened Refer to datasheet 160672 for more information 	

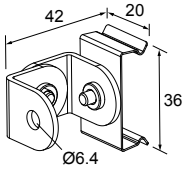
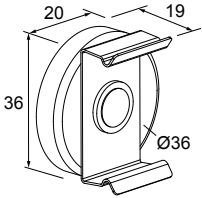
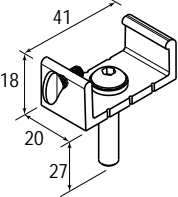
Mounting Brackets	
<p>LMBWLB32</p> <ul style="list-style-type: none"> • Replaces the bracket that ships with the WLB32 light • Stainless steel • Includes 4 snap clips, 4 screws, and 2 insulator caps 	<p>LMBWLB32-180S</p> <ul style="list-style-type: none"> • Swivel bracket kit allows 180° of movement 
<p>LMBWLB32MAG</p> <ul style="list-style-type: none"> • Magnetic mounting bracket for easy attachment to steel and iron surfaces 	<p>LMBWLB32U</p> <ul style="list-style-type: none"> • Die cast bracket for rugged applications • Secured to light with included thumb screw • Clearance hole for 6 mm (1/4 in) button head screw 
<p>LMBWLB32UT</p> <ul style="list-style-type: none"> • Die cast bracket for rugged applications • Secured to light with included thumb screw • Integral 1/4-20 stud for mounting 	

Banner Engineering Corp. Limited Warranty

Banner Engineering Corp. warrants its products to be free from defects in material and workmanship for one year following the date of shipment. Banner Engineering Corp. will repair or replace, free of charge, any product of its manufacture which, at the time it is returned to the factory, is found to have been defective during the warranty period. This warranty does not cover damage or liability for misuse, abuse, or the improper application or installation of the Banner product.

THIS LIMITED WARRANTY IS EXCLUSIVE AND IN LIEU OF ALL OTHER WARRANTIES WHETHER EXPRESS OR IMPLIED (INCLUDING, WITHOUT LIMITATION, ANY WARRANTY OF MERCHANTABILITY OR FITNESS FOR A PARTICULAR PURPOSE), AND WHETHER ARISING UNDER COURSE OF PERFORMANCE, COURSE OF DEALING OR TRADE USAGE.

This Warranty is exclusive and limited to repair or, at the discretion of Banner Engineering Corp., replacement. IN NO EVENT SHALL BANNER ENGINEERING CORP. BE LIABLE TO BUYER OR ANY OTHER PERSON OR ENTITY FOR ANY EXTRA COSTS, EXPENSES, LOSSES, LOSS OF PROFITS, OR ANY INCIDENTAL, CONSEQUENTIAL OR SPECIAL DAMAGES RESULTING FROM ANY PRODUCT DEFECT OR FROM THE USE OR INABILITY TO USE THE PRODUCT, WHETHER ARISING IN CONTRACT OR WARRANTY, STATUTE, TORT, STRICT LIABILITY, NEGLIGENCE, OR OTHERWISE.

Banner Engineering Corp. reserves the right to change, modify or improve the design of the product without assuming any obligations or liabilities relating to any product previously manufactured by Banner Engineering Corp.

Copyright Notice

Any misuse, abuse, or improper application or installation of this product or use of the product for personal protection applications when the product is identified as not intended for such purposes will void the product warranty. Any modifications to this product without prior express approval by Banner Engineering Corp will void the product warranties. All specifications published in this document are subject to change: Banner reserves the right to modify product specifications or update documentation at any time. For the most recent version of any documentation, refer to: www.bannerengineering.com. © Banner Engineering Corp. All rights reserved.