

Quick Start Guide

Self-Contained, Photoelectric Sensors in Universal-Style Housing



For complete technical information about this product, including installation instructions, application requirements and guidelines, EU Declaration of Conformity, technical specifications, and accessories, see www.bannerengineering.com and search 119166.



WARNING: Not To Be Used for Personnel Protection

Never use this device as a sensing device for personnel protection. Doing so could lead to serious injury or death. This device does not include the self-checking redundant circuitry necessary to allow its use in personnel safety applications. A sensor failure or malfunction can cause either an energized or de-energized sensor output condition.

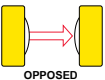
Models

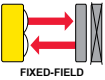
| Sensing Mode | Model | Range | LED | Output |
|----------------------------------------------------------------------------------------------------|-------------------|--------------------------|----------------------------------------------------|--------|
|  OPPOSED | QS303E Emitter | 60 m (200 ft) | Infrared, 875 nm Effective Beam: 18 mm (0.7 in) | - |
| | QS30VR3R Receiver | 60 m (200 ft) | - | |
|  POLAR RETRO | QS30VR3LP | 8 m (26 ft) ² | Visible red, 630 nm | SPDT |
|  FIXED-FIELD | QS30VR3FF200 | 200 mm (7.9 in) | Visible red, 680 nm | |
| | QS30VR3FF400 | 400 mm (15.7 in) | | |
| | QS30VR3FF600 | 600 mm (23.6 in) | | |

Wiring Diagrams

Cabled Emitters

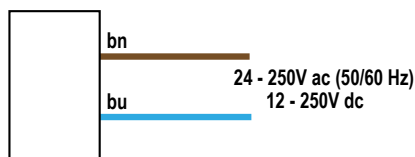

Other Cabled Models

Cable and OPMA hookups are functionally identical.

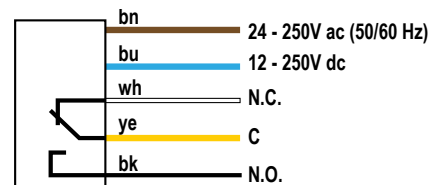

¹ Standard 2 m (6.5 ft) cable models are listed.

- For 9 m (30 ft) integral cable: add suffix "W/30" (for example, QS303E W/30).
- 5-pin Micro-style 152 mm (6 in) cable: add "OPMA" (for example, QS303EQPMA).

² Range is measured using a model BRT-84 retroreflector.



Specifications

Supply Voltage

Universal Voltage: 24 V to 250 V ac (50 Hz/60 Hz) or 12 V to 250 V dc (1.0 watt maximum)

Supply Protection Circuitry

Protected against transient voltages

Output Configuration

SPDT (Single-Pole Double-Throw) electromechanical relay output (all models except emitters)

Output Rating

Max. Switching Power (resistive load): 150 W, 1250 VA
 Max. Switching Voltage (resistive load): 250 V ac; 125 V dc
 Max. Switching Current (resistive load): 5 A at 250 V ac; 5 A at 30 V dc derated to 200 mA at 125 V dc
 Min. Voltage and Current: 5 V dc, 10 mA
 Mechanical life of relay: 50 million operations
 Electrical life of relay at full resistive load: 100,000 operations

Output Response

15 milliseconds ON and OFF



NOTE: 100 millisecond delay on power-up; output does not conduct during this time.

Cutoff Point Tolerance

Fixed-Field Only: ± 5% of nominal cutoff distance

Indicators

Two LEDs (Green and Amber) on top of sensor

Green ON: power to sensors is ON

Amber ON: light sensed

Amber flashing: excess gain marginal (1 to 1.5 times) in light condition

Large, oval LED indicator on sensor back (except emitters)

Amber ON: normally open output is conducting

Construction

ABS housing, rated IEC IP67, NEMA 6; acrylic lens cover

Connections

2 m (6.5 in) or 9 m (30 in) 5-wire PVC cable

Operating Conditions

-20 °C to +70 °C (-4 °F to +158 °F)

95% at +50 °C maximum relative humidity (non-condensing)

Required Overcurrent Protection



WARNING: Electrical connections must be made by qualified personnel in accordance with local and national electrical codes and regulations.

Overcurrent protection is required to be provided by end product application per the supplied table.

Overcurrent protection may be provided with external fusing or via Current Limiting, Class 2 Power Supply.

Supply wiring leads < 24 AWG shall not be spliced.

For additional product support, go to www.bannerengineering.com.

| Supply Wiring (AWG) | Required Overcurrent Protection (Amps) |
|---------------------|----------------------------------------|
| 20 | 5.0 |
| 22 | 3.0 |
| 24 | 2.0 |
| 26 | 1.0 |
| 28 | 0.8 |
| 30 | 0.5 |

Certifications



Dimensions

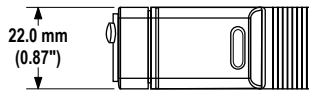

Hardware included:
(2) M3 x 0.5 x 28 stainless steel
machine screws, nuts and washers

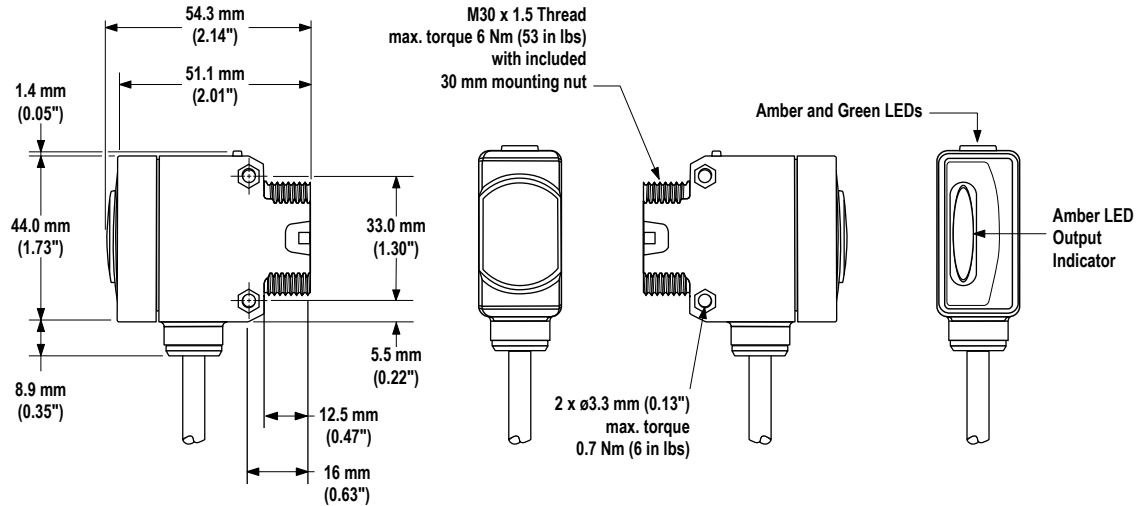

Banner Engineering Corp. Limited Warranty

Banner Engineering Corp. warrants its products to be free from defects in material and workmanship for one year following the date of shipment. Banner Engineering Corp. will repair or replace, free of charge, any product of its manufacture which, at the time it is returned to the factory, is found to have been defective during the warranty period. This warranty does not cover damage or liability for misuse, abuse, or the improper application or installation of the Banner product.

THIS LIMITED WARRANTY IS EXCLUSIVE AND IN LIEU OF ALL OTHER WARRANTIES WHETHER EXPRESS OR IMPLIED (INCLUDING, WITHOUT LIMITATION, ANY WARRANTY OF MERCHANTABILITY OR FITNESS FOR A PARTICULAR PURPOSE), AND WHETHER ARISING UNDER COURSE OF PERFORMANCE, COURSE OF DEALING OR TRADE USAGE.

This Warranty is exclusive and limited to repair or, at the discretion of Banner Engineering Corp., replacement. IN NO EVENT SHALL BANNER ENGINEERING CORP. BE LIABLE TO BUYER OR ANY OTHER PERSON OR ENTITY FOR ANY EXTRA COSTS, EXPENSES, LOSSES, LOSS OF PROFITS, OR ANY INCIDENTAL, CONSEQUENTIAL OR SPECIAL DAMAGES RESULTING FROM ANY PRODUCT DEFECT OR FROM THE USE OR INABILITY TO USE THE PRODUCT, WHETHER ARISING IN CONTRACT OR WARRANTY, STATUTE, TORT, STRICT LIABILITY, NEGLIGENCE, OR OTHERWISE.

Banner Engineering Corp. reserves the right to change, modify or improve the design of the product without assuming any obligations or liabilities relating to any product previously manufactured by Banner Engineering Corp. Any misuse, abuse, or improper application or installation of this product or use of the product for personal protection applications when the product is identified as not intended for such purposes will void the product warranty. Any modifications to this product without prior express approval by Banner Engineering Corp will void the product warranties. All specifications published in this document are subject to change; Banner reserves the right to modify product specifications or update documentation at any time. Specifications and product information in English supersede that which is provided in any other language. For the most recent version of any documentation, refer to: www.bannerengineering.com.