

Shock-Safe Fuseholder, 5 x 20 mm, Slotted Cap/Fingergrip, Snap stepless, 1.0 - 3.0 mm, IEC 60335-1



Snap-in version  
 from front side  
 horizontal with finger grip  
 fingergrip

250 VAC · 2.5W/10A (VDE) · 500V · 16A (UL/CSA)

See below:  
[Approvals and Compliances](#)

### Description

- Panel Thickness 1.0 - 3.0 mm, Snap stepless
- Compact design
- White color available on request

### Applications

- Household appliances
- Medical equipment

### Weblinks

[pdf data sheet](#), [html data sheet](#), [General Product Information](#), [Packaging details](#), [Distributor-Stock-Check](#), [Detailed request for product](#), [Microsite](#)

### Technical Data

Shock-Safe Category	PC2
Fuse-Link	5 x 20 mm
Mounting	Panel mount, Front Side
Attachment	Snap-in
Terminal	Solder or Quick-Connect 4.8 x 0.5 mm
Rated Voltage	250 VAC , 500V (UL/CSA)
Rated current	10A (VDE), 16A (UL/CSA)
Rated Power Acceptance IEC	2.5W / 10A @ Ta 23 °C
Degree of Protection	IP 40
Protection Class	Suitable for appliances with protection class I acc. to IEC 61140
Admissible Ambient Air Temp.	-40 °C to 85 °C
Climatic Category	40/085/21 acc. to IEC 60068-1
Material: Socket	Thermoplastic, black, UL 94V-0
Material: Terminals	Tin-Plated Copper Alloy
Unit Weight	5.3 g
Storage Conditions	0 °C to 60 °C, max. 70% r.h.
Product Marking	 Type, Rated Voltage, Power Acc./Current Rating, Panel Thickness, Certification marks

Soldering Methods	Iron <a href="#">Soldering Profile</a>
Solderability	350 °C / 2 sec acc. to IEC 60068-2-20, Test Ta, method 2
Resistance to Soldering Heat	350 °C / 10 sec acc. to IEC 60068-2-20, Test Tb, method 2
Contact Resistance	≤ 10 mΩ at 100 mA acc. to IEC 60127-6
Dielectric Strength	> 3kV > 4kV between L/N-PE (50Hz: 1 min)
Impulse Withstand Voltage	> 2.5kV between L-N > 6kV between L/N-PE
Insulation Resistance	> 10 MΩ between L-N > 100 MΩ between L/N-PE (500VDC: 1 min)
Overvoltage Category	III acc. to IEC 60664-1
Pollution Degree	3 acc. to IEC 60664-1
Resistance to Vibration	acc. to IEC 60068-2-6, test Fc
Panel Thickness	1.0 - 3.0 mm

### Approvals and Compliances



Detailed information on product approvals, code requirements, usage instructions and detailed test conditions can be looked up in [Details about Approvals](#)

SCHURTER products are designed for use in industrial environments. They have approvals from independent testing bodies according to national and international standards. Products with specific characteristics and requirements such as required in the automotive sector according to IATF 16949, medical technology according to ISO 13485 or in the aerospace industry can be offered exclusively with customer-specific, individual agreements by SCHURTER.

### Approvals

The approval mark is used by the testing authorities to certify compliance with the safety requirements placed on electronic products.

Approval Reference Type: FPG3

Approval Logo	Certificates	Certification Body	Description
	<a href="#">VDE Approvals</a>	VDE	VDE Certificate Number: 127216
	<a href="#">UL Approvals</a>	UL	UL File Number: E39328
	<a href="#">KTL Approvals</a>	KTL	Korea Testing Laboratory



**Product standards**

Product standards that are referenced

Organization	Design	Standard	Description
	Designed according to	IEC 60127-6	Miniature fuses. Part 6. Fuse-holders for miniature fuse-links
	Designed according to	UL 4248-1	Fuseholder general requirements
	Designed according to	CSA C22.2 no. 4248.1	Fuseholder general requirements





**Application standards**

Application standards where the product can be used

Organization	Design	Standard	Description
	Designed for applications acc.	IEC/UL 60950	IEC 60950-1 includes the basic requirements for the safety of information technology equipment.
	Designed for applications acc.	IEC 60335-1	Safety of electrical appliances for household and similar purposes. Meets the requirements for appliances in unattended use. This includes the enhanced requirements of glow wire tests acc. to IEC 60695-2-11 or -12 & -13.

**Compliances**

The product complies with following Guide Lines

Identification	Details	Initiator	Description
	<a href="#">CE declaration of conformity</a>	SCHURTER AG	The CE marking declares that the product complies with the applicable requirements laid down in the harmonisation of Community legislation on its affixing in accordance with EU Regulation 765/2008.
	RoHS	SCHURTER AG	EU Directive RoHS 2011/65/EU
	China RoHS	SCHURTER AG	The law SJ / T 11363-2006 (China RoHS) has been in force since 1 March 2007. It is similar to the EU directive RoHS.
	REACH	SCHURTER AG	On 1 June 2007, Regulation (EC) No 1907/2006 on the Registration, Evaluation, Authorization and Restriction of Chemicals 1 (abbreviated as "REACH") entered into force.
	White paper Glow wire test	SCHURTER AG	Meets the requirements of IEC 60335-1 for appliances in unattended use. This includes the enhanced requirements of glow wire tests acc. to IEC 60695-2-11 or -12 & -13.

**Dimension [mm]**

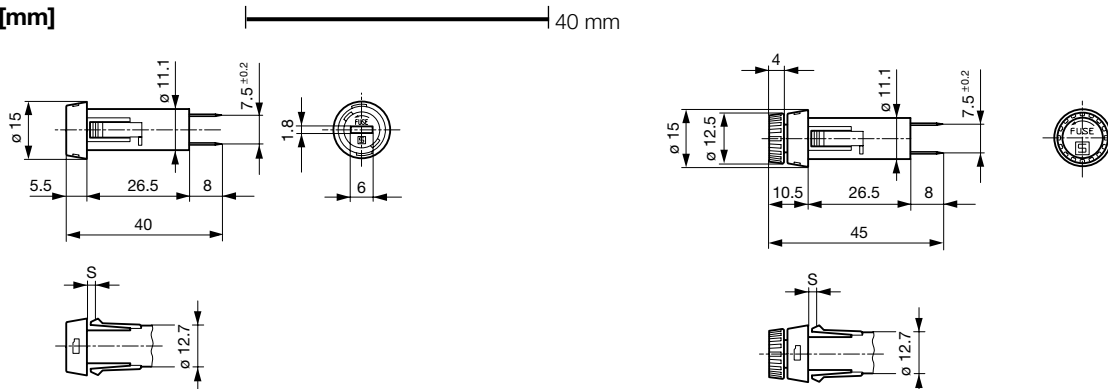

Variants 3101.0030, 3101.0230, 3101.0031 and 3101.0331  
 s = Panel thickness (see variants)

Variants Fingergrrip 3101.0035, 3101.0235, 3101.0036 and 3101.0336  
 s = Panel thickness (see variants)

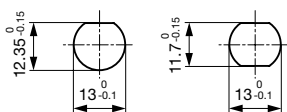

Mounting holes

### Derating Curves

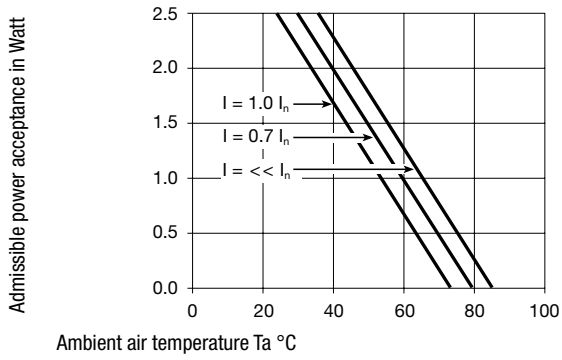

### All Variants

Holder	Cap	Panel Thickness s [mm]	Terminal	Colour Holder	Material	Order Number
●	slotted	1.0 - 1.8mm	Solder	black	Thermoplastic	3101.0030
●	slotted	1.0 - 1.8mm	Quick-Connect 4.8 x 0.5 mm	black	Thermoplastic	3101.0230
●	slotted	2.0 - 3.0mm	Solder	black	Thermoplastic	3101.0031
●	slotted	2.0 - 3.0mm	Quick-Connect 4.8 x 0.5 mm	black	Thermoplastic	3101.0331
●	Fingergrip	1.0 - 1.8mm	Solder	black	Thermoplastic	3101.0035
●	Fingergrip	1.0 - 1.8mm	Quick-Connect 4.8 x 0.5 mm	black	Thermoplastic	3101.0235
●	Fingergrip	2.0 - 3.0mm	Solder	black	Thermoplastic	3101.0036
●	Fingergrip	2.0 - 3.0mm	Quick-Connect 4.8 x 0.5 mm	black	Thermoplastic	3101.0336

Most Popular.

Availability for all products can be searched real-time: <https://www.schurter.com/en/Stock-Check/Stock-Check-SCHURTER>

**Packaging Unit** Bulk 186 x 91 x 91 mm (100 pcs.)