

# Data interface - SI-RND-U1A - 1425185

Please be informed that the data shown in this PDF Document is generated from our Online Catalog. Please find the complete data in the user's documentation. Our General Terms of Use for Downloads are valid (<http://phoenixcontact.com/download>)

Service socket with USB A 3.0 (socket/socket), with protective cover



## Key Commercial Data

Packing unit	1 pc
GTIN	 4 055626 386713
GTIN	4055626386713

## Technical data

### Mechanical characteristics

Number of positions	4
Connection profile	USB-A
Insertion/withdrawal cycles	≥ 1500

### Ambient conditions

Ambient temperature (operation)	-40 °C ... 70 °C
Degree of protection	IP65 (with closed protective cover)

### Material data

Flammability rating according to UL 94	V0
Housing material	PA
Contact material	Copper alloy
Contact surface material	gold-plated
Height	42.7 mm

### Electrical characteristics

Number of positions	4
Transmission speed	USB 3.0 (socket/socket) type: A

## Standards and Regulations

# Data interface - SI-RND-U1A - 1425185

## Technical data

### Standards and Regulations

Flammability rating according to UL 94	V0
--	----

### Environmental Product Compliance

China RoHS	Environmentally Friendly Use Period = 50
	For details about hazardous substances go to tab "Downloads", Category "Manufacturer's declaration"

## Drawings

Dimensional drawing

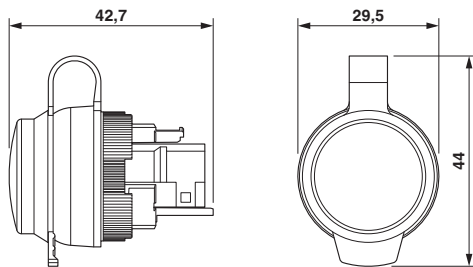

Dimensional drawing

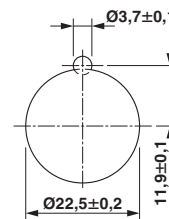

Mounting cutout

Dimensional drawing

Schematic diagram

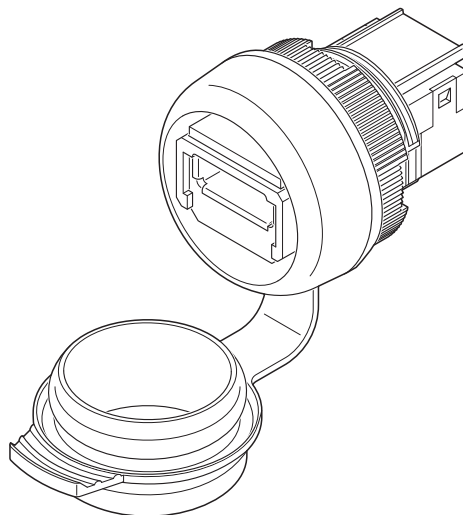

Schematic drawing 1

## Approvals

Approvals

# Data interface - SI-RND-U1A - 1425185

## Approvals

Approvals





UL Listed / cUL Listed / EAC / cULus Listed

---

Ex Approvals

---

### Approval details

UL Listed		<a href="http://database.ul.com/cgi-bin/XYV/template/LISEXT/1FRAME/index.htm">http://database.ul.com/cgi-bin/XYV/template/LISEXT/1FRAME/index.htm</a>	FILE E 335024
cUL Listed		<a href="http://database.ul.com/cgi-bin/XYV/template/LISEXT/1FRAME/index.htm">http://database.ul.com/cgi-bin/XYV/template/LISEXT/1FRAME/index.htm</a>	FILE E 335024
EAC			RU C- DE.AI30.B.01102
cULus Listed			

---

Phoenix Contact 2019 © - all rights reserved  
<http://www.phoenixcontact.com>

PHOENIX CONTACT GmbH & Co. KG  
Flachsmarktstr. 8  
32825 Blomberg  
Germany  
Tel. +49 5235 300  
Fax +49 5235 3 41200  
<http://www.phoenixcontact.com>