

# EZ-LIGHT® Touch Gen 2 K30 FDA-Grade Illuminated Buttons

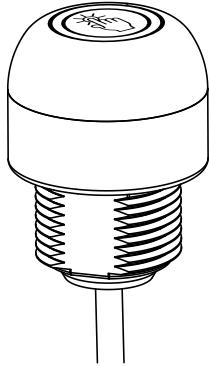

## Datasheet

Lighted touch button with bipolar outputs



- FDA-grade materials; rated to IEC IP67, IP68, and IP69K
- Laser marked information withstands aggressive cleaning procedures
- Excellent immunity to false triggering by water spray, detergents, oils, and other foreign materials
- Rugged, cost-effective, and easy-to-install touch button with multicolor light
- Momentary versions remain activated as long as touch is present
- Latching versions start up not activated and toggle between activated and not activated on successive touches
- Ergonomically designed to eliminate hand, wrist, and arm stresses associated with repeated switch operation; require no physical force to operate
- Can be actuated with bare hands or in gloves
- 12 to 30 V dc operation

## Models

Model <sup>1</sup>	Function	Output	Light (not activated)	Light (activated)	Connection	
K30ALBT2FXGHQP	Latching	Bipolar, N.O.	-	Green	150 mm (6 in) pigtail PVC cable with a 5-pin M12/Euro-style male, stainless steel, quick disconnect (QD)	
K30RLBT2FXGHQP		Bipolar, N.C.				
K30ABT2FXGHQP	Momentary	Bipolar, N.O.				
K30RBT2FXGHQP		Bipolar, N.C.				
K30ALBT2FGGHQP	Latching	Bipolar, N.O.		Green		Green
K30RLBT2FGGHQP		Bipolar, N.C.				
K30ABT2FGGHQP	Momentary	Bipolar, N.O.				
K30RBT2FGGHQP		Bipolar, N.C.				
K30ALBT2FRGHQP	Latching	Bipolar, N.O.	Red			Green
K30RLBT2FRGHQP		Bipolar, N.C.				
K30ABT2FRGHQP	Momentary	Bipolar, N.O.				
K30RBT2FRGHQP		Bipolar, N.C.				

## Specifications

Supply Voltage  
12 to 30 V dc

Supply Current  
55 mA max current (exclusive of load)

Supply Protection Circuitry  
Protected against reverse polarity and transient voltages

Power-Up Delay  
300 milliseconds  
Latching models start up in a 'not activated' state

Output Rating

Maximum Load: 150 mA  
ON-state saturation voltage: < 2 V at 10 mA dc; < 2.5 V at 150 mA dc  
OFF-state leakage current: < 10 µA at 30 V dc

Output Response Time

150 milliseconds ON and OFF

<sup>1</sup> To order the 2 m (6.5 ft) cable models, omit suffix QP from model number (example, K30ALBT2FXGH). A model with a QD requires a mating cable (see [Cordsets](#) on page 3).



**Connections**

2 m (6.5 ft) PVC integral cable, or 150 mm (6 in) pigtail PVC cable with a 5-pin M12/Euro-style male, stainless steel, quick disconnect (QD)

**Environmental Rating**

IEC IP67, IP69K per DIN 40050-9.

**Operating Conditions**

-40 °C to +50 °C (-40 °F to +122 °F)  
90% at 50 °C maximum relative humidity (non-condensing)

**Storage**

-40 °C to +70 °C (-40 °F to +158 °F)

**Vibration and Mechanical Shock**

Vibration 10 Hz to 55 Hz 1.0 mm p-p amplitude per IEC 60068-2-6  
Shock 30G 11 ms duration, half sine wave per IEC 60068-2-27

**Certifications**



**Construction**

Base, dome, and nut: FDA-grade polycarbonate

**Mounting**

M22 × 1.5 Threaded base, max torque 2.25 Nm (20 in-lbf)

**Required Overcurrent Protection**



**WARNING:** Electrical connections must be made by qualified personnel in accordance with local and national electrical codes and regulations.

Overcurrent protection is required to be provided by end product application per the supplied table.

Overcurrent protection may be provided with external fusing or via Current Limiting, Class 2 Power Supply.

Supply wiring leads < 24 AWG shall not be spliced.

For additional product support, go to <http://www.bannerengineering.com>.

Supply Wiring (AWG)	Required Overcurrent Protection (Amps)
20	5.0
22	3.0
24	2.0
26	1.0
28	0.8
30	0.5

**Dimensions**

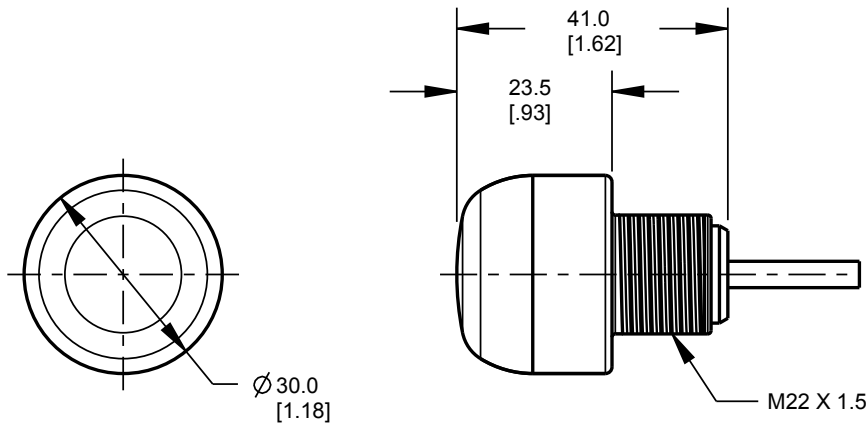

**Wiring Diagram**

Bipolar

Color Key

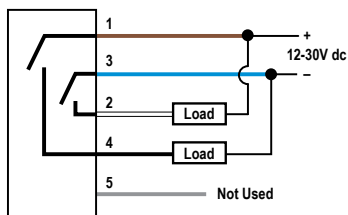

- 1 = Brown
- 2 = White
- 3 = Blue
- 4 = Black
- 5 = Gray

Cabled wiring diagrams are shown. Quick disconnect (QD) wiring diagrams are functionally identical.

## Accessories

### Cordsets

5-Pin Threaded M12/Euro-Style Cordsets—Single Ended				
Model	Length	Style	Dimensions	Pinout (Female)
MQDC1-501.5	0.50 m (1.5 ft)	Straight		<p>1 = Brown 2 = White 3 = Blue 4 = Black 5 = Gray</p>
MQDC1-506	1.83 m (6 ft)			
MQDC1-515	4.57 m (15 ft)			
MQDC1-530	9.14 m (30 ft)			
MQDC1-506RA	1.83 m (6 ft)	Right-Angle		
MQDC1-515RA	4.57 m (15 ft)			
MQDC1-530RA	9.14 m (30 ft)			

5-Pin Threaded M12/Euro-Style Cordsets—Washdown Stainless Steel				
Model	Length	Style	Dimensions	Pinout (Female)
MQDC-WDSS-0506	1.83 m (6 ft)	Straight		<p>1 = Brown 2 = White 3 = Blue 4 = Black 5 = Gray</p>
MQDC-WDSS-0515	4.57 m (15 ft)			
MQDC-WDSS-0530	9.14 m (30 ft)			

5-Pin Threaded M12/Euro-Style Cordsets—Washdown, with Shield				
Model	Length	Style	Dimensions	Pinout (Female)
MQDCWD-506	1.83 m (6 ft)	Straight		<p>1 = Brown 2 = White 3 = Blue 4 = Black 5 = Gray</p>
MQDCWD-530	9.14 m (30 ft)			

## Brackets

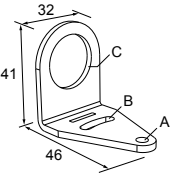
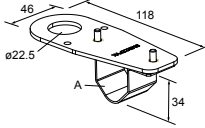
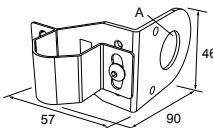
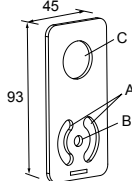
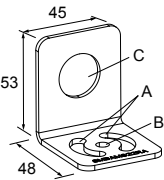
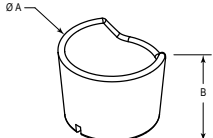
<p><b>SMB22A</b></p> <ul style="list-style-type: none"> <li>Right-angle bracket with curved slot for versatile orientation</li> <li>12-ga. stainless steel</li> <li>Mounting hole for 22 mm sensor</li> </ul>  <p>Hole center spacing: A to B = 26.0 Hole size: A = <math>\varnothing</math> 4.6, B = 4.6 x 16.9, C = 22.2</p>	<p><b>SMB22FVK</b></p> <ul style="list-style-type: none"> <li>V-clamp, flat bracket and fasteners for mounting to pipe or extensions</li> <li>Clamp accommodates 28 mm diameter tubing or 1 in. square extrusions</li> <li>22 mm hole for mounting sensor</li> </ul>  <p>Hole size: A = <math>\varnothing</math> 22.5</p>
<p><b>SMB22RAVK</b></p> <ul style="list-style-type: none"> <li>V-clamp, right-angle bracket and fasteners for mounting to pipe or extensions</li> <li>Clamp accommodates 28 mm diameter tubing or 1 in. square extrusions</li> <li>22 mm hole for mounting sensor</li> </ul>  <p>Hole size: A = <math>\varnothing</math> 22.5</p>	<p><b>SMBAMS22P</b></p> <ul style="list-style-type: none"> <li>Flat SMBAMS series bracket with 22 mm hole for mounting sensors</li> <li>Articulation slots for 90+° rotation</li> <li>12-ga. (2.6 mm) cold-rolled steel</li> </ul>  <p>Hole center spacing: A = 26.0, A to B = 13.0 Hole size: A = 26.8 x 7.0, B = <math>\varnothing</math> 6.5, C = <math>\varnothing</math> 22.5</p>
<p><b>SMBAMS22RA</b></p> <ul style="list-style-type: none"> <li>Right-angle SMBAMS series bracket with 22 mm hole for mounting sensors</li> <li>Articulation slots for 90+° rotation</li> <li>12-ga. (2.6 mm) cold-rolled steel</li> </ul>  <p>Hole center spacing: A = 26.0, A to B = 13.0 Hole size: A = 26.8 x 7.0, B = <math>\varnothing</math> 6.5, C = <math>\varnothing</math> 22.5</p>	<p><b>TC-K30-CL</b></p> <ul style="list-style-type: none"> <li>Touch cover</li> </ul>  <p>Diameter: A = 40.7 Height: B = 31</p>

All measurements are listed in millimeters, unless noted otherwise.

## Banner Engineering Corp. Limited Warranty

Banner Engineering Corp. warrants its products to be free from defects in material and workmanship for one year following the date of shipment. Banner Engineering Corp. will repair or replace, free of charge, any product of its manufacture which, at the time it is returned to the factory, is found to have been defective during the warranty period. This warranty does not cover damage or liability for misuse, abuse, or the improper application or installation of the Banner product.

THIS LIMITED WARRANTY IS EXCLUSIVE AND IN LIEU OF ALL OTHER WARRANTIES WHETHER EXPRESS OR IMPLIED (INCLUDING, WITHOUT LIMITATION, ANY WARRANTY OF MERCHANTABILITY OR FITNESS FOR A PARTICULAR PURPOSE), AND WHETHER ARISING UNDER COURSE OF PERFORMANCE, COURSE OF DEALING OR TRADE USAGE.

This Warranty is exclusive and limited to repair or, at the discretion of Banner Engineering Corp., replacement. IN NO EVENT SHALL BANNER ENGINEERING CORP. BE LIABLE TO BUYER OR ANY OTHER PERSON OR ENTITY FOR ANY EXTRA COSTS, EXPENSES, LOSSES, LOSS OF PROFITS, OR ANY INCIDENTAL, CONSEQUENTIAL OR SPECIAL DAMAGES RESULTING FROM ANY PRODUCT DEFECT OR FROM THE USE OR INABILITY TO USE THE PRODUCT, WHETHER ARISING IN CONTRACT OR WARRANTY, STATUTE, TORT, STRICT LIABILITY, NEGLIGENCE, OR OTHERWISE.

Banner Engineering Corp. reserves the right to change, modify or improve the design of the product without assuming any obligations or liabilities relating to any product previously manufactured by Banner Engineering Corp.