

Datasheet

Large one to five color indicator with flashing input control

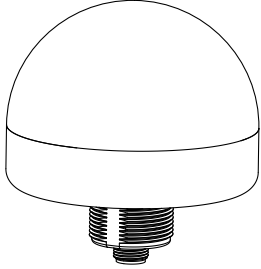

- Bright, uniform indicator light
- All models have flashing input control
- Models are available with up to five colors in one device
- Rugged IP67-rated design
- 12 to 30 V dc operation

Models

Model	No. of Colors	Colors	Input	Connection
K90LGPQ	1	Green	PNP	5-pin M12/Euro-style Quick Disconnect
K90LRPQ		Red		
K90LYPQ		Yellow		
K90LBPQ		Blue		
K90LWPQ		White		
K90LGNQ		Green	NPN	
K90LRNQ		Red		
K90LYNQ		Yellow		
K90LBNQ		Blue		
K90LWNQ		White		

Model	No. of Colors	Colors	Connection	Input
K90LGRPQ	2	Green, Red	5-pin M12/Euro-style Quick Disconnect	PNP
K90LGYRPQ	3	Green, Red, Yellow		
K90LBGYRPQ	4	Blue, Green, Yellow, Red	8-pin M12/Euro-style Quick Disconnect	
K90LWBGYRPQ	5	White, Blue, Green, Yellow, Red		
K90LGRNQ	2	Green, Red	5-pin M12/Euro-style Quick Disconnect	NPN
K90LGYRNQ	3	Green, Red, Yellow		
K90LBGYRNQ	4	Blue, Green, Yellow, Red	8-pin M12/Euro-style Quick Disconnect	
K90LWBGYRNQ	5	White, Blue, Green, Yellow, Red		

Integral quick disconnect models are listed; a mating cordset is required (see [Accessories](#) on page 4).

- To order the 150 mm (5.9 in) PVC pigtail with quick disconnect models, replace **Q** with **QP** in the model number, for example, K90LGYRQP.
- To order the 2 m (6.5 ft) cable modes, omit the suffix **Q** in the model number, for example, K90LGYR.



Specifications

Supply Voltage and Current

12 to 30 V dc
475 mA maximum at 12 V dc
175 mA maximum at 30 V dc

Supply Protection Circuitry

Protected against reverse polarity and transient voltages

Input Response Time

75 ms maximum

Adjustments

1.6 Hz flash rate via flash input wire

Connections

Integral 5-pin M12/Euro-style quick disconnect; Integral 8-pin M12/Euro-style quick disconnect; 150 mm (6 in) PVC cable with a 5-pin M12/Euro-style quick disconnect; 150 mm (6 in) PVC cable with a 8-pin M12/Euro-style quick disconnect; or 2 m (6.5 ft) unterminated PVC-jacketed cable depending on the model

Construction

Base and dome: Polycarbonate

Environmental Rating

IEC IP67; Enclosure UL Type 4X, 13

Vibration and Mechanical Shock

All models meet MIL-STD-202F, Method 201A (Vibration: 10 Hz to 60 Hz maximum, 0.06 inch (1.52 mm) double amplitude, 10G maximum acceleration) requirements. Also meets IEC 60947-5-2 (Shock: 30G 11 ms duration, half sine wave) requirements.

Operating Conditions

-40 °C to +50 °C (-40 °F to +122 °F)

Certifications



Light Characteristics

Color	Typical Wavelength or Color Temperature	Typical Intensity
Red	625 nm	65 lumens
Yellow	590 nm	35 lumens
Green	525 nm	150 lumens
Blue	470 nm	55 lumens
White	6000-7100 K	200 lumens

Indicators

1 to 5 colors, depending on the model
Only one color can be on at a time. The higher color number overrides the lower color number.

Required Overcurrent Protection



WARNING: Electrical connections must be made by qualified personnel in accordance with local and national electrical codes and regulations.

Overcurrent protection is required to be provided by end product application per the supplied table.
Overcurrent protection may be provided with external fusing or via Current Limiting, Class 2 Power Supply.
Supply wiring leads < 24 AWG shall not be spliced.
For additional product support, go to www.bannerengineering.com.

Supply Wiring (AWG)	Required Overcurrent Protection (Amps)
20	5.0
22	3.0
24	2.0
26	1.0
28	0.8
30	0.5

Dimensions

All measurements are listed in millimeters [inches], unless noted otherwise.

Models with Quick Disconnect

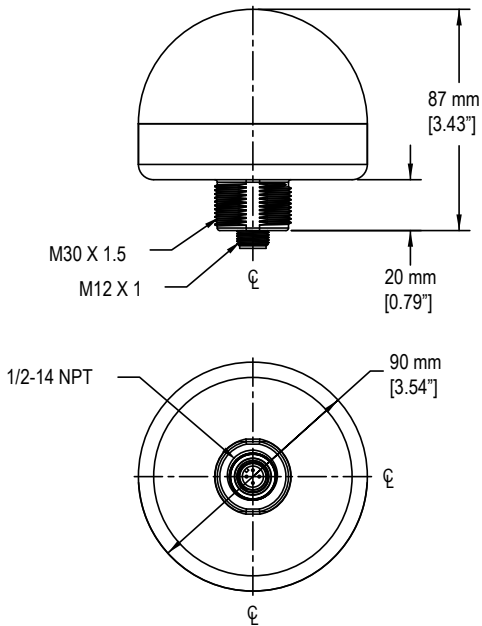

Models with Integral Cable

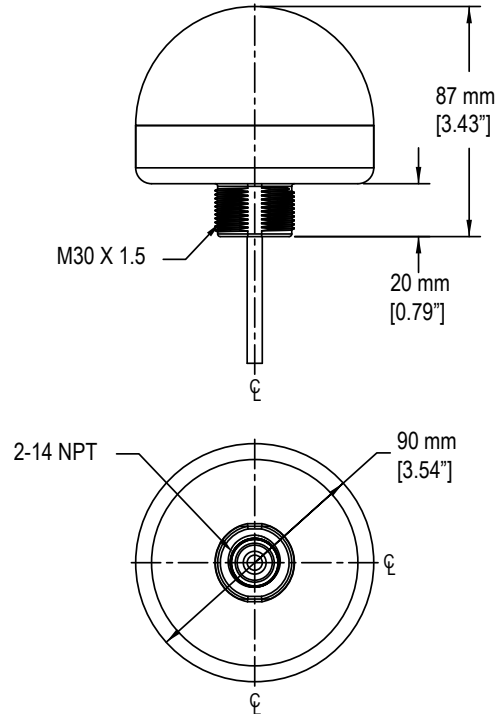

Wiring

5-pin PNP Input	5-Pin NPN Input	Key
		<p>1 = Brown 2 = White 3 = Blue 4 = Black 5 = Gray Gray wire (flashing input)</p>

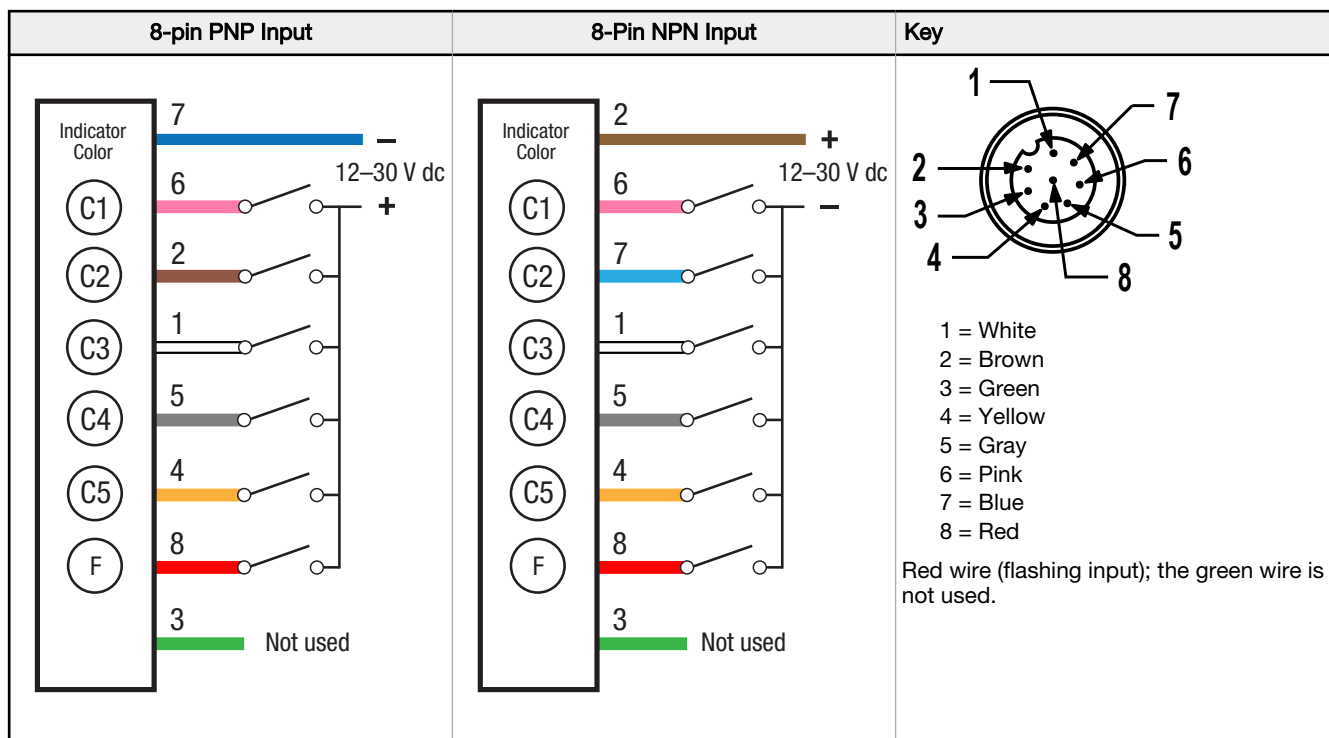



Accessories

Cordsets

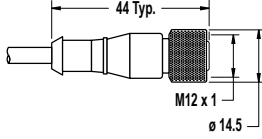
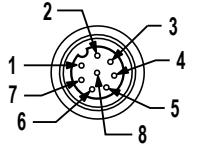
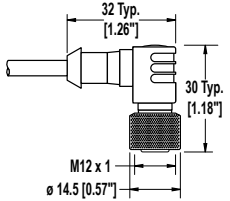
5-Pin Threaded M12/Euro-Style Cordsets—Single Ended				
Model	Length	Style	Dimensions	Pinout (Female)
MQDC1-501.5	0.50 m (1.5 ft)	Straight		<p> 1 = Brown 2 = White 3 = Blue 4 = Black 5 = Gray </p>
MQDC1-506	1.83 m (6 ft)			
MQDC1-515	4.57 m (15 ft)			
MQDC1-530	9.14 m (30 ft)	Right-Angle		
MQDC1-506RA	1.83 m (6 ft)			
MQDC1-515RA	4.57 m (15 ft)			
MQDC1-530RA	9.14 m (30 ft)			

8-Pin Threaded M12/Euro-Style Cordsets with Open-Shield				
Model	Length	Style	Dimensions	Pinout (Female)
MQDC2S-806	1.83 m (6 ft)	Straight		 <p>1 = White 2 = Brown 3 = Green 4 = Yellow 5 = Gray 6 = Pink 7 = Blue 8 = Red</p>
MQDC2S-815	4.57 m (15 ft)			
MQDC2S-830	9.14 m (30 ft)			
MQDC2S-850	15.2 m (50 ft)			
MQDC2S-806RA	1.83 m (6 ft)	Right-Angle		
MQDC2S-815RA	4.57 m (15 ft)			
MQDC2S-830RA	9.14 m (30 ft)			
MQDC2S-850RA	15.2 m (50 ft)			

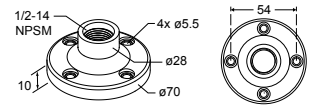

Elevated Mount System

Model	Features	Components												
SA-M30 - Black Polycarbonate	<ul style="list-style-type: none"> Streamlined black PC or Gray PC thread cover Covers M30 thread on the light base Mounting hardware included 													
SA-M30C - Gray Polycarbonate														
<table border="1"> <thead> <tr> <th>Polished 304 Stainless Steel</th> <th>Black Anodized Aluminum</th> <th>Clear Anodized Aluminum</th> </tr> </thead> <tbody> <tr> <td>SOP-E12-150SS 150 mm (6 in) long</td> <td>SOP-E12-150A 150 mm (6 in) long</td> <td>SOP-E12-150AC 150 mm (6 in) long</td> </tr> <tr> <td>SOP-E12-300SS 300 mm (12 in) long</td> <td>SOP-E12-300A 300 mm (12 in) long</td> <td>SOP-E12-300AC 300 mm (12 in) long</td> </tr> <tr> <td>SOP-E12-900SS 900 mm (36 in) long</td> <td>SOP-E12-900A 900 mm (36 in) long</td> <td>SOP-E12-900AC 900 mm (36 in) long</td> </tr> </tbody> </table>	Polished 304 Stainless Steel	Black Anodized Aluminum	Clear Anodized Aluminum	SOP-E12-150SS 150 mm (6 in) long	SOP-E12-150A 150 mm (6 in) long	SOP-E12-150AC 150 mm (6 in) long	SOP-E12-300SS 300 mm (12 in) long	SOP-E12-300A 300 mm (12 in) long	SOP-E12-300AC 300 mm (12 in) long	SOP-E12-900SS 900 mm (36 in) long	SOP-E12-900A 900 mm (36 in) long	SOP-E12-900AC 900 mm (36 in) long	<ul style="list-style-type: none"> Elevated-use stand-off pipe (½ in. NPSM/DN15) Polished 304 stainless steel, black anodized aluminum, or clear anodized aluminum surface ½ in. NPT thread at both ends Compatible with most industrial environments 	
Polished 304 Stainless Steel	Black Anodized Aluminum	Clear Anodized Aluminum												
SOP-E12-150SS 150 mm (6 in) long	SOP-E12-150A 150 mm (6 in) long	SOP-E12-150AC 150 mm (6 in) long												
SOP-E12-300SS 300 mm (12 in) long	SOP-E12-300A 300 mm (12 in) long	SOP-E12-300AC 300 mm (12 in) long												
SOP-E12-900SS 900 mm (36 in) long	SOP-E12-900A 900 mm (36 in) long	SOP-E12-900AC 900 mm (36 in) long												
SA-E12M30 - Black Acetal	<ul style="list-style-type: none"> Streamlined black acetal or white UHMW mounting base adapter/cover Connects between ½ in. NPSM/DN15 pipe and 30 mm (1-3/16 in) drilled hole Mounting hardware included 													
SA-E12M30C - White UHMW														

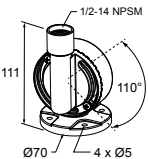
Pipe Mounting Flange			
Model	Features	Construction	
SA-F12	<ul style="list-style-type: none"> Elevated-use stand-off pipes (½ in, NPSM/DN15) M5 mounting hardware and nitrile gasket included 	Die-cast zinc base with black paint	

Foldable Mounting Brackets			
Model	Features	Construction	
SA-FFB12	<ul style="list-style-type: none"> For use with 1/2 inch stand-off pipes Stainless steel hardware 	Black polycarbonate	
SA-FFB12C		Gray polycarbonate	

LMB Sealed Right-Angle Bracket

Model	Description	Construction	
LMB30RA	Direct-Mount Models: Bracket kit with base, 30 mm adapter, set screw, fasteners, O-rings, and gaskets.	Black polycarbonate	
LMB30RAC		Gray polycarbonate	
LMBE12RA	Pipe-Mount Models: Bracket kit with base, 1/2-14 pipe adapter, set screw, fasteners, O-rings, and gaskets. For use with stand-off pipe (listed and sold separately).	Black polycarbonate	
LMBE12RAC		Gray polycarbonate	

Brackets

LMBE12RA35

- Direct mounting of stand-off pipe, with common bracket type
- Zinc-plated steel
- 1/2-14 NPSM nut
- Mounting distance from the wall to the center of the 1/2-14 NPSM nut is 35 mm

Hole center spacing: 20.0

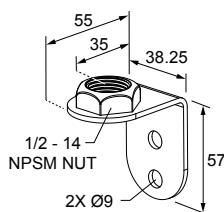

LMBE12RA45

- Direct mounting of stand-off pipe, with common bracket type
- Zinc-plated steel
- 1/2-14 NPSM nut
- Mounting distance from the wall to the center of the 1/2-14 NPSM nut is 45 mm

Hole center spacing: 35.0

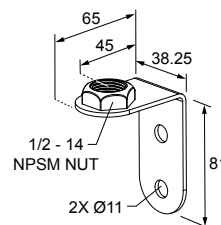

Sun Shield

K90DS

- Use for enhanced visibility in direct sunlight conditions
- Polycarbonate



Banner Engineering Corp. Limited Warranty

Banner Engineering Corp. warrants its products to be free from defects in material and workmanship for one year following the date of shipment. Banner Engineering Corp. will repair or replace, free of charge, any product of its manufacture which, at the time it is returned to the factory, is found to have been defective during the warranty period. This warranty does not cover damage or liability for misuse, abuse, or the improper application or installation of the Banner product.

THIS LIMITED WARRANTY IS EXCLUSIVE AND IN LIEU OF ALL OTHER WARRANTIES WHETHER EXPRESS OR IMPLIED (INCLUDING, WITHOUT LIMITATION, ANY WARRANTY OF MERCHANTABILITY OR FITNESS FOR A PARTICULAR PURPOSE), AND WHETHER ARISING UNDER COURSE OF PERFORMANCE, COURSE OF DEALING OR TRADE USAGE.

This Warranty is exclusive and limited to repair or, at the discretion of Banner Engineering Corp., replacement. **IN NO EVENT SHALL BANNER ENGINEERING CORP. BE LIABLE TO BUYER OR ANY OTHER PERSON OR ENTITY FOR ANY EXTRA COSTS, EXPENSES, LOSSES, LOSS OF PROFITS, OR ANY INCIDENTAL, CONSEQUENTIAL OR SPECIAL DAMAGES RESULTING FROM ANY PRODUCT DEFECT OR FROM THE USE OR INABILITY TO USE THE PRODUCT, WHETHER ARISING IN CONTRACT OR WARRANTY, STATUTE, TORT, STRICT LIABILITY, NEGLIGENCE, OR OTHERWISE.**

Banner Engineering Corp. reserves the right to change, modify or improve the design of the product without assuming any obligations or liabilities relating to any product previously manufactured by Banner Engineering Corp. Any misuse, abuse, or improper application or installation of this product or use of the product for personal protection applications when the product is identified as not intended for such purposes will void the product warranty. Any modifications to this product without prior express approval by Banner Engineering Corp will void the product warranties. All specifications published in this document are subject to change; Banner reserves the right to modify product specifications or update documentation at any time. Specifications and product information in English supersede that which is provided in any other language. For the most recent version of any documentation, refer to: www.bannerengineering.com.

For patent information, see www.bannerengineering.com/patents.