

MICRO SWITCH™ Solenoid Safety Interlock Switches GKL/R Series

004789

Issue 1

Datasheet



DESCRIPTION

MICRO SWITCH™ GKL/R Series switches are a heavy-duty key operated solenoid safety interlock switch incorporating a key trapping mechanism. The trapped key attached to the guard cannot be removed from the switch until the solenoid circuit of the switch has received a remote signal (from a control device) indicating the hazardous process has subsided. This design is for use on machinery where an instant stop is either impossible (due to the momentum of the machine) or impractical due to machine conditions (such as completing a machine cycle or reducing the temperature to a safe level). There are independent contacts inside the key switch which monitor the key position and the solenoid with a range of different contact arrangements to satisfy most application requirements. All normally closed contacts of the switch are positive opening . The key switch also incorporates a manual override feature on the front cover which allows removal of the key for emergency access.

To facilitate installation, the switch is available as a GKL Series (head to the left) or a GKR Series (head to the right). The GKL/R Series switches are designed with dual-entry positions (side or top) for the key.

VALUE TO CUSTOMERS

- Trapped actuator key cannot be removed from the switch until the hazardous condition has subsided
- Trapped key available as a mechanical latch or solenoid latch
- Heavy duty metal housing assembly resists shock, vibration, and oil/coolant sprays
- Side or top entry positions (8 positions) for key
- Multiple positive opening normally closed (NC) contacts and normally open (NO) contacts options
- Lockout device available, key cannot be inserted into switch

FEATURES

- Electrostatic epoxy coated die-cast zinc housing
- Four different rugged stainless steel keys (two rigid and two flexible)
- 1NC/1NO, 2NC, 2NC/1NO, 2NC/2NO, 3NC/1NO, or 4NC contact options each for monitoring the key and the solenoid
- Positive opening normally closed contacts  to EN/IEC 60947-5-1-3 specification
- Mechanical latch (solenoid power to unlock) or solenoid latch (de-energize solenoid to unlock)
- Wide range of supply voltages for solenoid
- Manual unlock feature on front cover
- Two LEDs in housing cover for monitoring the actuator key switch contacts and the solenoid switch contacts
- Different conduit options for global applications
- Operating temp. range: -25 °C to 85 °C [-13 °F to 185 °F]
- Switch body environmentally sealed to IP68 and NEMA 1, 4, 6P, 12, & 13
- CE, CSA, and UL agency certifications
- Designed and agency evaluated for safety functions up to and including a SIL3 level

POTENTIAL APPLICATIONS

- Potential applications include gates, guards, and doors for:
 - Machine tools
 - Metalworking and punch press machinery
 - Plastic molding machines
 - Die cast machinery
 - Robotic cells
 - Special purpose machinery

DIFFERENTIATION

- Up to four electrically independent contacts for each of the key and solenoid for monitoring the respective positions
- Gold contacts available for low energy applications
- Two LED indicators (green and red) to monitor status of key switch and solenoid switch
- Rugged stainless steel rigid and flexible keys
- Designed and evaluated up to and including a safety integrity level (SIL3) per IEC 61508-2:2010

PORTFOLIO

Honeywell safety interlocking switches include the EN50041 metal body [GK Series](#), miniature plastic [GKM Series](#), EN50047 plastic body [GKE Series](#), and plastic body [GKN Series](#). Honeywell also offers non-interlocking safety switches ([GSS Series](#)), non-contact safety switches ([FF Series](#)) and cable/rope-pull safety switches ([1CPS & 2CPS Series](#)).

MICRO SWITCH™ Solenoid Safety Interlock Switches, GKL/R Series

Table 1. Specifications

Characteristic	Parameter
Description	Dual-entry - solenoid safety interlock switch
Certifications	CSA (C22.2 No.14. File57323), UL (UL508, File E37138), CE (IEC 60947-1, IEC 60947-5-1)
Housing material	Epoxy coated die-cast zinc
Key (actuator) material	Stainless steel
Key styles (4)	Straight key, 90° key, flexible key up-down, flexible key side-side
Insertion force (nominal)	35 N [8 lb]
Extraction force (nominal)	28 N [6 lb]
Solenoid locking force	1000 N [224 lb] max.
Solenoid voltages	12 Vdc, 24 Vdc, 48 Vdc, 120 Vac, and 240 Vac
Solenoid power (nominal)	12 W
Conduit/electrical connection	0.5 – 14 NPT, 20 mm, PG13,5 threaded conduit; 10-pin “Mini” style connector
Contact/switch options* for key and solenoid	1NC/1NO, 2 NC, 2NC/2NO, 3NC/1NO, 4NC
Contact design	Double break, electrically separated
Contact material	Silver alloy (standard); gold-plated silver alloy (low energy applications)
Utilization category	AC15, A300; DC13 Q300
Rated operational voltage (Ue)	240 Vac, 250 Vdc
Rated operational current (Ie)	3 A, 0.27 A
Thermal current (Ith)	10 A
Rated insulation voltage (Ui)	600 V
Rated impulse withstand voltage (Uimp)	2500 V
Short circuit protective device (SCPD)	Class J fuse (10 A)
Conditional short-circuit current	1000 A
Pollution degree	3
Environmental sealing	IP68; NEMA 1, 4, 6P, 12, & 13
Operating temperature	-25 °C to 40 °C [-13 °F to 104 °F]
Shock	50 G per IEC 60068-2-27
Vibration	10 G per IEC 60068-2-6
MCTF (Mechanical life)	>2,500,000 cycles with single-sided confidence limit of 95 %
MCTF (Electrical life)	>60,000 cycles
SIL capability	Up to and including SIL3 (HFT1), IEC 61508-2:2010
Proof test interval	1 year
LED pilot lights (2)	One green LED and one red LED to monitor contact positions

*All normally closed (NC) contacts are positive opening .

Table 2. Electrical Rating

ac				dc				gold-plated contacts
A300	AC15	VA Rating		Q300	DC13	VA Rating		1 V 10 µA min. 50 V 100 mA max.
Ue	Ie	Make	Break	Ue	Ie	Make	Break	
Volts	Amps			Volts	Amps			
120	6	7200	720	24	2.8	69	69	
240	3	7200	720	125	0.55	69	69	
				250	0.27	69	69	

MICRO SWITCH™ Solenoid Safety Interlock Switches, GKL/R Series

Figure 1. Product Nomenclature

Switch Type	Body/ Indicator	Conduit	Circuitry	Head	Key*	Type/ Over-ride	Solenoid Voltage	
GK Series Solenoid Safety Interlock Switch	L Head to left with indicators	A 1/2 NPT, Viton seals	2 DPDT 2 snap action	30 4NC, gold 2 slow acting	L Opening to front & top	6 Straight	A Solenoid unlock with screwdriver, slot over-ride	1 12 Vdc
	R Head to right with indicators	B PG 13.5, Viton seals	3 SPDT, BBM 2 slow acting	32 2NC/1NO, BBM gold, 2 slow act.	M Opening to right & top	7 90 degree	B Solenoid unlock without over-ride	2 24 Vdc
	F Head to left without indicators	C 20 mm, Viton seals	6 2NC slow acting	34 2NC/2NO, BBM gold, 2 slow act.	N Opening to back & top	8 Up-down, spring loaded	S Solenoid lock with screwdriver, slot over-ride	3 48 Vdc
	G Head to right without indicators	D PF 1/2, Viton seals	10 4NC slow acting	36 3NC/1NO, BBM gold, 2 slow act.	P Opening to left & top	9 Side-side, spring loaded	T Solenoid lock without over-ride	4 120 Vac
		E 1/2 NPT, Buna-N seals	12 2NC/1NO, BBM slow acting	40 4NC 2 slow acting		X No key		6 240 Vac
		F PG 13.5, Buna-N seals	14 2NC/2NO, BBM slow acting	42 2NC/1NO, BBM 2 slow acting				
		G 20 mm, Buna-N seals	15 2NC/2NO, BBM gold, slow acting	44 2NC/2NO, BBM 2 slow acting				
		H PF 1/2, Buna-N seals	16 3NC/1NO, BBM slow acting	46 3NC/1NO, BBM 2 slow acting				

Keys* Listing	Key style
GKZ56	6 - straight
GKZ57	7 - 90°
GKZ58	8 - up/down
GKZ59	9 - side/side

NOTE: not all combinations of model code are available.
Please contact your Honeywell provider/representative for assistance.

* A key actuator is required for each switch. It can be specified with each switch or ordered separately.

MICRO SWITCH™ Solenoid Safety Interlock Switches, GKL/R Series

Figure 2. Circuit Diagrams for Body/Indicator Codes L or R, A or B Type Over-ride Codes

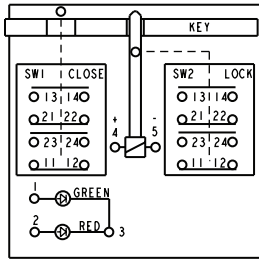

Switch code - 2

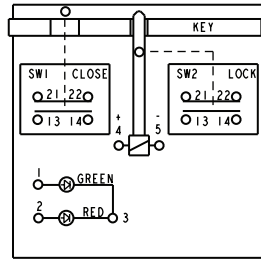

Switch codes - 3 or 4

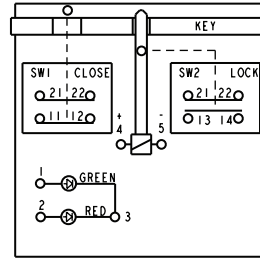

Switch code - 6

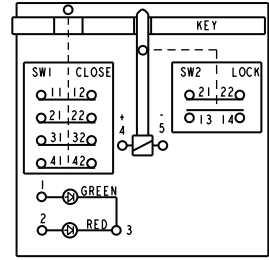

Switch code - 10

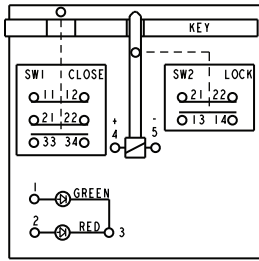

Switch code - 12

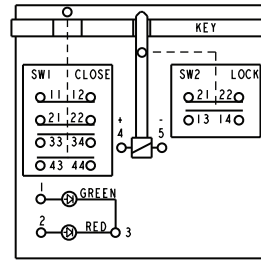

Switch code - 14

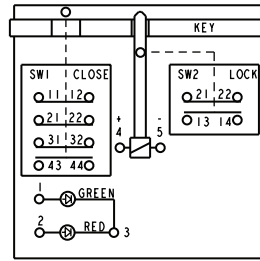

Switch code - 16

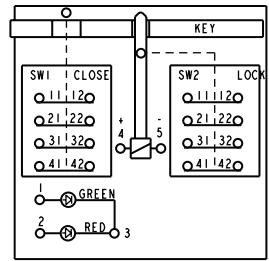

Switch codes - 30 or 40

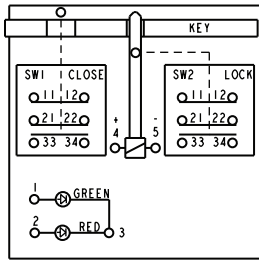

Switch codes - 32 or 42

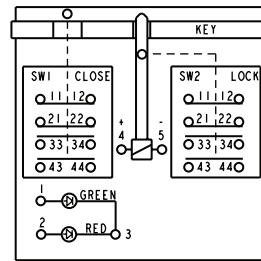

Switch codes - 34 or 44

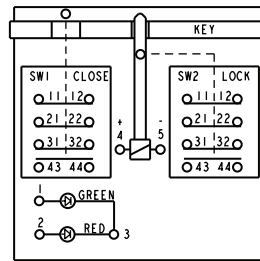

Switch codes - 36 or 46

Body/Indicator Codes - L or R*
Type/Over-ride Codes - A or B*
Diagrams shown with key inserted and locked

NOTE: Integral terminal strip provides wiring points for LEDs and solenoid, as required.

* Reference nomenclature on page 3.

MICRO SWITCH™ Solenoid Safety Interlock Switches, GKL/R Series

Figure 3. Circuit Diagrams for Body/Indicator Codes L or R, S or T Type Over-ride Codes

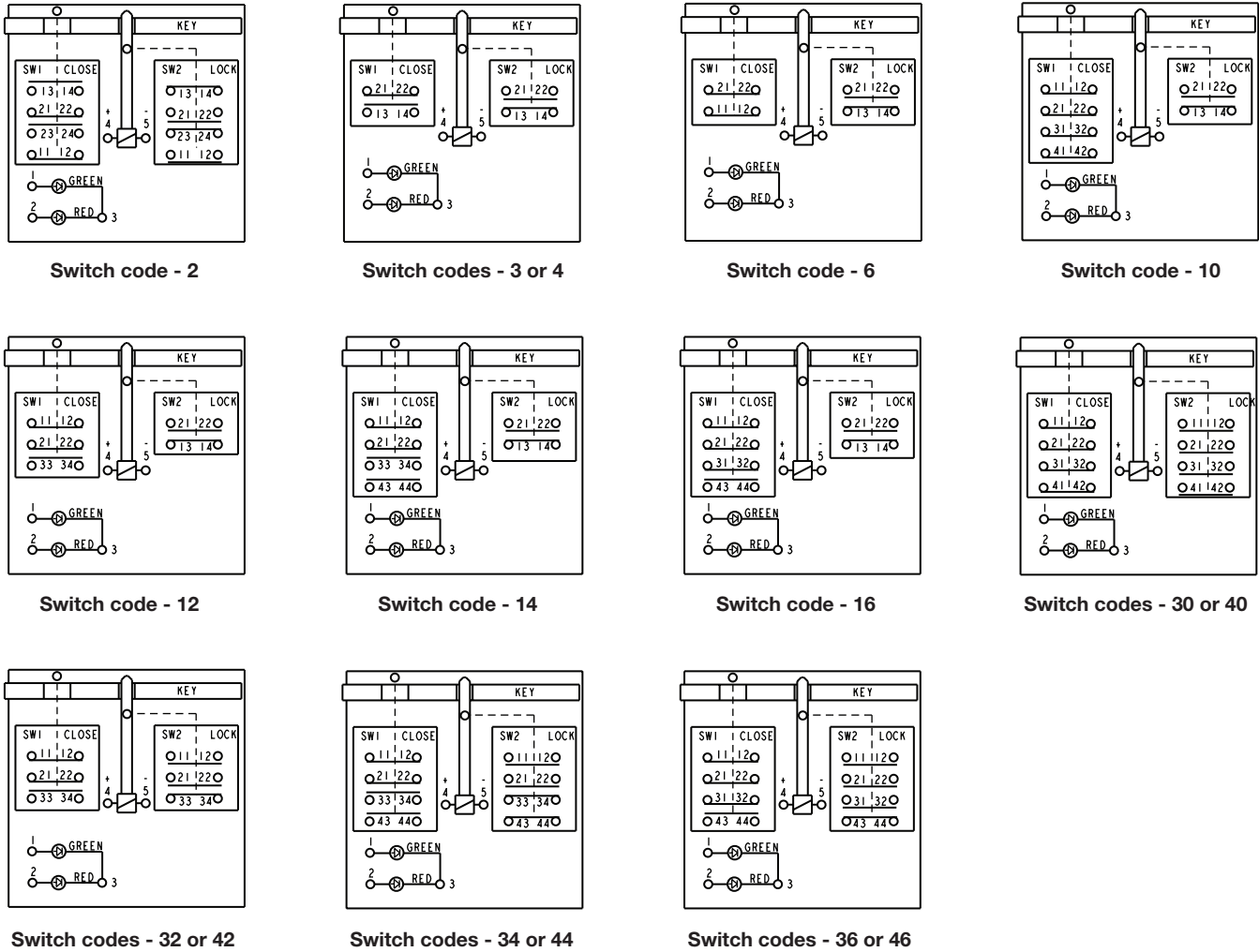

Body/Indicator Codes - L or R*
Type/Over-ride Codes - S or T*
Diagrams shown with key inserted and locked

NOTE: Integral terminal strip provides wiring points for LEDs and solenoid, as required.

* Reference nomenclature on page 3.

MICRO SWITCH™ Solenoid Safety Interlock Switches, GKL/R Series

Figure 4. Circuit Diagrams for Body/Indicator Codes F or G, A or B Type Over-ride Codes

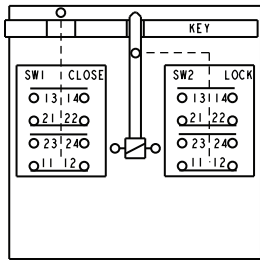

Switch code - 2

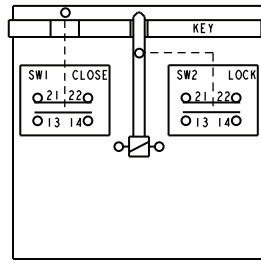

Switch codes - 3 or 4

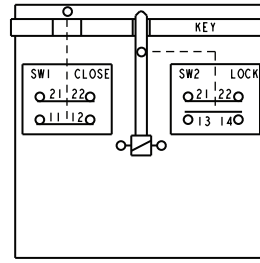

Switch code - 6

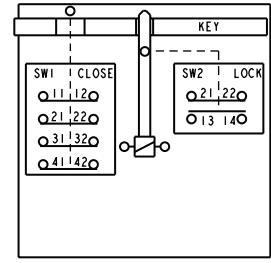

Switch code - 10

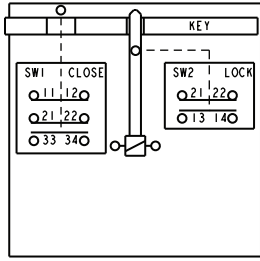

Switch code - 12

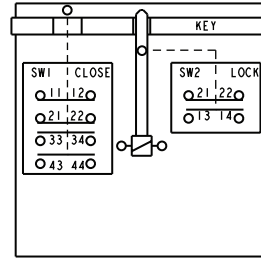

Switch code - 14

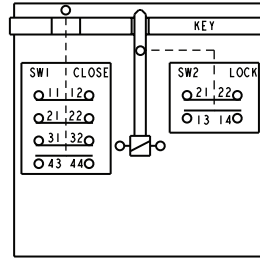

Switch code - 16

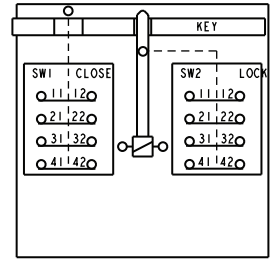

Switch codes - 30 or 40

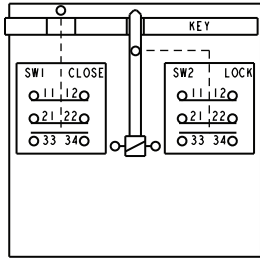

Switch codes - 32 or 42

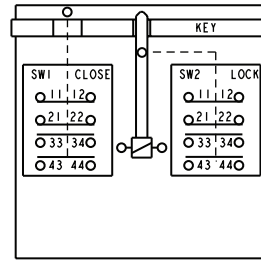

Switch codes - 34 or 44

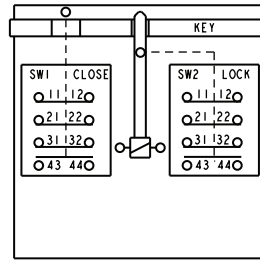

Switch codes - 36 or 46

Body/Indicator Codes - F or G*
Type/Over-ride Codes - A or B*
Diagrams shown with key inserted and locked

NOTE: Integral terminal strip provides wiring points for LEDs and solenoid, as required.

* Reference nomenclature on page 3.

MICRO SWITCH™ Solenoid Safety Interlock Switches, GKL/R Series

Figure 5. Circuit Diagrams for Body/Indicator Codes F or G, S or T Type Over-ride Codes

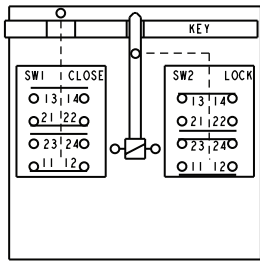

Switch code - 2

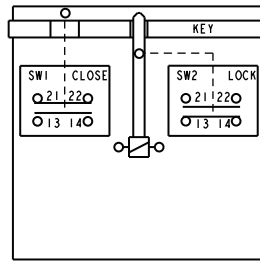

Switch codes - 3 or 4

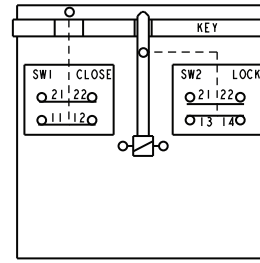

Switch code - 6

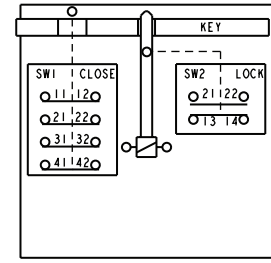

Switch code - 10

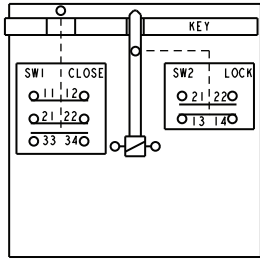

Switch code - 12

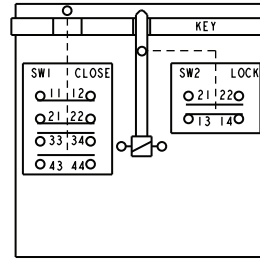

Switch code - 14

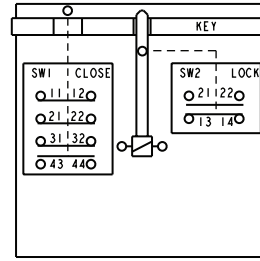

Switch code - 16

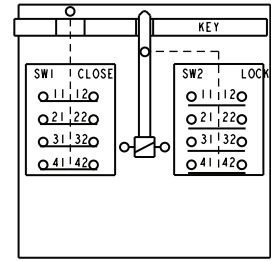

Switch codes - 30 or 40

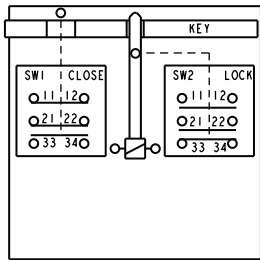

Switch codes - 32 or 42

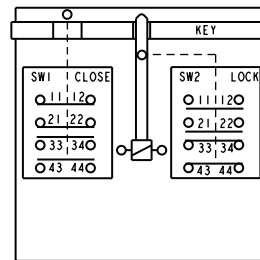

Switch codes - 34 or 44

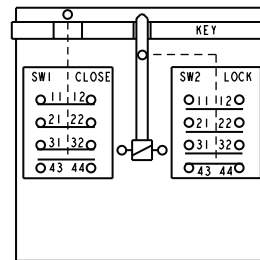

Switch codes - 36 or 46

Body/Indicator Codes - F or G*
Type/Over-ride Codes - S or T*
Diagrams shown with key inserted and locked

NOTE: Integral terminal strip provides wiring points for LEDs and solenoid, as required.

* Reference nomenclature on page 3.

MICRO SWITCH™ Solenoid Safety Interlock Switches, GKL/R Series

Figure 6. 10-Pin Connector Circuit Diagram, Modification Code FW

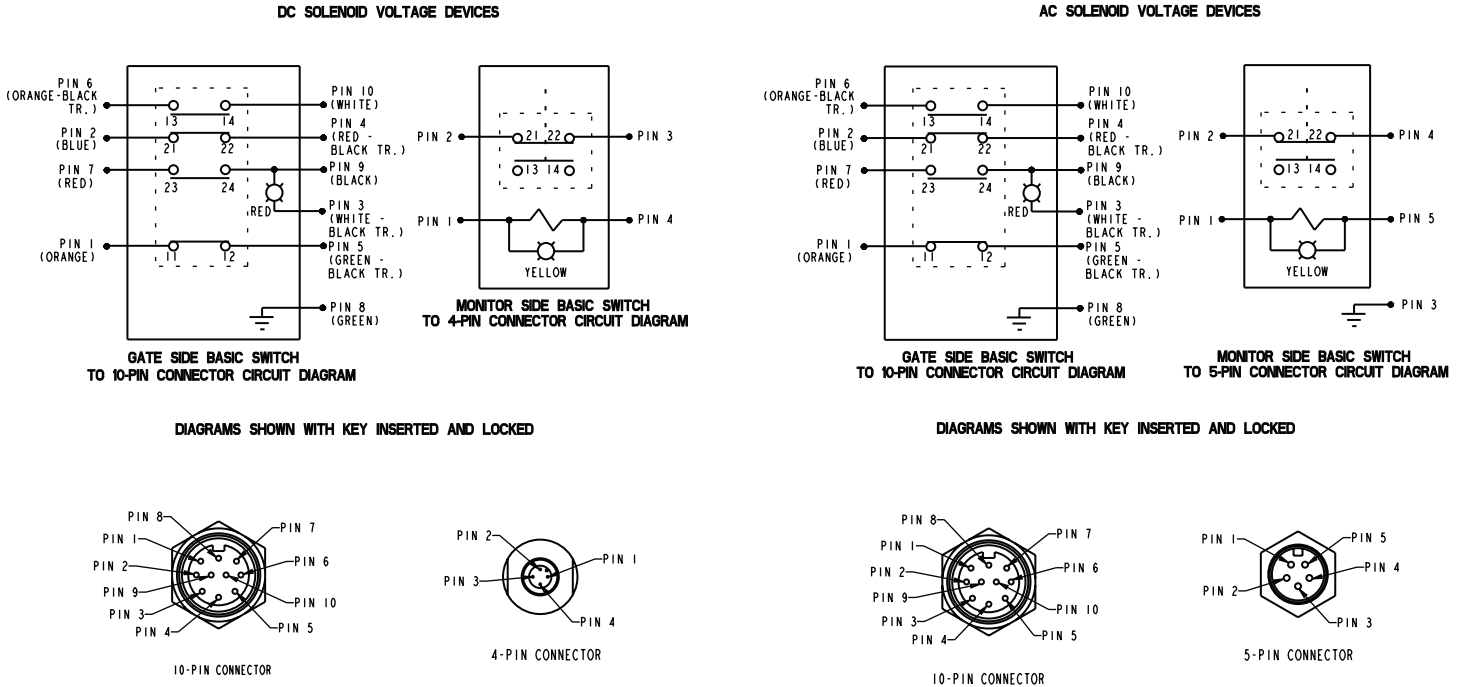

Modification code: -FW

Figure 7. 10-Pin Connector Circuit Diagram, Modification Code F05

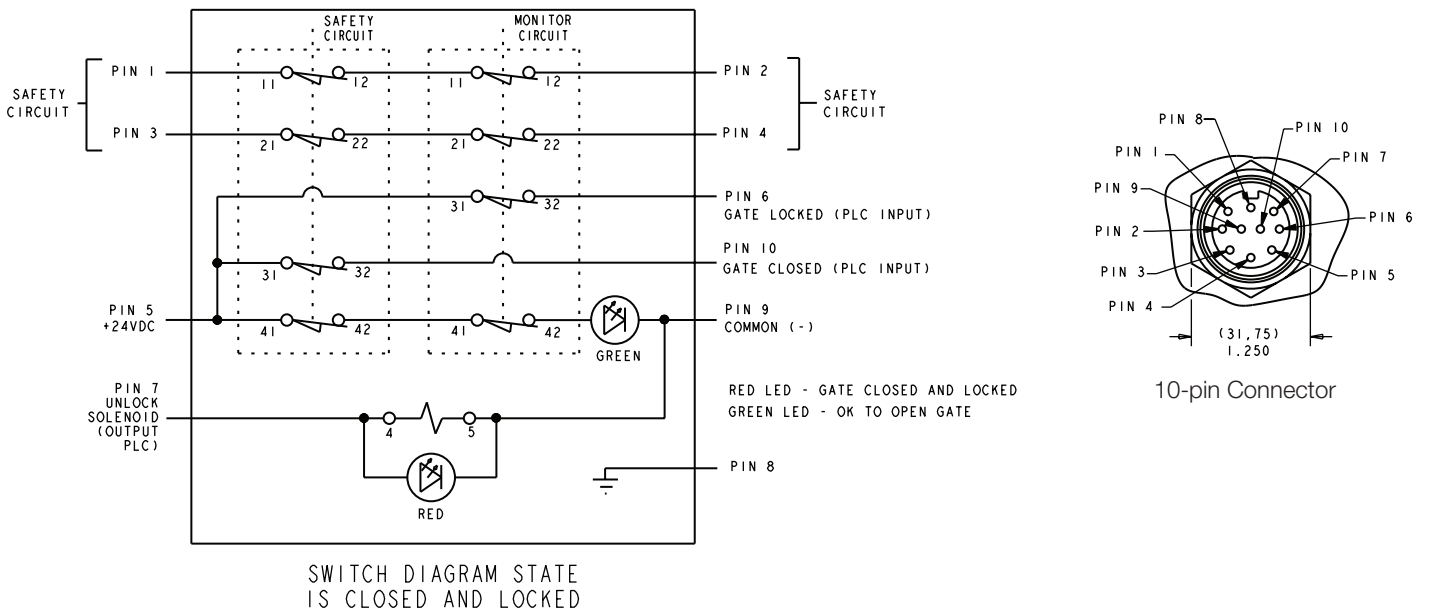

Modification Code: -F05

MICRO SWITCH™ Solenoid Safety Interlock Switches, GKL/R Series

Figure 8. 10-Pin Connector Circuit Diagram, Modification Code F04

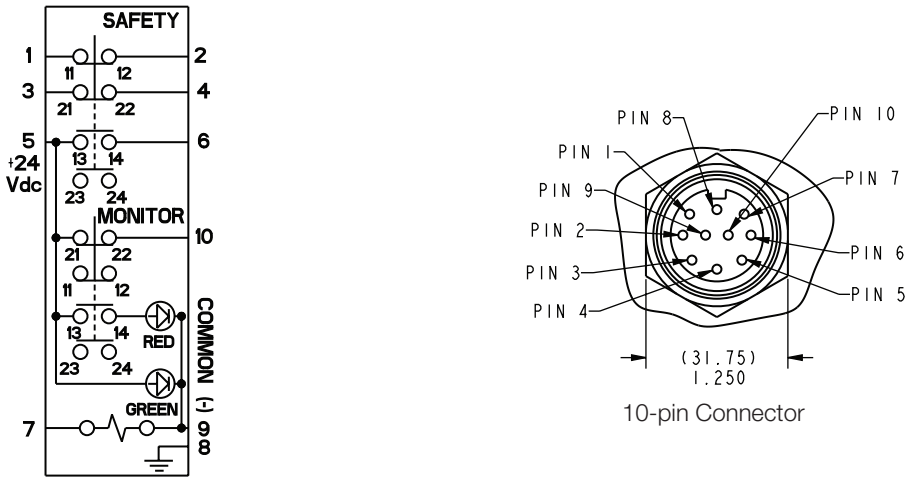

SWITCH DIAGRAM STATE
IS CLOSED AND LOCKED

Modification code: -F04

MICRO SWITCH™ Solenoid Safety Interlock Switches, GKL/R Series

Table 3. GKL Safety Switch Order Guide

Catalog Listing	Body Style (includes 2 LEDs unless noted)	Conduit	Contacts, Switch 1 (key/gate monitor)	Contacts, Switch 2 (solenoid monitor)	Contact Material	Head Position (opening for key)	Key Style	Locking Type/Over-ride	Solenoid Voltage	Enclosure Seal Material
GKLE3LXA2	Head to left	0.5-14 NPT	1NC/1NO slow action, BBM	1NC/1NO slow action, BBM	Silver alloy	Front & Top	–	Mechanical latch with over-ride	24 Vdc	Nitrile seals
GKLE3L6A2	Head to left	0.5-14 NPT	1NC/1NO slow action, BBM	1NC/1NO slow action, BBM	Silver alloy	Front & Top	Straight key	Mechanical latch with over-ride	24 Vdc	Nitrile seals
GKLE3L6A4	Head to left	0.5-14 NPT	1NC/1NO slow action, BBM	1NC/1NO slow action, BBM	Silver alloy	Front & Top	Straight key	Mechanical latch with over-ride	120 Vac	Nitrile seals
GKLE3L6S4	Head to left	0.5-14 NPT	1NC/1NO slow action, BBM	1NC/1NO slow action, BBM	Silver alloy	Front & Top	Straight key	Solenoid latch with over-ride	120 Vac	Nitrile seals
GKLE3L7A2	Head to left	0.5-14 NPT	1NC/1NO slow action, BBM	1NC/1NO slow action, BBM	Silver alloy	Front & Top	90° key	Mechanical latch with over-ride	24 Vdc	Nitrile seals
GKLE3L7A4	Head to left	0.5-14 NPT	1NC/1NO slow action, BBM	1NC/1NO slow action, BBM	Silver alloy	Front & Top	90° key	Mechanical latch with over-ride	120 Vac	Nitrile seals
GKLE3L7S2	Head to left	0.5-14 NPT	1NC/1NO slow action, BBM	1NC/1NO slow action, BBM	Silver alloy	Front & Top	90° key	Solenoid latch with over-ride	24 Vdc	Nitrile seals
GKLE3L9A4	Head to left	0.5-14 NPT	1NC/1NO slow action, BBM	1NC/1NO slow action, BBM	Silver alloy	Front & Top	Spring-loaded, side-side	Mechanical latch with over-ride	120 Vac	Nitrile seals
GKLE3L9S4	Head to left	0.5-14 NPT	1NC/1NO slow action, BBM	1NC/1NO slow action, BBM	Silver alloy	Front & Top	Spring-loaded, side-side	Solenoid latch with over-ride	120 Vac	Nitrile seals
GKLF3L7S6	Head to left	PG 13,5	1NC/1NO slow action, BBM	1NC/1NO slow action, BBM	Silver alloy	Front & Top	90° key	Solenoid latch with over-ride	240 Vac	Nitrile seals
GKLG3L6A2	Head to left	20 mm	1NC/1NO slow action, BBM	1NC/1NO slow action, BBM	Silver alloy	Front & Top	Straight key	Mechanical latch with over-ride	24 Vdc	Nitrile seals
GKLE3PXA4	Head to left	0.5-14 NPT	1NC/1NO slow action, BBM	1NC/1NO slow action, BBM	Silver alloy	Left & Top	–	Mechanical latch with over-ride	120 Vac	Nitrile seals
GKLE3PXS2	Head to left	0.5-14 NPT	1NC/1NO slow action, BBM	1NC/1NO slow action, BBM	Silver alloy	Left & Top	–	Solenoid latch with over-ride	24 Vdc	Nitrile seals
GKLG3PXS2	Head to left	20 mm	1NC/1NO slow action, BBM	1NC/1NO slow action, BBM	Silver alloy	Left & Top	–	Solenoid latch with over-ride	24 Vdc	Nitrile seals
GKFE3P7T4	Head to left (no LED indicators)	0.5-14 NPT	1NC/1NO slow action, BBM	1NC/1NO slow action, BBM	Silver alloy	Left & Top	90° key	Solenoid latch without over-ride	120 Vac	Nitrile seals
GKLA3P7S4	Head to left	0.5-14 NPT	1NC/1NO slow action, BBM	1NC/1NO slow action, BBM	Silver alloy	Left & Top	90° key	Solenoid latch with over-ride	120 Vac	Fluorocarbon seals
GKLE6L7S2	Head to left	0.5-14 NPT	2NC slow action	1NC/1NO slow action, BBM	Silver alloy	Front & Top	90° key	Solenoid latch with over-ride	24 Vdc	Nitrile seals
GKLF6L7A2	Head to left	PG 13,5	2NC slow action	1NC/1NO slow action, BBM	Silver alloy	Front & Top	90° key	Mechanical latch with over-ride	24 Vdc	Nitrile seals
GKLG6L6A2	Head to left	20 mm	2NC slow action	1NC/1NO slow action, BBM	Silver alloy	Front & Top	Straight key	Mechanical latch with over-ride	24 Vdc	Nitrile seals
GKFE12L7B2	Head to left (no LED indicators)	0.5-14 NPT	2NC/1NO slow action, BBM	1NC/1NO slow action, BBM	Silver alloy	Front & Top	90° key	Mechanical latch without over-ride	24 Vdc	Nitrile seals
GKFE12L7T2	Head to left (no LED indicators)	0.5-14 NPT	2NC/1NO slow action, BBM	1NC/1NO slow action, BBM	Silver alloy	Front & Top	90° key	Solenoid latch without over-ride	24 Vdc	Nitrile seals
GKFG14LXA2	Head to left (no LED indicators)	20 mm	2NC/2NO slow action, BBM	1NC/1NO slow action, BBM	Silver alloy	Front & Top	–	Mechanical latch with over-ride	24 Vdc	Nitrile seals
GKLC14L6A2	Head to left	20 mm	2NC/2NO slow action, BBM	1NC/1NO slow action, BBM	Silver alloy	Front & Top	Straight key	Mechanical latch with over-ride	24 Vdc	Fluorocarbon seals
GKLA2P9S2	Head to left	0.5-14 NPT	2NC/2NO snap action	2NC/2NO snap action	Silver alloy	Left & Top	Spring-loaded, side-side	Solenoid latch with over-ride	24 Vdc	Fluorocarbon seals
GKLE44L6S4	Head to left	0.5-14 NPT	2NC/2NO slow action, BBM	2NC/2NO slow action, BBM	Silver alloy	Front & Top	Straight key	Solenoid latch with over-ride	120 Vac	Nitrile seals

MICRO SWITCH™ Solenoid Safety Interlock Switches, GKL/R Series

Table 3. GKL Safety Switch Order Guide (continued)

Catalog Listing	Body Style (includes 2 LEDs unless noted)	Conduit	Contacts, Switch 1 (key/gate monitor)	Contacts, Switch 2 (solenoid monitor)	Contact Material	Head Position (opening for key)	Key Style	Locking Type/Over-ride	Solenoid Voltage	Enclosure Seal Material
GKLE44L7A2	Head to left	0.5-14 NPT	2NC/2NO slow action, BBM	2NC/2NO slow action, BBM	Silver alloy	Front & Top	90° key	Mechanical latch with over-ride	24 Vdc	Nitrile seals
GKLE44L7A4	Head to left	0.5-14 NPT	2NC/2NO slow action, BBM	2NC/2NO slow action, BBM	Silver alloy	Front & Top	90° key	Mechanical latch with over-ride	120 Vac	Nitrile seals
GKLE44L7T4	Head to left	0.5-14 NPT	2NC/2NO slow action, BBM	2NC/2NO slow action, BBM	Silver alloy	Front & Top	90° key	Solenoid latch without over-ride	120 Vac	Nitrile seals
GKLE44L8A2	Head to left	0.5-14 NPT	2NC/2NO slow action, BBM	2NC/2NO slow action, BBM	Silver alloy	Front & Top	Spring-loaded, up-down	Mechanical latch with over-ride	24 Vdc	Nitrile seals
GKLE44L8A4	Head to left	0.5-14 NPT	2NC/2NO slow action, BBM	2NC/2NO slow action, BBM	Silver alloy	Front & Top	Spring-loaded, up-down	Mechanical latch with over-ride	120 Vac	Nitrile seals
GKLE44L9A2	Head to left	0.5-14 NPT	2NC/2NO slow action, BBM	2NC/2NO slow action, BBM	Silver alloy	Front & Top	Spring-loaded, side-side	Mechanical latch with over-ride	24 Vdc	Nitrile seals
GKLE44L9A4	Head to left	0.5-14 NPT	2NC/2NO slow action, BBM	2NC/2NO slow action, BBM	Silver alloy	Front & Top	Spring-loaded, side-side	Mechanical latch with over-ride	120 Vac	Nitrile seals
GKLF44LXS2	Head to left	PG 13,5	2NC/2NO slow action, BBM	2NC/2NO slow action, BBM	Silver alloy	Front & Top	–	Solenoid latch with over-ride	24 Vdc	Nitrile seals
GKLF44L6A2	Head to left	PG 13,5	2NC/2NO slow action, BBM	2NC/2NO slow action, BBM	Silver alloy	Front & Top	Straight key	Mechanical latch with over-ride	24 Vdc	Nitrile seals
GKLF44L7A2	Head to left	PG 13,5	2NC/2NO slow action, BBM	2NC/2NO slow action, BBM	Silver alloy	Front & Top	90° key	Mechanical latch with over-ride	24 Vdc	Nitrile seals
GKLF44L8A2	Head to left	PG 13,5	2NC/2NO slow action, BBM	2NC/2NO slow action, BBM	Silver alloy	Front & Top	Spring-loaded, up-down	Mechanical latch with over-ride	24 Vdc	Nitrile seals
GKLF44L9A2	Head to left	PG 13,5	2NC/2NO slow action, BBM	2NC/2NO slow action, BBM	Silver alloy	Front & Top	Spring-loaded, side-side	Mechanical latch with over-ride	24 Vdc	Nitrile seals
GKLG44LXS2	Head to left	20 mm	2NC/2NO slow action, BBM	2NC/2NO slow action, BBM	Silver alloy	Front & Top	–	Solenoid latch with over-ride	24 Vdc	Nitrile seals
GKLG44L6A2	Head to left	20 mm	2NC/2NO slow action, BBM	2NC/2NO slow action, BBM	Silver alloy	Front & Top	Straight key	Mechanical latch with over-ride	24 Vdc	Nitrile seals
GKLG44L7A2	Head to left	20 mm	2NC/2NO slow action, BBM	2NC/2NO slow action, BBM	Silver alloy	Front & Top	90° key	Mechanical latch with over-ride	24 Vdc	Nitrile seals
GKLG44L8A2	Head to left	20 mm	2NC/2NO slow action, BBM	2NC/2NO slow action, BBM	Silver alloy	Front & Top	Spring-loaded, up-down	Mechanical latch with over-ride	24 Vdc	Nitrile seals
GKLG44L9A2	Head to left	20 mm	2NC/2NO slow action, BBM	2NC/2NO slow action, BBM	Silver alloy	Front & Top	Spring-loaded, side-side	Mechanical latch with over-ride	24 Vdc	Nitrile seals
GKLE44PXT2	Head to left	0.5-14 NPT	2NC/2NO slow action, BBM	2NC/2NO slow action, BBM	Silver alloy	Left & Top	–	Solenoid latch without over-ride	24 Vdc	Nitrile seals
GKLE44P6A4	Head to left	0.5-14 NPT	2NC/2NO slow action, BBM	2NC/2NO slow action, BBM	Silver alloy	Left & Top	Straight key	Mechanical latch with over-ride	120 Vac	Nitrile seals
GKLE44P7S4	Head to left	0.5-14 NPT	2NC/2NO slow action, BBM	2NC/2NO slow action, BBM	Silver alloy	Left & Top	90° key	Solenoid latch with over-ride	120 Vac	Nitrile seals
GKLE44P7T4	Head to left	0.5-14 NPT	2NC/2NO slow action, BBM	2NC/2NO slow action, BBM	Silver alloy	Left & Top	90° key	Solenoid latch without over-ride	120 Vac	Nitrile seals
GKLG44PXA2	Head to left	20 mm	2NC/2NO slow action, BBM	2NC/2NO slow action, BBM	Silver alloy	Left & Top	–	Mechanical latch with over-ride	24 Vdc	Nitrile seals
GKLG44PXB2	Head to left	20 mm	2NC/2NO slow action, BBM	2NC/2NO slow action, BBM	Silver alloy	Left & Top	–	Mechanical latch without over-ride	24 Vdc	Nitrile seals
GKLG44P6S4	Head to left	20 mm	2NC/2NO slow action, BBM	2NC/2NO slow action, BBM	Silver alloy	Left & Top	Straight key	Solenoid latch with over-ride	120 Vac	Nitrile seals

MICRO SWITCH™ Solenoid Safety Interlock Switches, GKL/R Series

Table 3. GKL Safety Switch Order Guide (continued)

Catalog Listing	Body Style (includes 2 LEDs unless noted)	Conduit	Contacts, Switch 1 (key/gate monitor)	Contacts, Switch 2 (solenoid monitor)	Contact Material	Head Position (opening for key)	Key Style	Locking Type/Over-ride	Solenoid Voltage	Enclosure Seal Material
GKFE16LXA2	Head to left (no LED indicators)	0.5-14 NPT	3NC/1NO slow action, BBM	1NC/1NO slow action, BBM	Silver alloy	Front & Top	–	Mechanical latch with over-ride	24 Vdc	Nitrile seals
GKFE16LXA4	Head to left (no LED indicators)	0.5-14 NPT	3NC/1NO slow action, BBM	1NC/1NO slow action, BBM	Silver alloy	Front & Top	–	Mechanical latch with over-ride	120 Vac	Nitrile seals
GKFE16LXA6	Head to left (no LED indicators)	0.5-14 NPT	3NC/1NO slow action, BBM	1NC/1NO slow action, BBM	Silver alloy	Front & Top	–	Mechanical latch with over-ride	240 Vac	Nitrile seals
GKLG16L6A2	Head to left	20 mm	3NC/1NO slow action, BBM	1NC/1NO slow action, BBM	Silver alloy	Front & Top	Straight key	Mechanical latch with over-ride	24 Vdc	Nitrile seals
GKLG16L6S2	Head to left	20 mm	3NC/1NO slow action, BBM	1NC/1NO slow action, BBM	Silver alloy	Front & Top	Straight key	Solenoid latch with over-ride	24 Vdc	Nitrile seals
GKLG16L7A2	Head to left	20 mm	3NC/1NO slow action, BBM	1NC/1NO slow action, BBM	Silver alloy	Front & Top	90° key	Mechanical latch with over-ride	24 Vdc	Nitrile seals
GKLG16L7S2	Head to left	20 mm	3NC/1NO slow action, BBM	1NC/1NO slow action, BBM	Silver alloy	Front & Top	90° key	Solenoid latch with over-ride	24 Vdc	Nitrile seals
GKLE46LXA2	Head to left	0.5-14 NPT	3NC/1NO slow action, BBM	3NC/1NO slow action BBM	Silver alloy	Front & Top	–	Mechanical latch with over-ride	24 Vdc	Nitrile seals
GKLA46L6A4	Head to left	0.5-14 NPT	3NC/1NO slow action, BBM	3NC/1NO slow action BBM	Silver alloy	Front & Top	Straight key	Mechanical latch with over-ride	120 Vac	Fluorocarbon seals
GKLG46L6A2	Head to left	20 mm	3NC/1NO slow action, BBM	3NC/1NO slow action BBM	Silver alloy	Front & Top	Straight key	Mechanical latch with over-ride	24 Vdc	Nitrile seals
GKLE46L7A2	Head to left	0.5-14 NPT	3NC/1NO slow action, BBM	3NC/1NO slow action BBM	Silver alloy	Front & Top	90° key	Mechanical latch with over-ride	24 Vdc	Nitrile seals
GKLE46L7S4	Head to left	0.5-14 NPT	3NC/1NO slow action, BBM	3NC/1NO slow action BBM	Silver alloy	Front & Top	90° key	Solenoid latch with over-ride	120 Vac	Nitrile seals
GKLG46L7A2	Head to left	20 mm	3NC/1NO slow action, BBM	3NC/1NO slow action BBM	Silver alloy	Front & Top	90° key	Mechanical latch with over-ride	24 Vdc	Nitrile seals
GKLG46L7A6	Head to left	20 mm	3NC/1NO slow action, BBM	3NC/1NO slow action BBM	Silver alloy	Front & Top	90° key	Mechanical latch with over-ride	240 Vac	Nitrile seals
GKLG46L7S2	Head to left	20 mm	3NC/1NO slow action, BBM	3NC/1NO slow action BBM	Silver alloy	Front & Top	90° key	Solenoid latch with over-ride	24 Vdc	Nitrile seals
GKLE46L9A2	Head to left	0.5-14 NPT	3NC/1NO slow action, BBM	3NC/1NO slow action BBM	Silver alloy	Front & Top	Spring-loaded, side-side	Mechanical latch with over-ride	24 Vdc	Nitrile seals
GKLE46L9A4	Head to left	0.5-14 NPT	3NC/1NO slow action, BBM	3NC/1NO slow action BBM	Silver alloy	Front & Top	Spring-loaded, side-side	Mechanical latch with over-ride	120 Vac	Nitrile seals
GKLE46P7A4	Head to left	0.5-14 NPT	3NC/1NO slow action, BBM	3NC/1NO slow action BBM	Silver alloy	Left & Top	90° key	Mechanical latch with over-ride	120 Vac	Nitrile seals
GKLF46PXB2	Head to left	PG 13,5	3NC/1NO slow action, BBM	3NC/1NO slow action BBM	Silver alloy	Left & Top	–	Mechanical latch without over-ride	24 Vdc	Nitrile seals
GKLG46P6A2	Head to left	20 mm	3NC/1NO slow action, BBM	3NC/1NO slow action BBM	Silver alloy	Left & Top	Straight key	Mechanical latch with over-ride	24 Vdc	Nitrile seals
GKLA36LXA2	Head to left	0.5-14 NPT	3NC/1NO slow action, BBM	3NC/1NO slow action BBM	Gold-plated	Front & Top	–	Mechanical latch with over-ride	24 Vdc	Fluorocarbon seals
GKLE36MXS4	Head to left	0.5-14 NPT	3NC/1NO slow action, BBM	3NC/1NO slow action BBM	Gold-plated	Right & Top	–	Solenoid latch with over-ride	120 Vac	Nitrile seals
GKLE36PXA2	Head to left	0.5-14 NPT	3NC/1NO slow action, BBM	3NC/1NO slow action BBM	Gold-plated	Left & Top	–	Mechanical latch with over-ride	24 Vdc	Nitrile seals
GKLE36PXA2-F22	Head to left, LEDs are not polarity sensitive	0.5-14 NPT	3NC/1NO slow action, BBM	3NC/1NO slow action BBM	Gold-plated	Left & Top	–	Mechanical latch with over-ride	24 Vdc	Nitrile seals
GKLE36PXS2	Head to left	0.5-14 NPT	3NC/1NO slow action, BBM	3NC/1NO slow action BBM	Gold-plated	Left & Top	–	Solenoid latch with over-ride	24 Vdc	Nitrile seals

MICRO SWITCH™ Solenoid Safety Interlock Switches, GKL/R Series

Table 3. GKL Safety Switch Order Guide (continued)

Catalog Listing	Body Style (includes 2 LEDs unless noted)	Conduit	Contacts, Switch 1 (key/gate monitor)	Contacts, Switch 2 (solenoid monitor)	Contact Material	Head Position (opening for key)	Key Style	Locking Type/Over-ride	Solenoid Voltage	Enclosure Seal Material
GKLG36PXA2	Head to left	20 mm	3NC/1NO slow action, BBM	3NC/1NO slow action BBM	Gold-plated	Left & Top	–	Mechanical latch with over-ride	24 Vdc	Nitrile seals
GKLG36PXS2	Head to left	20 mm	3NC/1NO slow action, BBM	3NC/1NO slow action BBM	Gold-plated	Left & Top	–	Solenoid latch with over-ride	24 Vdc	Nitrile seals
GKLE40LXA2	Head to left	0.5-14 NPT	4NC slow action	4NC slow action	Silver alloy	Front & Top	–	Mechanical latch with over-ride	24 Vdc	Nitrile seals
GKLE40LXA4	Head to left	0.5-14 NPT	4NC slow action	4NC slow action	Silver alloy	Front & Top	–	Mechanical latch with over-ride	120 Vac	Nitrile seals
GKLA40L6A2	Head to left	0.5-14 NPT	4NC slow action	4NC slow action	Silver alloy	Front & Top	Straight key	Mechanical latch with over-ride	24 Vdc	Fluorocarbon seals

MICRO SWITCH™ Solenoid Safety Interlock Switches, GKL/R Series

Table 4. GKR Safety Switch Order Guide

Catalog Listing	Body Style (includes 2 LEDs unless noted)	Conduit	Contacts, Switch 1 (key/gate monitor)	Contacts, Switch 2 (solenoid monitor)	Contact Material	Head Position (opening for key)	Key Style	Locking Type/Over-ride	Solenoid Voltage	Enclosure Seal Material
GKRE3LXA2	Head to right	0.5-14 NPT	1NC/1NO slow action, BBM	1NC/1NO slow action, BBM	Silver alloy	Front & Top	–	Mechanical latch with over-ride	24 Vdc	Nitrile seals
GKRA3LXA2	Head to right	0.5-14 NPT	1NC/1NO slow action, BBM	1NC/1NO slow action, BBM	Silver alloy	Front & Top	–	Mechanical latch with over-ride	24 Vdc	Fluorocarbon seals
GKRE3LXA4	Head to right	0.5-14 NPT	1NC/1NO slow action, BBM	1NC/1NO slow action, BBM	Silver alloy	Front & Top	–	Mechanical latch with over-ride	120 Vac	Nitrile seals
GKRE3LXS4	Head to right	0.5-14 NPT	1NC/1NO slow action, BBM	1NC/1NO slow action, BBM	Silver alloy	Front & Top	–	Solenoid latch with over-ride	120 Vac	Nitrile seals
GKRE3L6A2	Head to right	0.5-14 NPT	1NC/1NO slow action, BBM	1NC/1NO slow action, BBM	Silver alloy	Front & Top	Straight key	Mechanical latch with over-ride	24 Vdc	Nitrile seals
GKRE3L6A4	Head to right	0.5-14 NPT	1NC/1NO slow action, BBM	1NC/1NO slow action, BBM	Silver alloy	Front & Top	Straight key	Mechanical latch with over-ride	120 Vac	Nitrile seals
GKRE3L6S4	Head to right	0.5-14 NPT	1NC/1NO slow action, BBM	1NC/1NO slow action, BBM	Silver alloy	Front & Top	Straight key	Solenoid latch with over-ride	120 Vac	Nitrile seals
GKRE3L7A2	Head to right	0.5-14 NPT	1NC/1NO slow action, BBM	1NC/1NO slow action, BBM	Silver alloy	Front & Top	90° key	Mechanical latch with over-ride	24 Vdc	Nitrile seals
GKRE3L7S2	Head to right	0.5-14 NPT	1NC/1NO slow action, BBM	1NC/1NO slow action, BBM	Silver alloy	Front & Top	90° key	Solenoid latch with over-ride	24 Vdc	Nitrile seals
GKRE3MXS2	Head to right	0.5-14 NPT	1NC/1NO slow action, BBM	1NC/1NO slow action, BBM	Silver alloy	Right & Top	–	Solenoid latch with over-ride	24 Vdc	Nitrile seals
GKRG3MXA2	Head to right	20 mm	1NC/1NO slow action, BBM	1NC/1NO slow action, BBM	Silver alloy	Right & Top	–	Mechanical latch with over-ride	24 Vdc	Nitrile seals
GKRG3MXS2	Head to right	20 mm	1NC/1NO slow action, BBM	1NC/1NO slow action, BBM	Silver alloy	Right & Top	–	Solenoid latch with over-ride	24 Vdc	Nitrile seals
GKRE3M6S4	Head to right	0.5-14 NPT	1NC/1NO slow action, BBM	1NC/1NO slow action, BBM	Silver alloy	Right & Top	Straight key	Solenoid latch with over-ride	120 Vac	Nitrile seals
GKRE3M7A2	Head to right	0.5-14 NPT	1NC/1NO slow action, BBM	1NC/1NO slow action, BBM	Silver alloy	Right & Top	90° key	Mechanical latch with over-ride	24 Vdc	Nitrile seals
GKRE3M9A2	Head to right	0.5-14 NPT	1NC/1NO slow action, BBM	1NC/1NO slow action, BBM	Silver alloy	Right & Top	Spring-loaded, side-side	Mechanical latch with over-ride	24 Vdc	Nitrile seals
GKRE6LXA4	Head to right	0.5-14 NPT	2NC slow action	1NC/1NO slow action, BBM	Silver alloy	Front & Top	–	Mechanical latch with over-ride	120 Vac	Nitrile seals
GKRE6L7A4	Head to right	0.5-14 NPT	2NC slow action	1NC/1NO slow action, BBM	Silver alloy	Front & Top	90° key	Mechanical latch with over-ride	120 Vac	Nitrile seals
GKRE6L7S2	Head to right	0.5-14 NPT	2NC slow action	1NC/1NO slow action, BBM	Silver alloy	Front & Top	90° key	Solenoid latch with over-ride	24 Vdc	Nitrile seals
GKRE6L7S4	Head to right	0.5-14 NPT	2NC slow action	1NC/1NO slow action, BBM	Silver alloy	Front & Top	90° key	Solenoid latch with over-ride	120 Vac	Nitrile seals
GKRB6M7S6	Head to right	PG 13,5	2NC slow action	1NC/1NO slow action, BBM	Silver alloy	Right & Top	90° key	Solenoid latch with over-ride	240 Vac	Fluorocarbon seals
GKRA2LXA4	Head to right	0.5-14 NPT	2NC/2NO snap action	2NC/2NO snap action	Silver alloy	Front & Top	–	Mechanical latch with over-ride	120 Vac	Fluorocarbon seals
GKRE44LXA2	Head to right	0.5-14 NPT	2NC/2NO slow action, BBM	2NC/2NO slow action, BBM	Silver alloy	Front & Top	–	Mechanical latch with over-ride	24 Vdc	Nitrile seals
GKRE44LXA4	Head to right	0.5-14 NPT	2NC/2NO slow action, BBM	2NC/2NO slow action, BBM	Silver alloy	Front & Top	–	Mechanical latch with over-ride	120 Vac	Nitrile seals
GKRE44L6A2	Head to right	0.5-14 NPT	2NC/2NO slow action, BBM	2NC/2NO slow action, BBM	Silver alloy	Front & Top	Straight key	Mechanical latch with over-ride	24 Vdc	Nitrile seals
GKRA44L6A2	Head to right	0.5-14 NPT	2NC/2NO slow action, BBM	2NC/2NO slow action, BBM	Silver alloy	Front & Top	Straight key	Mechanical latch with over-ride	24 Vdc	Fluorocarbon seals

MICRO SWITCH™ Solenoid Safety Interlock Switches, GKL/R Series

Table 4. GKR Safety Switch Order Guide (continued)

Catalog Listing	Body Style (includes 2 LEDs unless noted)	Conduit	Contacts, Switch 1 (key/gate monitor)	Contacts, Switch 2 (solenoid monitor)	Contact Material	Head Position (opening for key)	Key Style	Locking Type/Over-ride	Solenoid Voltage	Enclosure Seal Material
GKRF44L6A2	Head to right	PG 13,5	2NC/2NO slow action, BBM	2NC/2NO slow action, BBM	Silver alloy	Front & Top	Straight key	Mechanical latch with over-ride	24 Vdc	Nitrile seals
GKRG44L6A2	Head to right	20 mm	2NC/2NO slow action, BBM	2NC/2NO slow action, BBM	Silver alloy	Front & Top	Straight key	Mechanical latch with over-ride	24 Vdc	Nitrile seals
GKRE44L6A4	Head to right	0.5-14 NPT	2NC/2NO slow action, BBM	2NC/2NO slow action, BBM	Silver alloy	Front & Top	Straight key	Mechanical latch with over-ride	120 Vac	Nitrile seals
GKRE44L6S4	Head to right	0.5-14 NPT	2NC/2NO slow action, BBM	2NC/2NO slow action, BBM	Silver alloy	Front & Top	Straight key	Solenoid latch with over-ride	120 Vac	Nitrile seals
GKRE44L7A2	Head to right	0.5-14 NPT	2NC/2NO slow action, BBM	2NC/2NO slow action, BBM	Silver alloy	Front & Top	90° key	Mechanical latch with over-ride	24 Vdc	Nitrile seals
GKRA44L7A2	Head to right	0.5-14 NPT	2NC/2NO slow action, BBM	2NC/2NO slow action, BBM	Silver alloy	Front & Top	90° key	Mechanical latch with over-ride	24 Vdc	Fluorocarbon seals
GKRF44L7A2	Head to right	PG 13,5	2NC/2NO slow action, BBM	2NC/2NO slow action, BBM	Silver alloy	Front & Top	90° key	Mechanical latch with over-ride	24 Vdc	Nitrile seals
GKRG44L7A2	Head to right	20 mm	2NC/2NO slow action, BBM	2NC/2NO slow action, BBM	Silver alloy	Front & Top	90° key	Mechanical latch with over-ride	24 Vdc	Nitrile seals
GKRE44L7A4	Head to right	0.5-14 NPT	2NC/2NO slow action, BBM	2NC/2NO slow action, BBM	Silver alloy	Front & Top	90° key	Mechanical latch with over-ride	120 Vac	Nitrile seals
GKRE44L7S4	Head to right	0.5-14 NPT	2NC/2NO slow action, BBM	2NC/2NO slow action, BBM	Silver alloy	Front & Top	90° key	Solenoid latch with over-ride	120 Vac	Nitrile seals
GKRE44L8A2	Head to right	0.5-14 NPT	2NC/2NO slow action, BBM	2NC/2NO slow action, BBM	Silver alloy	Front & Top	Spring-loaded, up-down	Mechanical latch with over-ride	24 Vdc	Nitrile seals
GKRF44L8A2	Head to right	PG 13,5	2NC/2NO slow action, BBM	2NC/2NO slow action, BBM	Silver alloy	Front & Top	Spring-loaded, up-down	Mechanical latch with over-ride	24 Vdc	Nitrile seals
GKRG44L8A2	Head to right	20 mm	2NC/2NO slow action, BBM	2NC/2NO slow action, BBM	Silver alloy	Front & Top	Spring-loaded, up-down	Mechanical latch with over-ride	24 Vdc	Nitrile seals
GKRE44L8A4	Head to right	0.5-14 NPT	2NC/2NO slow action, BBM	2NC/2NO slow action, BBM	Silver alloy	Front & Top	Spring-loaded, up-down	Mechanical latch with over-ride	120 Vac	Nitrile seals
GKRE44L9A2	Head to right	0.5-14 NPT	2NC/2NO slow action, BBM	2NC/2NO slow action, BBM	Silver alloy	Front & Top	Spring-loaded, side-side	Mechanical latch with over-ride	24 Vdc	Nitrile seals
GKRF44L9A2	Head to right	PG 13,5	2NC/2NO slow action, BBM	2NC/2NO slow action, BBM	Silver alloy	Front & Top	Spring-loaded, side-side	Mechanical latch with over-ride	24 Vdc	Nitrile seals
GKRG44L9A2	Head to right	20 mm	2NC/2NO slow action, BBM	2NC/2NO slow action, BBM	Silver alloy	Front & Top	Spring-loaded, side-side	Mechanical latch with over-ride	24 Vdc	Nitrile seals
GKRE44L9A4	Head to right	0.5-14 NPT	2NC/2NO slow action, BBM	2NC/2NO slow action, BBM	Silver alloy	Front & Top	Spring-loaded, side-side	Mechanical latch with over-ride	120 Vac	Nitrile seals
GKRE44M7A4	Head to right	0.5-14 NPT	2NC/2NO slow action, BBM	2NC/2NO slow action, BBM	Silver alloy	Right & Top	90° key	Mechanical latch with over-ride	120 Vac	Nitrile seals
GKRE44P6A4	Head to right	0.5-14 NPT	2NC/2NO slow action, BBM	2NC/2NO slow action, BBM	Silver alloy	Left & Top	Straight key	Mechanical latch with over-ride	120 Vac	Nitrile seals
GKRE44P6S4	Head to right	0.5-14 NPT	2NC/2NO slow action, BBM	2NC/2NO slow action, BBM	Silver alloy	Left & Top	Straight key	Solenoid latch with over-ride	120 Vac	Nitrile seals
GKRE16LXS4	Head to right	0.5-14 NPT	3NC/1NO slow action, BBM	1NC/1NO slow action, BBM	Silver alloy	Front & Top	–	Solenoid latch with over-ride	120 Vac	Nitrile seals
GKRF16L6A2	Head to right	PG 13,5	3NC/1NO slow action, BBM	1NC/1NO slow action, BBM	Silver alloy	Front & Top	Straight key	Mechanical latch with over-ride	24 Vdc	Nitrile seals
GKRG16L6A2	Head to right	20 mm	3NC/1NO slow action, BBM	1NC/1NO slow action, BBM	Silver alloy	Front & Top	Straight key	Mechanical latch with over-ride	24 Vdc	Nitrile seals
GKRG16L6S2	Head to right	20 mm	3NC/1NO slow action, BBM	1NC/1NO slow action, BBM	Silver alloy	Front & Top	Straight key	Solenoid latch with over-ride	24 Vdc	Nitrile seals
GKRG16L7A2	Head to right	20 mm	3NC/1NO slow action, BBM	1NC/1NO slow action, BBM	Silver alloy	Front & Top	90° key	Mechanical latch with over-ride	24 Vdc	Nitrile seals

MICRO SWITCH™ Solenoid Safety Interlock Switches, GKL/R Series

Table 4. GKR Safety Switch Order Guide (continued)

Catalog Listing	Body Style (includes 2 LEDS unless noted)	Conduit	Contacts, Switch 1 (key/gate monitor)	Contacts, Switch 2 (solenoid monitor)	Contact Material	Head Position (opening for key)	Key Style	Locking Type/Over-ride	Solenoid Voltage	Enclosure Seal Material
GKRG16L7S2	Head to right	20 mm	3NC/1NO slow action, BBM	1NC/1NO slow action, BBM	Silver alloy	Front & Top	90° key	Solenoid latch with over-ride	24 Vdc	Nitrile seals
GKRG16L9A4	Head to right	20 mm	3NC/1NO slow action, BBM	1NC/1NO slow action, BBM	Silver alloy	Front & Top	Spring-loaded, side-side	Mechanical latch with over-ride	120 Vac	Nitrile seals
GKRE46LXA2	Head to right	0.5-14 NPT	3NC/1NO slow action, BBM	3NC/1NO slow action, BBM	Silver alloy	Front & Top	–	Mechanical latch with over-ride	24 Vdc	Nitrile seals
GKRA46LXA4	Head to right	0.5-14 NPT	3NC/1NO slow action, BBM	3NC/1NO slow action, BBM	Silver alloy	Front & Top	–	Mechanical latch with over-ride	120 Vac	Fluorocarbon seals
GKRA46L6A4	Head to right	0.5-14 NPT	3NC/1NO slow action, BBM	3NC/1NO slow action, BBM	Silver alloy	Front & Top	Straight key	Mechanical latch with over-ride	120 Vac	Fluorocarbon seals
GKRE46L9A2	Head to right	0.5-14 NPT	3NC/1NO slow action, BBM	3NC/1NO slow action, BBM	Silver alloy	Front & Top	Spring-loaded, side-side	Mechanical latch with over-ride	24 Vdc	Nitrile seals
GKRE46MXA4	Head to right	0.5-14 NPT	3NC/1NO slow action, BBM	3NC/1NO slow action, BBM	Silver alloy	Right & Top	–	Mechanical latch with over-ride	120 Vac	Nitrile seals
GKRE46M6A4	Head to right	0.5-14 NPT	3NC/1NO slow action, BBM	3NC/1NO slow action, BBM	Silver alloy	Right & Top	Straight key	Mechanical latch with over-ride	120 Vac	Nitrile seals
GKRE46M7A4	Head to right	0.5-14 NPT	3NC/1NO slow action, BBM	3NC/1NO slow action, BBM	Silver alloy	Right & Top	90° key	Mechanical latch with over-ride	120 Vac	Nitrile seals
GKRE46P7A4	Head to right	0.5-14 NPT	3NC/1NO slow action, BBM	3NC/1NO slow action, BBM	Silver alloy	Left & Top	90° key	Mechanical latch with over-ride	120 Vac	Nitrile seals
GKRE36MXA2	Head to right	0.5-14 NPT	3NC/1NO slow action, BBM	3NC/1NO slow action, BBM	Gold-plated	Right & Top	–	Mechanical latch with over-ride	24 Vdc	Nitrile seals
GKRG36MXA2	Head to right	20 mm	3NC/1NO slow action, BBM	3NC/1NO slow action, BBM	Gold-plated	Right & Top	–	Mechanical latch with over-ride	24 Vdc	Nitrile seals
GKRE36MXS2	Head to right	0.5-14 NPT	3NC/1NO slow action, BBM	3NC/1NO slow action, BBM	Gold-plated	Right & Top	–	Solenoid latch with over-ride	24 Vdc	Nitrile seals
GKRE36PXA2	Head to right	0.5-14 NPT	3NC/1NO slow action, BBM	3NC/1NO slow action, BBM	Gold-plated	Left & Top	–	Mechanical latch with over-ride	24 Vdc	Nitrile seals
GKRE36PXS2	Head to right	0.5-14 NPT	3NC/1NO slow action, BBM	3NC/1NO slow action, BBM	Gold-plated	Left & Top	–	Solenoid latch with over-ride	24 Vdc	Nitrile seals
GKRE40LXA2	Head to right	0.5-14 NPT	4NC slow action	4NC slow action	Silver alloy	Front & Top	–	Mechanical latch with over-ride	24 Vdc	Nitrile seals
GKRA40LXA4	Head to right	0.5-14 NPT	4NC slow action	4NC slow action	Silver alloy	Front & Top	–	Mechanical latch with over-ride	120 Vac	Fluorocarbon seals

MICRO SWITCH™ Solenoid Safety Interlock Switches, GKL/R Series

Table 5. GKL/R Prewired Safety Switch Order Guide

Catalog Listing	Body Style (includes 2 LEDs unless noted)	Electrical Connection	Contacts, Switch 1 (key/gate)	Contacts, Switch 2 (solenoid monitor)	Contact Material	Head Position (opening for key)	Key Style	Modification	Locking Type/Over-ride	Solenoid Voltage	Enclosure Seal Material
GKLA14L6A2-FW	Head to left	Prewired 10-pin Mini style & 4-pin M12 connector	2NC/2NO snap action	1NC/1NO slow action, BBM	Silver alloy	Front & Top	Straight key	Green LED replaced with yellow LED	Mechanical latch with over-ride	24 Vdc	Fluorocarbon seals
GKLA14L9A2-FW	Head to left	Prewired 10-pin Mini style & 4-pin M12 connector	2NC/2NO snap action	1NC/1NO slow action, BBM	Silver alloy	Front & Top	Spring-loaded, side-side	Green LED replaced with yellow LED	Mechanical latch with over-ride	24 Vdc	Fluorocarbon seals
GKLA14M6A2-FW	Head to left	Prewired 10-pin Mini style & 4-pin M12 connector	2NC/2NO snap action	1NC/1NO slow action, BBM	Silver alloy	Right & Top	Straight key	Green LED replaced with yellow LED	Mechanical latch with over-ride	24 Vdc	Fluorocarbon seals
GKLA14M9A2-FW	Head to left	Prewired 10-pin Mini style & 4-pin M12 connector	2NC/2NO snap action	1NC/1NO slow action, BBM	Silver alloy	Right & Top	Spring-loaded, side-side	Green LED replaced with yellow LED	Mechanical latch with over-ride	24 Vdc	Fluorocarbon seals
GKLA14P6A2-FW	Head to left	Prewired 10-pin Mini style & 4-pin M12 connector	2NC/2NO snap action	1NC/1NO slow action, BBM	Silver alloy	Left & Top	Straight key	Green LED replaced with yellow LED	Mechanical latch with over-ride	24 Vdc	Fluorocarbon seals
GKLA14P6A4-FW	Head to left	Prewired 10-pin Mini & 5-pin Mini style connectors	2NC/2NO snap action	1NC/1NO slow action, BBM	Silver alloy	Left & Top	Straight key	Green LED replaced with yellow LED	Mechanical latch with over-ride	120 Vac	Fluorocarbon seals
GKLA15L6A2-FW	Head to left	Prewired 10-pin Mini style & 4-pin M12 connector	2NC/2NO snap action	1NC/1NO slow action, BBM	Gold-plated	Front & Top	Straight key	Green LED replaced with yellow LED	Mechanical latch with over-ride	24 Vdc	Fluorocarbon seals
GKLA15L9A2-FW	Head to left	Prewired 10-pin Mini style & 4-pin M12 connector	2NC/2NO snap action	1NC/1NO slow action, BBM	Gold-plated	Front & Top	Spring-loaded, side-side	Green LED replaced with yellow LED	Mechanical latch with over-ride	24 Vdc	Fluorocarbon seals
GKLA15M6A2-FW	Head to left	Prewired 10-pin Mini style & 4-pin M12 connector	2NC/2NO snap action	1NC/1NO slow action, BBM	Gold-plated	Right & Top	Straight key	Green LED replaced with yellow LED	Mechanical latch with over-ride	24 Vdc	Fluorocarbon seals
GKLA15M9A2-FW	Head to left	Prewired 10-pin Mini style & 4-pin M12 connector	2NC/2NO snap action	1NC/1NO slow action, BBM	Gold-plated	Right & Top	Spring-loaded, side-side	Green LED replaced with yellow LED	Mechanical latch with over-ride	24 Vdc	Fluorocarbon seals
GKLA15P6A2-FW	Head to left	Prewired 10-pin Mini style & 4-pin M12 connector	2NC/2NO snap action	1NC/1NO slow action, BBM	Gold-plated	Left & Top	Straight key	Green LED replaced with yellow LED	Mechanical latch with over-ride	24 Vdc	Fluorocarbon seals
GKLA15P6A4-FW	Head to left	Prewired 10-pin Mini & 5-pin Mini style connectors	2NC/2NO snap action	1NC/1NO slow action, BBM	Gold-plated	Left & Top	Straight key	Green LED replaced with yellow LED	Mechanical latch with over-ride	120 Vac	Fluorocarbon seals
GKLA2PXA2-F04	Head to left	Prewired 10-pin Mini style connector	2NC/2NO snap action	2NC/2NO snap action	Silver alloy	Left & Top	–	–	Mechanical latch with over-ride	24 Vdc	Fluorocarbon seals
GKLA40L6A2-F05	Head to left	Prewired 10-pin Mini style connector	4NC slow action	4NC slow action	Gold-plated	Front & Top	Straight key	–	Mechanical latch with over-ride	24 Vdc	Fluorocarbon seals
GKLA40L6A2-F05-C	Head to left	Prewired 10-pin Mini style connector	4NC slow action	4NC slow action	Gold-plated	Front & Top	Straight key	–	Mechanical latch with over-ride	24 Vdc	Fluorocarbon seals
GKLA40L9A2-F05-C	Head to left	Prewired 10-pin Mini style connector	4NC slow action	4NC slow action	Gold-plated	Front & Top	Spring-loaded, side-side	–	Mechanical latch with over-ride	24 Vdc	Fluorocarbon seals
GKLA40M9A2-F05-C	Head to left	Prewired 10-pin Mini style connector	4NC slow action	4NC slow action	Gold-plated	Right & Top	Spring-loaded, side-side	–	Mechanical latch with over-ride	24 Vdc	Fluorocarbon seals

MICRO SWITCH™ Solenoid Safety Interlock Switches, GKL/R Series

Table 5. GKL/R Prewired Safety Switch Order Guide (continued)

Catalog Listing	Body Style (includes 2 LEDs unless noted)	Electrical Connection	Contacts, Switch 1 (key/gate)	Contacts, Switch 2 (solenoid monitor)	Contact Material	Head Position (opening for key)	Key Style	Modification	Locking Type/Over-ride	Solenoid Voltage	Enclosure Seal Material
GKLA40PXA2-F05	Head to left	Prewired 10-pin Mini style connector	4NC slow action	4NC slow action	Gold-plated	Left & Top	–	–	Mechanical latch with over-ride	24 Vdc	Fluorocarbon seals
GKLA40P6A2-F05-C	Head to left	Prewired 10-pin Mini style connector	4NC slow action	4NC slow action	Gold-plated	Left & Top	Straight key	–	Mechanical latch with over-ride	24 Vdc	Fluorocarbon seals
GKRA14L6A2-FW	Head to right	Prewired 10-pin Mini style & 4-pin M12 connector	2NC/2NO snap action	1NC/1NO slow action, BBM	Silver alloy	Front & Top	Straight key	Green LED replaced with yellow LED	Mechanical latch with over-ride	24 Vdc	Fluorocarbon seals
GKRA14M6A2-FW	Head to right	Prewired 10-pin Mini style & 4-pin M12 connector	2NC/2NO snap action	1NC/1NO slow action, BBM	Silver alloy	Right & Top	Straight key	Green LED replaced with yellow LED	Mechanical latch with over-ride	24 Vdc	Fluorocarbon seals
GKRA14M6A4-FW	Head to right	Prewired 10-pin Mini & 5-pin Mini style connectors	2NC/2NO snap action	1NC/1NO slow action, BBM	Silver alloy	Right & Top	Straight key	Green LED replaced with yellow LED	Mechanical latch with over-ride	120 Vac	Fluorocarbon seals
GKRA14P6A2-FW	Head to right	Prewired 10-pin Mini style & 4-pin M12 connector	2NC/2NO snap action	1NC/1NO slow action, BBM	Silver alloy	Left & Top	Straight key	Green LED replaced with yellow LED	Mechanical latch with over-ride	24 Vdc	Fluorocarbon seals
GKRA14P9A2-FW	Head to right	Prewired 10-pin Mini style & 4-pin M12 connector	2NC/2NO snap action	1NC/1NO slow action, BBM	Silver alloy	Left & Top	Spring-loaded, side-side	Green LED replaced with yellow LED	Mechanical latch with over-ride	24 Vdc	Fluorocarbon seals
GKRA15L6A2-FW	Head to right	Prewired 10-pin Mini style & 4-pin M12 connector	2NC/2NO snap action	1NC/1NO slow action, BBM	Gold-plated	Front & Top	Straight key	Green LED replaced with yellow LED	Mechanical latch with over-ride	24 Vdc	Fluorocarbon seals
GKRA15M6A2-FW	Head to right	Prewired 10-pin Mini style & 4-pin M12 connector	2NC/2NO snap action	1NC/1NO slow action, BBM	Gold-plated	Right & Top	Straight key	Green LED replaced with yellow LED	Mechanical latch with over-ride	24 Vdc	Fluorocarbon seals
GKRA15M6A4-FW	Head to right	Prewired 10-pin Mini & 5-pin Mini style connectors	2NC/2NO snap action	1NC/1NO slow action, BBM	Gold-plated	Right & Top	Straight key	Green LED replaced with yellow LED	Mechanical latch with over-ride	120 Vac	Fluorocarbon seals
GKRA15P9A2-FW	Head to right	Prewired 10-pin Mini style & 4-pin M12 connector	2NC/2NO snap action	1NC/1NO slow action, BBM	Gold-plated	Left & Top	Spring-loaded, side-side	Green LED replaced with yellow LED	Mechanical latch with over-ride	24 Vdc	Fluorocarbon seals
GKRA40L6A2-F05-C	Head to right	Prewired 10-pin Mini style connector	4NC slow action	4NC slow action	Gold-plated	Front & Top	Straight key	–	Mechanical latch with over-ride	24 Vdc	Fluorocarbon seals
GKRA40L9A2-F05-C	Head to right	Prewired 10-pin Mini style connector	4NC slow action	4NC slow action	Gold-plated	Front & Top	Spring-loaded, side-side	–	Mechanical latch with over-ride	24 Vdc	Fluorocarbon seals
GKRA40MXA2-F05	Head to right	Prewired 10-pin Mini style connector	4NC slow action	4NC slow action	Gold-plated	Right & Top	–	–	Mechanical latch with over-ride	24 Vdc	Fluorocarbon seals
GKRA40M6A2-F05-C	Head to right	Prewired 10-pin Mini style connector	4NC slow action	4NC slow action	Gold-plated	Right & Top	Straight key	–	Mechanical latch with over-ride	24 Vdc	Fluorocarbon seals
GKRA40P9A2-F05-C	Head to right	Prewired 10-pin Mini style connector	4NC slow action	4NC slow action	Gold-plated	Left & Top	Spring-loaded, side-side	–	Mechanical latch with over-ride	24 Vdc	Fluorocarbon seals

MICRO SWITCH™ Solenoid Safety Interlock Switches, GKL/R Series

Figure 9. GKL/R Dimensions mm [in]**

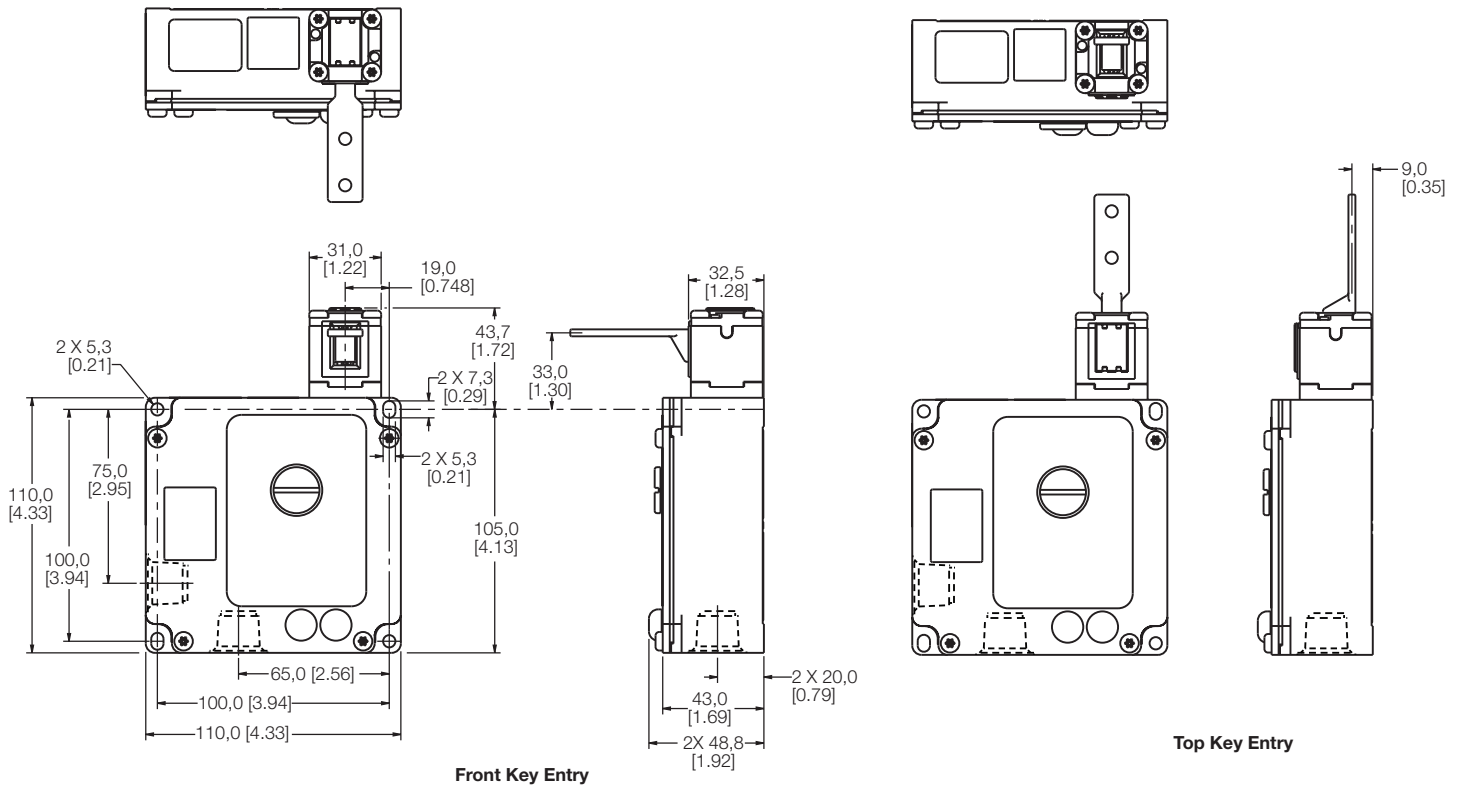

** GKR Series (head to right) illustrated for dimensions. GKL Series (head to left) similar, except head on left side.

MICRO SWITCH™ Solenoid Safety Interlock Switches, GKL/R Series

Figure 10. GKL/R Key Code 6 Dimensions mm [in]

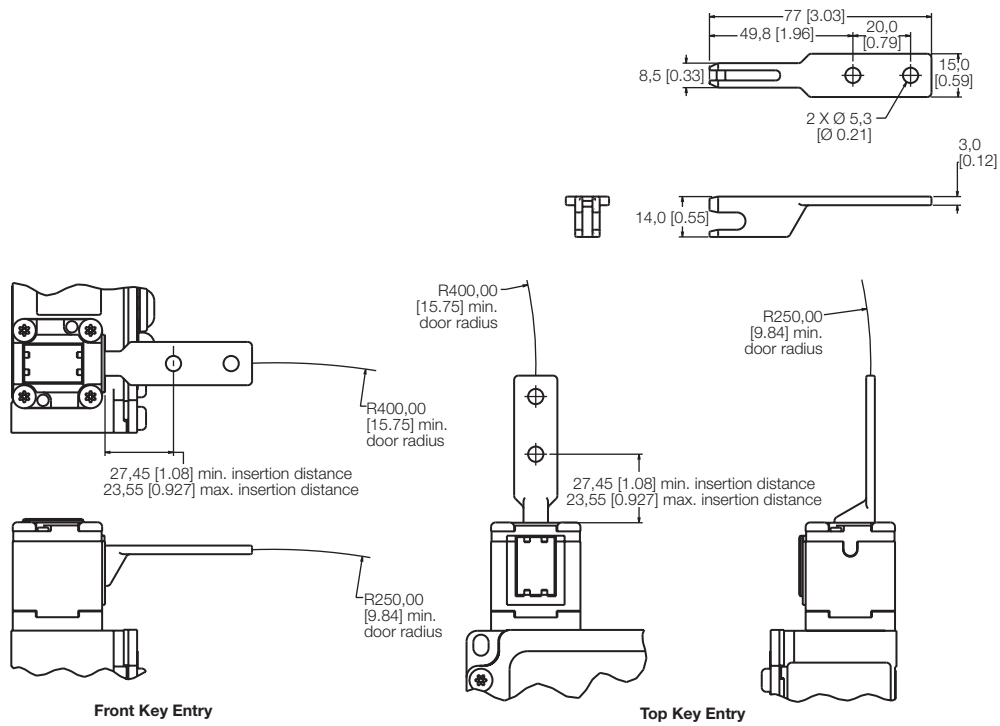
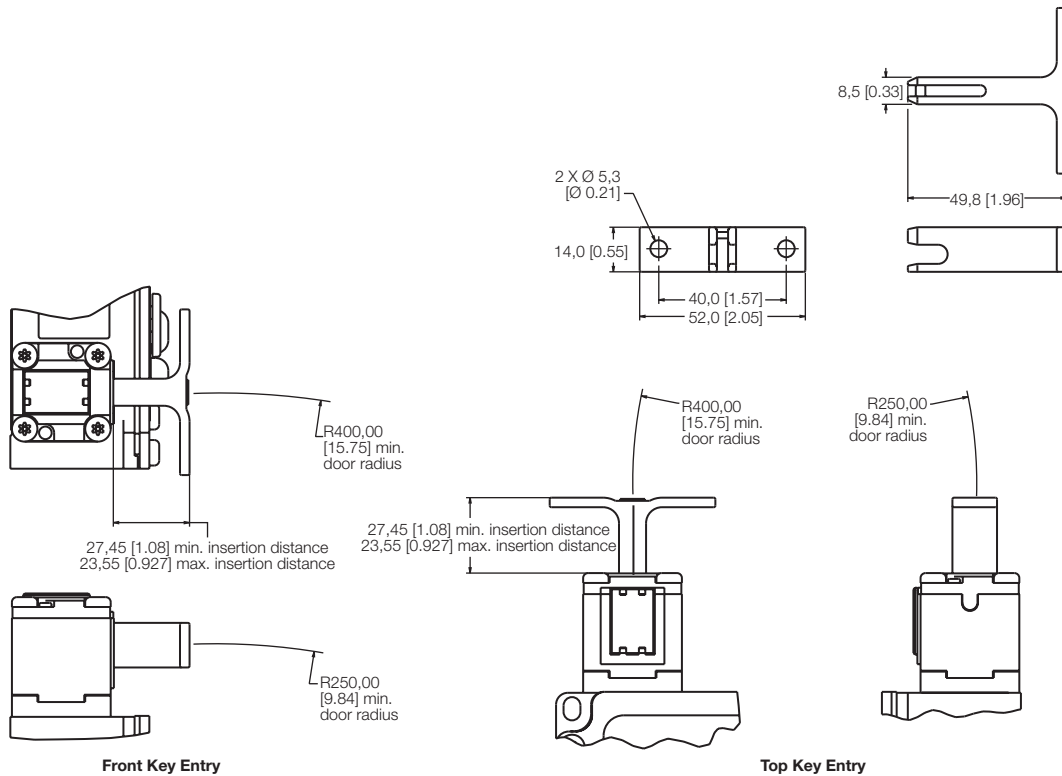

Figure 11. GKL/R Key Code 7 Dimensions mm [in]



MICRO SWITCH™ Solenoid Safety Interlock Switches, GKL/R Series

Figure 12. GKL/R Key Code 8 Dimensions mm [in]

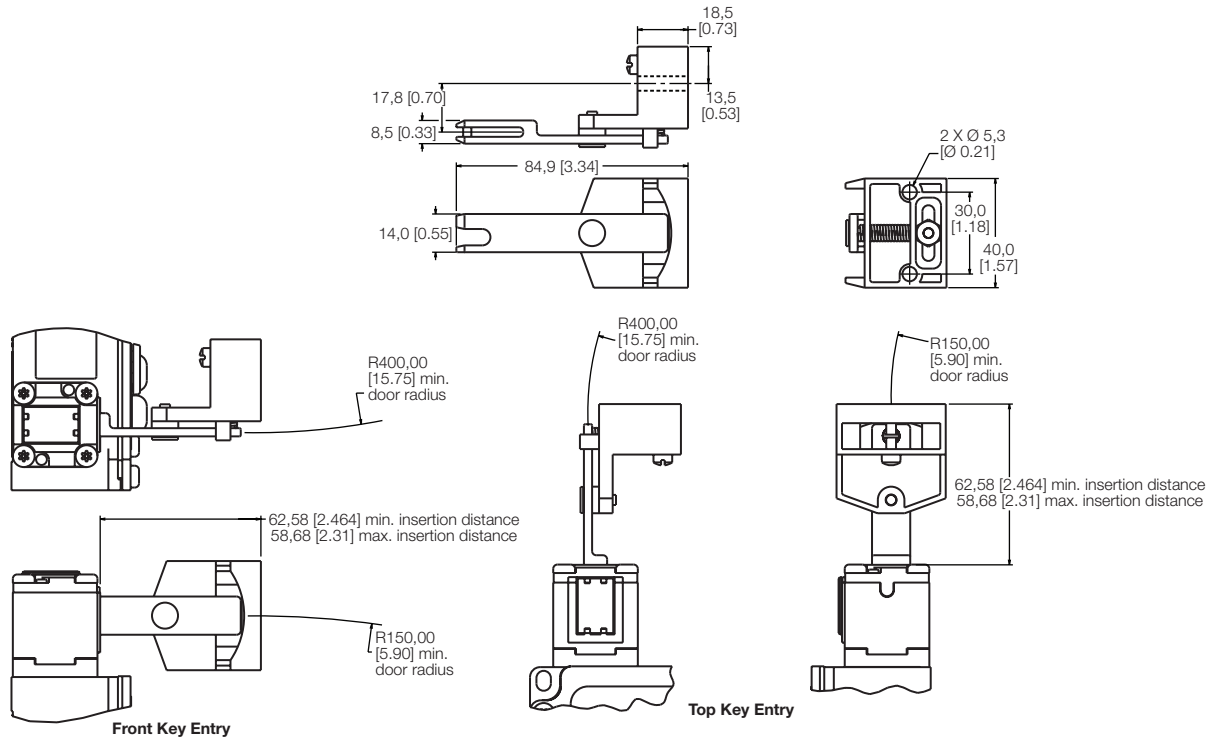
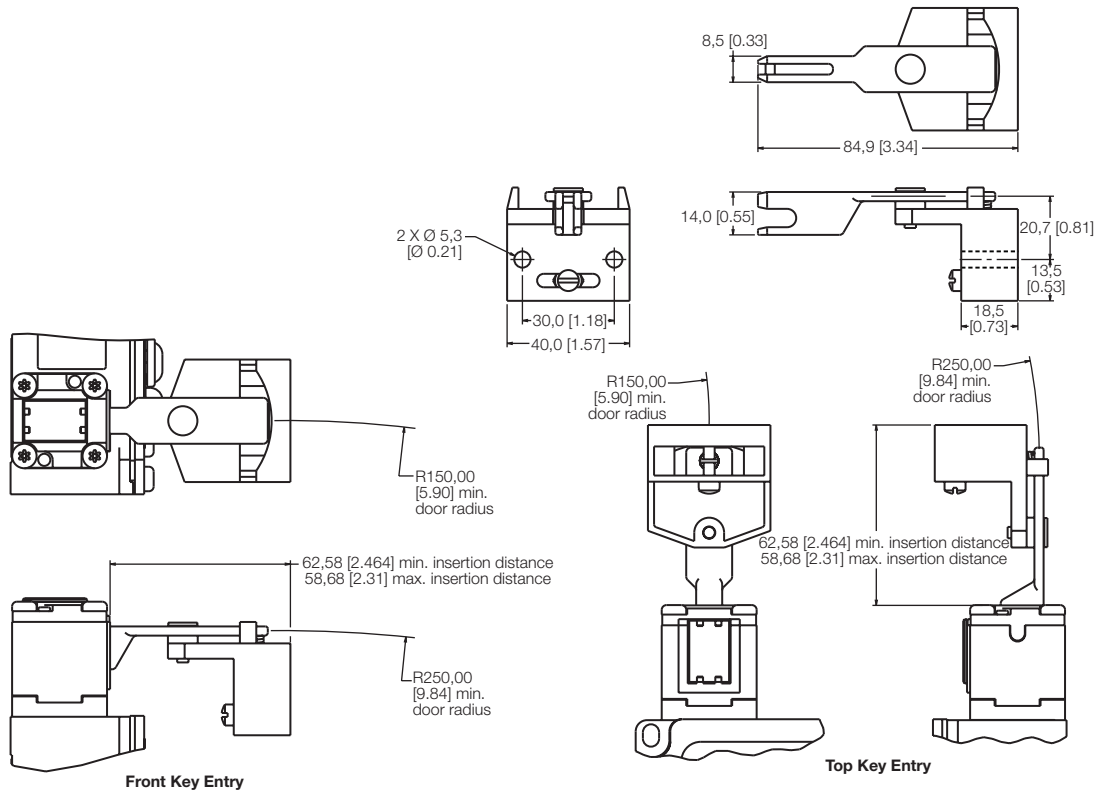

Figure 13. GKL/R Key Code 9 Dimensions mm [in]



MICRO SWITCH™ Solenoid Safety Interlock Switches, GKL/R Series

Figure 14. GK Series GKZL2 Lock-out Device mm [in]

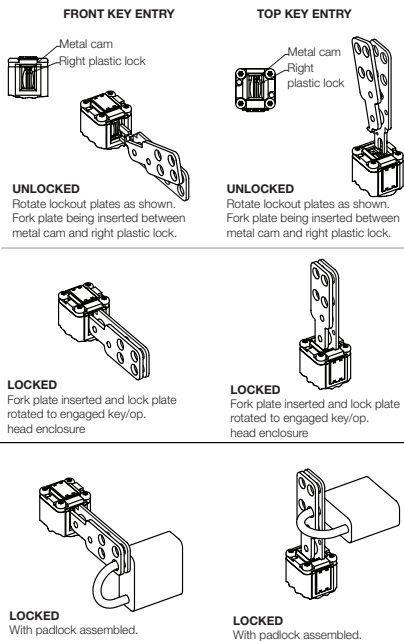
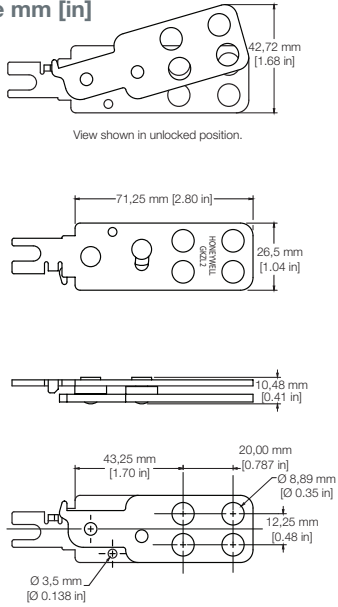

Figure 15. GK Series GKZ7 Safety Deadbolt Actuator mm [in]

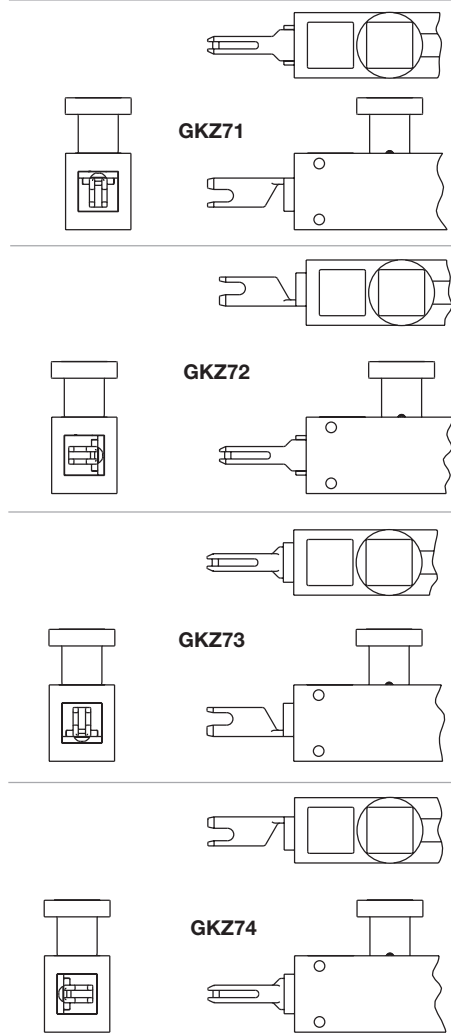
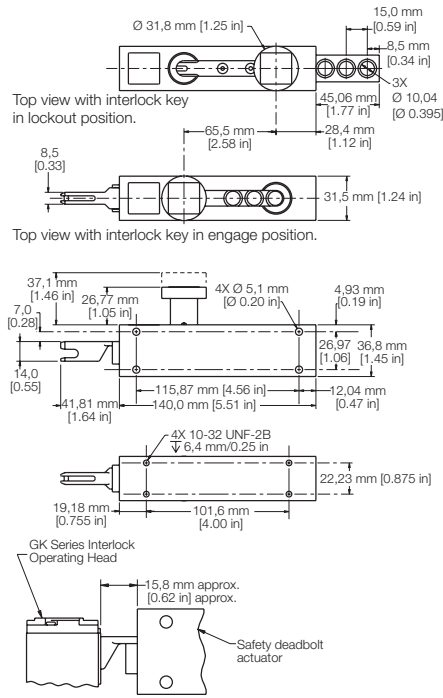

Table 6. Keys and Accessories

	Catalog Listing	Description
	GKZ56	Straight key
	GKZ57	90° key
	GKZ58	Spring loaded up/down
	GKZ59	Spring loaded side-to-side
	GKZL2	Lockout device
	GKZ71	Safety deadbolt actuator with key [0° ref.]
	GKZ72	Safety deadbolt actuator with key [90° ref.]
	GKZ73	Safety deadbolt actuator with key [180° ref.]
	GKZ74	Safety deadbolt actuator with key [270° ref.]
	GKZT-15BIT*	Torx T-15 security bit for cover screws

* A security bit is included with each switch.

ADDITIONAL MATERIALS

The following associated literature is available on the Honeywell web site at sensing.honeywell.com:

- Product installation instructions
- Product range guide
- Product line guide

Find out more

Honeywell serves its customers through a worldwide network of sales offices, representatives and distributors. For application assistance, current specifications, pricing or name of the nearest Authorized Distributor, contact your local sales office. To learn more about Honeywell's sensing and switching products, call **+1-815-235-6847** or **1-800-537-6945**, visit **sensing.honeywell.com**, or e-mail inquiries to **info.sc@honeywell.com**

Honeywell Sensing and Productivity Solutions

9680 Old Bailes Road
Fort Mill, SC 29707
honeywell.com

004789-1-EN IL50 GLO
March 2016
© 2016 Honeywell International Inc. All rights reserved.

WARNING **RISK TO LIFE OR PROPERTY**

Never use this product for an application involving serious risk to life or property without ensuring that the system as a whole has been designed to address the risks, and that this product is properly rated and installed for the intended use within the overall system.

Failure to comply with these instructions could result in death or serious injury.

WARNING **MISUSE OF DOCUMENTATION**

- The information presented in this product sheet is for reference only. Do not use this document as a product installation guide.
- Complete installation, operation, and maintenance information is provided in the instructions supplied with each product.

Failure to comply with these instructions could result in death or serious injury.

Warranty/Remedy

Honeywell warrants goods of its manufacture as being free of defective materials and faulty workmanship. Honeywell's standard product warranty applies unless agreed to otherwise by Honeywell in writing; please refer to your order acknowledgement or consult your local sales office for specific warranty details. If warranted goods are returned to Honeywell during the period of coverage, Honeywell will repair or replace, at its option, without charge those items it finds defective. **The foregoing is buyer's sole remedy and is in lieu of all other warranties, expressed or implied, including those of merchantability and fitness for a particular purpose. In no event shall Honeywell be liable for consequential, special, or indirect damages.**

While we provide application assistance personally, through our literature and the Honeywell web site, it is up to the customer to determine the suitability of the product in the application.

Specifications may change without notice. The information we supply is believed to be accurate and reliable as of this printing. However, we assume no responsibility for its use.

Honeywell