



Datasheet

RS PRO 3 Cell 2000 mA Battery Pack Charger for Lithium-Ion Batteries, AUS, EURO, UK & USA Plug

Stock number: 173-5590

EN



Technical Drawing:

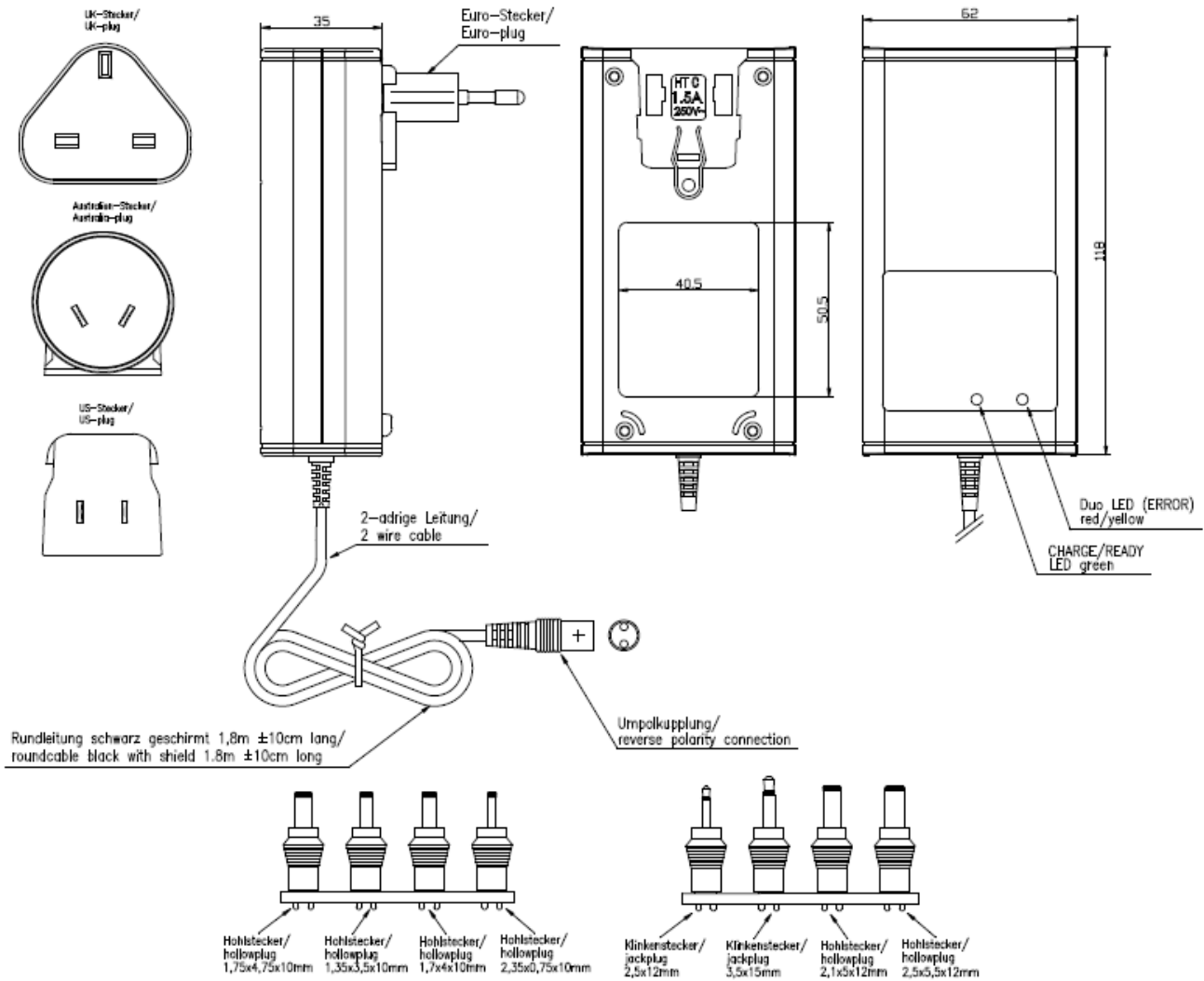

Charging Indicators:

No Battery	LEDs Off
Charging	Green LED Flashes
Battery Fully Charged	Green LED Lights Steady
Error	Red LED Flashes

Electrical Specifications:

Chemistry Charged	Lithium-Ion	Charging Regime	CC-CV
Input Voltage	100-240 V \pm 10%, 50/60 Hz	Primary Electrical Protection	Fuse 1.6 A
Nominal Output Voltage	11.1 V	Secondary Electrical Protection	Short Circuit and Wrong Polarity
Nominal Output Current	2000 mA \pm 10%	No Load Output Voltage	Approx. 8 V to 16.8 V
Number of Cells Charged	3	Electric Strength	4 kV Primary/Secondary
Charge End Voltage	12.6 V \pm 1%	Protection Class	II
Charge End Current	200 mA \pm 10%	Stand-By Power	< 0.8 W
Pre-Charge Current	50 mA to 500 mA \pm 20%	Leakage Current	< 100 μ A
Pre-Charge Voltage	2.5 V to 3 V per cell	Safety Timer	No
Restart Voltage	3.9 V to 4.1 V per cell	Approvals	CE
Reverse Current without AC	< 500 μ A at 4.2 V per cell	Standards	IEC/EN60335-2-29, UL1310

Physical Specifications:

Case	Plug-In Housing	Output Connectors	Push On
Case Material	PC Plastic UL94V-0, black	Plug Type	UK, Euro, US, Australia
PCB Material	FR4	Weight	320 g
Dimensions	118 mm x 62 mm x 35 mm	Operating Temperature	0°C to 40°C
Rating Plate (Front and Back)	Silver label with black printing	Storage Temperature	-25°C to +70°C