



The **HPS IMPERATOR[®]** series of machine tool industrial molded control transformers are available with standard secondary fuse kits or optional accessories such as primary fuse kits and optional finger guard kits. This accessory kits instruction sheet details the standard and optional accessories available and examples of detailed assembly drawings.

If you have any questions regarding what accessories are available or are having any difficulty correctly installing these accessories, please contact HPS customer service or technical support in the U.S. at 1-866-705-4684 or in Canada at 1-888-798-8882.

Standard and Optional Accessory Kits Available

Standard Secondary Fuse Kits - supplied with each **HPS IMPERATOR[®]** transformer up to 1500VA (excluding PH750PG, PH1000PG, PH750MLI and PH1000MLI)

Kit P/N	Parts Included in Kit
SFK1	2 fuse clips, 2 mtg. screws, 4 voltage links, PHAK1 instruction sheet
SFK2	2 fuse clips, 2 mtg. screws, 6 voltage links, PHAK1 instruction sheet
SFK3	2 fuse clips, 2 mtg. screws, 6 voltage links, PHAK1 instruction sheet
SFK4	2 fuse clips, 2 mtg. screws, 2 voltage links, PHAK1 instruction sheet
SFK5	2 fuse clips, 2 mtg. screws, 2 voltage links, PHAK1 instruction sheet
SFK6	2 fuse clips, 2 mtg. screws, 3 voltage links, PHAK1 instruction sheet
SFK7	2 fuse clips, 2 mtg. screws, 3 voltage links, PHAK1 instruction sheet

Optional Primary Fuse Kits

Kit P/N	Applicable P/N Suffix's	Applicable VA Size	Parts Included in Kit
PFK1	AJ, AR, MQMJ, QR, SP, PG, PP	50, 75, 100	4 fuse clips, 4 mtg. screws, PHAK1 instruction sheet
PFK2	AJ, AR, MQMJ, QR, SP, PG, PP	150, 250	4 fuse clips, 4 mtg. screws, PHAK1 instruction sheet
PFK3	AJ, AR, MQMJ, QR, SP, PG, PP	350 to 1500	4 fuse clips, 4 mtg. screws, PHAK1 instruction sheet
PFK4	MBMH, MEMX, MGJ, MLI	50	4 fuse clips, 4 mtg. screws, 1 jumper, 1 finger guard, PHAK1 instruction sheet
PFK5	MBMH, MEMX, MGJ, MLI	75	4 fuse clips, 4 mtg. screws, 1 jumper, 1 finger guard, PHAK1 instruction sheet
PFK5	MEMX, MGJ, MLI	100	4 fuse clips, 4 mtg. screws, 1 jumper, 1 finger guard, PHAK1 instruction sheet
PFK6	MBMH	100	4 fuse clips, 4 mtg. screws, 1 jumper wire, PHAK1 instruction sheet
PFK6	MBMH, MEMX, MGJ, MLI	150, 250	4 fuse clips, 4 mtg. screws, 1 jumper wire, PHAK1 instruction sheet
PFK7	MBMH, MEMX, MGJ, MLI	350 to 1500	4 fuse clips, 4 mtg. screws, 1 jumper wire, PHAK1 instruction sheet
N/A	N/A	2000 to 5000	

Optional Unfused Finger Guard Kits

Kit P/N	Applicable P/N Suffix's	Applicable VA Size	Parts Included in Kit
FG1	AJ, AR, MQMJ, MEMX, QR, SP, PG, PP	50	1 finger guard (unfused), PHAK1 instruction sheet
FG2	MBMH, MGJ, MLI	50	1 finger guard (unfused), PHAK1 instruction sheet
FG2	All	75	1 finger guard (unfused), PHAK1 instruction sheet
FG2	All (excluding PH100MBMH)	100	1 finger guard (unfused), PHAK1 instruction sheet
	refer to FG3, FG4 or FG5 below	150 to 1500	
N/A	All	2000 to 5000	

Optional Fused Finger Guard Kits

Kit P/N	Applicable P/N Suffix's	Applicable VA Size	Parts Included in Kit
FGF1	AJ, AR, MQMJ, MEMX, QR, SP, PG, PP	50	1 finger guard (fused), PHAK1 instruction sheet
FGF2	MBMH, MGJ, MLI	50	1 finger guard (fused), PHAK1 instruction sheet
FGF2	All	75	1 finger guard (fused), PHAK1 instruction sheet
FGF2	All (excluding PH100MBMH)	100	1 finger guard (fused), PHAK1 instruction sheet
FG3	MBMH	100	1 finger guard, PHAK1 instruction sheet
FG3	All	150	1 finger guard, PHAK1 instruction sheet
FG3	AJ, AR, MQMJ, MEMX, QR, SP, PG, PP	250	1 finger guard, PHAK1 instruction sheet
FG4	MBMH, MGJ, MLI	250	1 finger guard, PHAK1 instruction sheet
FG4	All	350, 500	1 finger guard, PHAK1 instruction sheet
FG4	AJ, AR, MQMJ, QR, SP, PP	750	1 finger guard, PHAK1 instruction sheet
FG5	MBMH, MEMX, MGJ, MLI, PG	750	1 finger guard, PHAK1 instruction sheet
FG5	All	1000, 1500	1 finger guard, PHAK1 instruction sheet
N/A	All	2000 to 5000	

Important Installation Notes:

- 1) Torque all terminal screws between 12 to 14 inch-lbs.
- 2) For all bare wire connections, the recommended wire size range is: 18 AWG to 14 AWG for solid wire and 14 AWG for stranded. A ring or spade connector must be used if using a wire size outside the range listed above.
- 3) Ensure mounting screws used for installation (screws not supplied), are properly sized for transformer weight and mounting application.
- 4) When mounting fuse clips, remove the appropriate captive washer screw(s) from terminal block and install fuse clip(s) and new terminal screw(s).
- 5) For connection details, please refer to wiring instructions supplied with your HPS IMPERATOR machine tool industrial control transformer.
- 6) Primary and secondary fuse kits are not suitable for *branch circuit* applications!



Accessory Sample Identifier Drawings

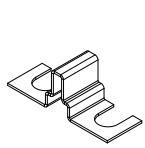

Voltage Link

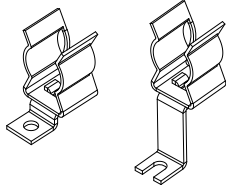

Fuse Clips
(for 50, 75 and 100VA)

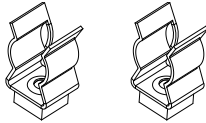

Fuse Clips
(for 150VA to 1500VA)

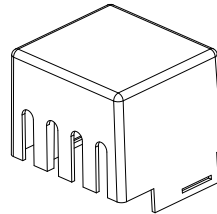

Finger Guard
(for 50, 75 and 100VA)

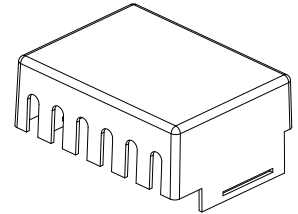

Finger Guard
(for 150VA to 1500VA)

Sample Assembly Drawings for Voltage Link Installation

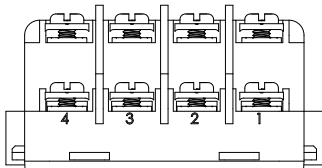
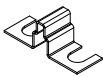

For units from 50VA to 100VA, the voltage links supplied can be installed between any two primary or secondary terminal bays. Please refer to PHWD1 or PHWD2 instruction sheet included with your transformer for connection details.

Style A (left) Style B (center) Style A (right)

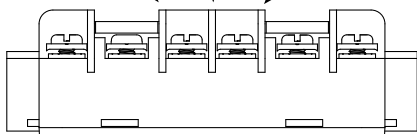
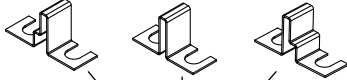

For units from 150VA to 250VA, the voltage links supplied must be installed between the primary or secondary terminal bays as indicated above. Please refer to PHWD1 or PHWD2 instruction sheet included with your transformer for connection details.

Style A (left) Style B (center) Style A (right)

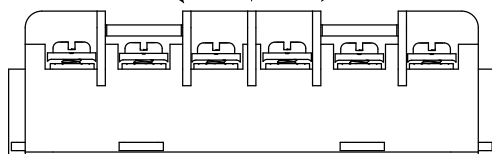
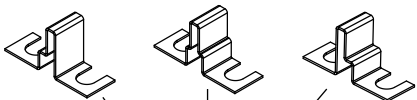

For units from 350VA to 1500VA, the voltage links supplied must be installed between the primary or secondary terminal bays as indicated above. Please refer to PHWD1 or PHWD2 instruction sheet included with your transformer for connection details.

Sample Assembly Drawing for Fuse Clip Installation (for 50, 75 and 100VA)

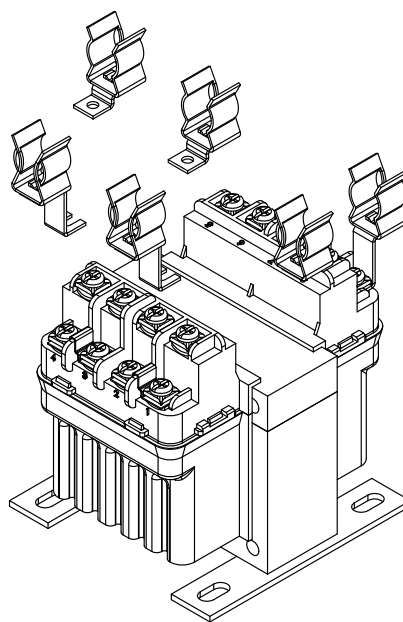

Sample Assembly Drawing for Fuse Clip Installation (for 150VA to 1500VA)

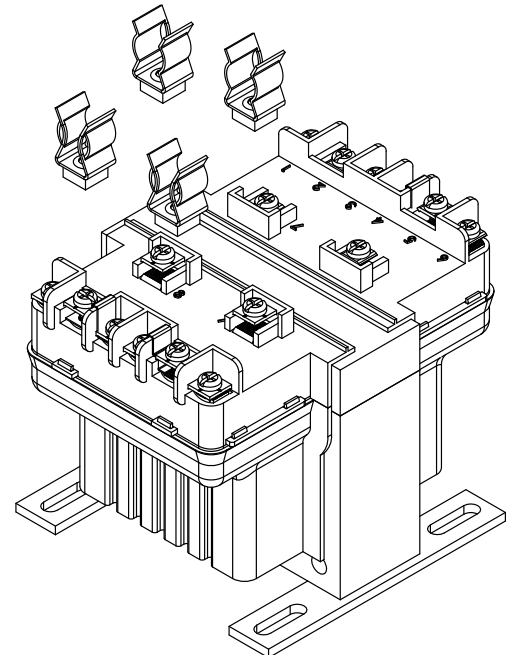

Sample Assembly Drawing for Finger Guard Installation (for 50, 75 and 100VA)

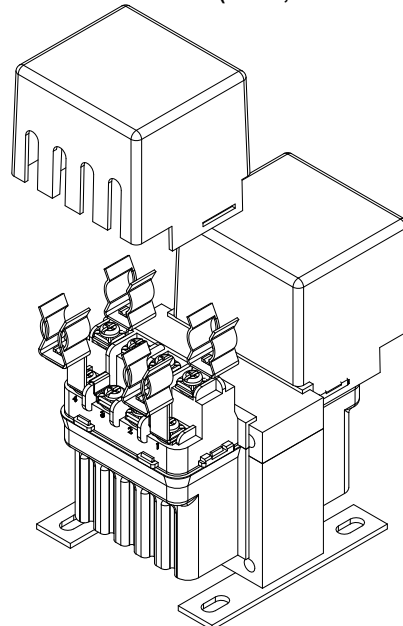

Sample Assembly Drawing for Finger Guard Installation (for 150VA to 1500VA)

