

C-7X

Description:

Smoothing chokes are power supply filter chokes having a core with an air gap which prevents saturation at maximum current. Hipot to 1500 VRMS between winding and core for safety.

Electrical Specifications (@25C):

Current DC M/A	Inductance †† Henries	Resistance Ohms
90.0	10.0	270

†† = Inductance tolerance -20%, + 50 %

Dimensions:

Unit: In inches

A	B	C	D
1.937	3.312	2.0	2.812

Weight: 1.30 lbs.

Schematic:

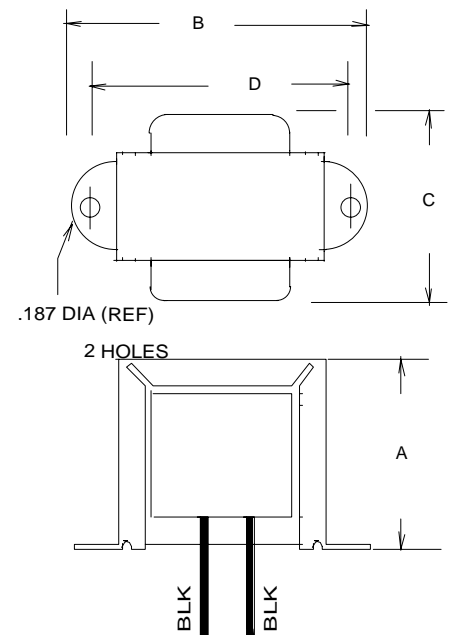
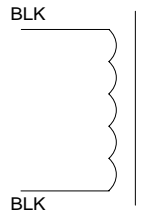

RoHS Compliance: As of manufacturing date February 2005, all standard products meet the requirements of 2011/65/EU, known as the RoHS initiative.

* Upon printing, this document is considered "uncontrolled". Please contact Triad Magnetics' website for the most current version