

Datasheet

RS Stock No. 1253557

RS Pro Long Life, High Performance Centrifugal Pump

Overview : Long Life, High Performance, Pump for Liquids

The M500 series range of pumps are driven by powerful brushless drive motors and can deliver unparalleled flow for their size. Constructed from precision CNC machined aluminium alloy with stainless steel tubing connectors and utilising a seal-less pump design as standard. Optional seals, wetted part coatings and materials are also available enabling this pump range to suit most applications and resist most chemicals and solvents.

The pump uses efficient push fit connectors designed for 8.0mm flexible tubing.

Pump Variants



M500S - Standard pump suitable for most applications

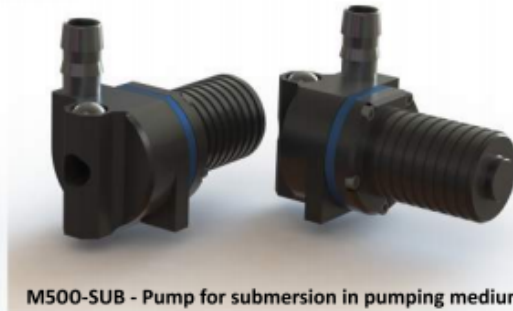

M500-SUB - Pump for submersion in pumping medium



M500-180 - Standard pump for inline flow connection

Note.

The M500 pump range utilize high performance efficient sensorless, brushless motor technology. These motors require a separate controller to operate and TCS Micropumps offer the EQ range of controllers for this purpose.

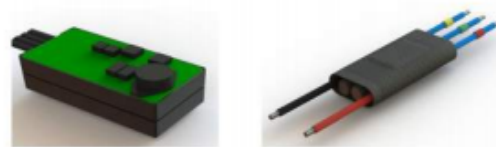

Typical Applications

- Medical devices
- Fuel Cells
- Battery and Solar Powered Systems
- Cooling Systems
- Low Pressure Fuel Pump
- Lubrication systems

Features

- Sealed waterproof design
- Sensorless, brushless drive motor
- CNC aluminium alloy construction
- Quiet pulseless smooth flow
- Small size only 64 x 32 x 31mm
- Weight 100g
- Free flow up to 10 litres per minute (water)
- Wide range of chemical resistance

Datasheet

RS Stock No. 1253557

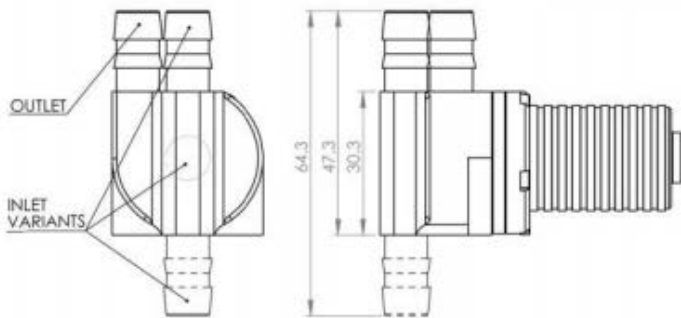
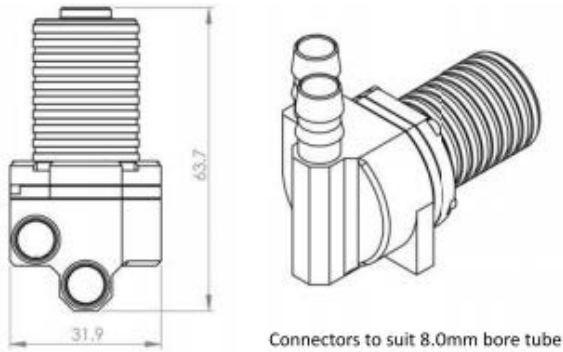

Materials

Wetted Parts

- Anodised 6000 Series Aluminium
- 316 Stainless Steel
- Viton
- Polyacetal

Other

- Materials typical to a Brushless Motor

Performance Data

- Small Size 64 x 32 x 31mm
- Weight 100 - 102 g
- Operating Temp -20 to 100 deg C
- Smooth Pulseless Flow
- IP Rating - Standard pumps IP67
- Noise Levels <15dB
Measured at a distance of 1m with a 50dB ambient noise level
- MTBF Stock Pumps 10,000hrs
Special variants available to order >100,000hrs

EQ12-M500

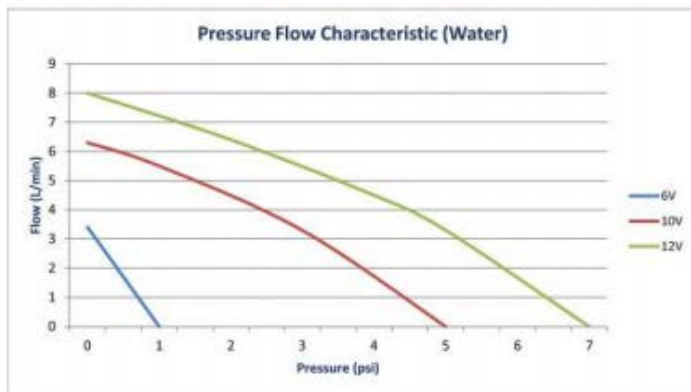

EQ24-M500

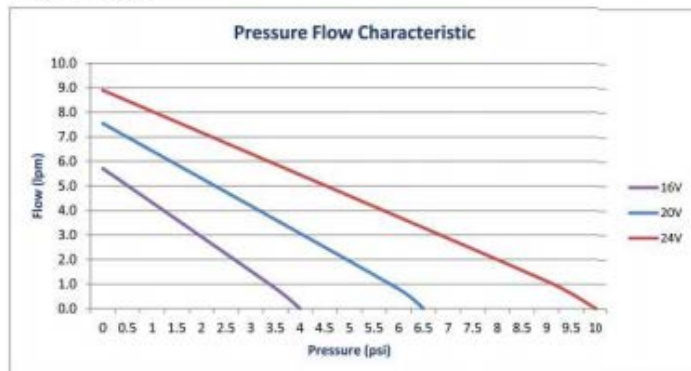

Variant	Input	Power	Flow	Pressure
	(v)	(w)	(lpm)	(psi)
EQ12-M500	6	4.2	3.8	1.5
	10	15	7.23	5.5
	12	22.8	8.75	8.5
EQ24-M500	16	11.2	5.7	4
	20	19	7.55	6.5
	24	28.8	8.9	10

(All M500 pump variants have the same performance)