

Datasheet

Quick Acting F LBC Fuse, 4A, 5x20mm

RS Stock number [668-5972](#)

GFE/GME

GFP/GMP-A



Specifications:

Materials

Glass body/nickel plated brass caps

Lead wire: Diameter \varnothing 0.8mm 14A and less

Diameter \varnothing 1.0mm for rating above 15A to 19A

Diameter \varnothing 1.2mm for rating above 20A

Interrupting Ratings

10mA~10A: 10,000 amperes at 125V ac

10mA~1A: 35 amperes at 250V ac

1.5A~3.5A: 100 amperes at 250V ac

3.75A~10A: 200 amperes at 250V ac

Operating Temperature

-55°C to + 125°C

Drawing (mm):

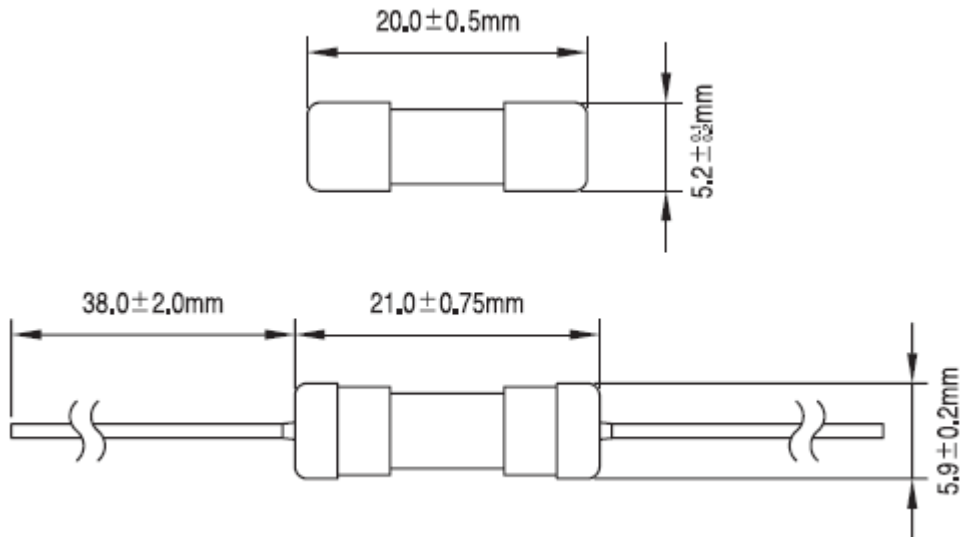

Electrical Characteristic:

Rated Current	1 In	1.35In	2 In
	MIN	MAX	MAX
10mA~20A	4 hr	1 hr	5 sec