

Professionally approved products.

Datasheet

Quick Acting F HBC Fuse, 1A, 5x20mm

RS Stock number [563-419](#)

UBM

UBM-A



Specifications:

Materials

Ceramic body/nickel plated brass caps

Lead wire: Diameter \varnothing 0.8mm 10A and less

Diameter \varnothing 1.0mm for rating above 12.5A

Interrupting Ratings

1500 amperes at 250V ac

Operating Temperature

-55°C to + 125°C

Professionally approved products.

Datasheet

Drawing (mm):

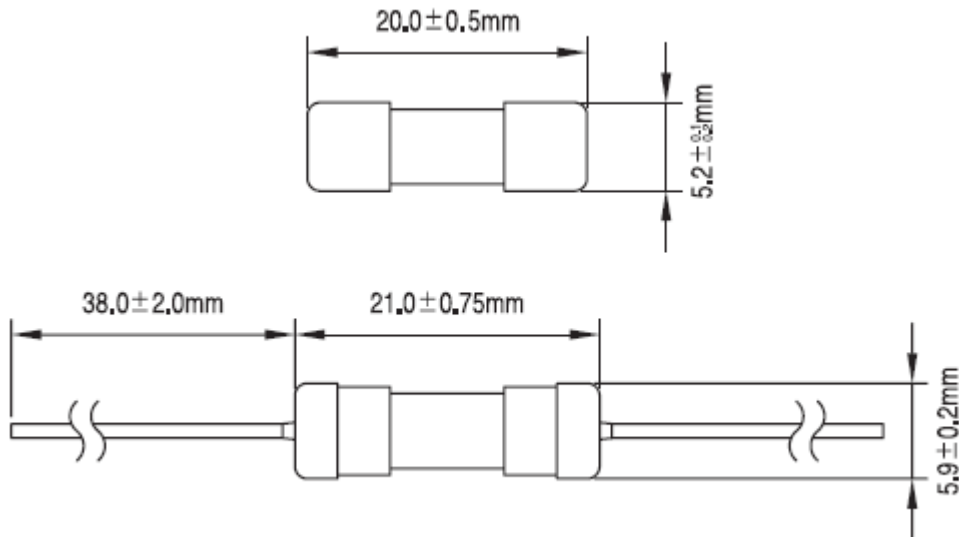

Electrical Characteristic:

Rated Current	1.5In	2.1In	2.75 In		4 In		10 In
	MIN	MAX	MIN	MAX	MIN	MAX	MAX
63mA~4A	60 min	30 min	10 ms	2 sec	3 ms	300 ms	20 ms
4A~6.3A	60 min	30 min	10 ms	3 sec	3 ms	300 ms	20 ms
8A~16A	30 min	30 min	40 ms	20 sec	10 ms	1 sec	30 ms