





















Datasheet

Red Panel Mount Female 3P+N+E Straight Industrial Power Socket Rated At 16A, 346 → 415 V

RS Stock number [464-1655](#)





Straight 75

Description		Colour	Pack qty.	Cat. no.
2P+⊥	4h 50/60Hz 100-130V		10/100	• 422.1660
	6h 50/60Hz 200-250V		10/100	• 422.1663
	9h 50/60Hz 380-415V		10/100	• 422.1668
16A 3P+⊥	4h 50/60Hz 100-130V		10/100	• 422.1661
	9h 50/60Hz 200-250V		10/100	• 422.1664
	6h 50/60Hz 380-415V		10/100	• 422.1666
	3h 50-60Hz 380/440V		10/100	• 422.16664
	4h 50/60Hz 100-130V		10/100	• 422.1662
	3P+N+⊥	9h 50/60Hz 208-250V		10/100
	6h 50/60Hz 346-415V		10/100	• 422.1667
2P+⊥	4h 50/60Hz 100-130V		10/50	• 422.3260
	6h 50/60Hz 200-250V		10/50	• 422.3263
	9h 50/60Hz 380-415V		10/50	• 422.3268
32A 3P+⊥	4h 50/60Hz 100-130V		10/50	• 422.3261
	9h 50/60Hz 200-250V		10/50	• 422.3264
	6h 50/60Hz 380-415V		10/50	• 422.3266
	3h 50-60Hz 380/440V		10/50	• 422.32664
	4h 50/60Hz 100-130V		10/50	• 422.3262
	3P+N+⊥	9h 50/60Hz 208-250V		10/50
	6h 50/60Hz 346-415V		10/50	• 422.3267



Straight 62 (*)

Description		Colour	Pack qty.	Cat. no.
16A 2P+⊥	4h 50/60Hz 100-130V		10/100	422.1660/R
	6h 50/60Hz 200-250V		10/100	422.1663/R
	9h 50/60Hz 380-415V		10/100	422.1668/R

422.

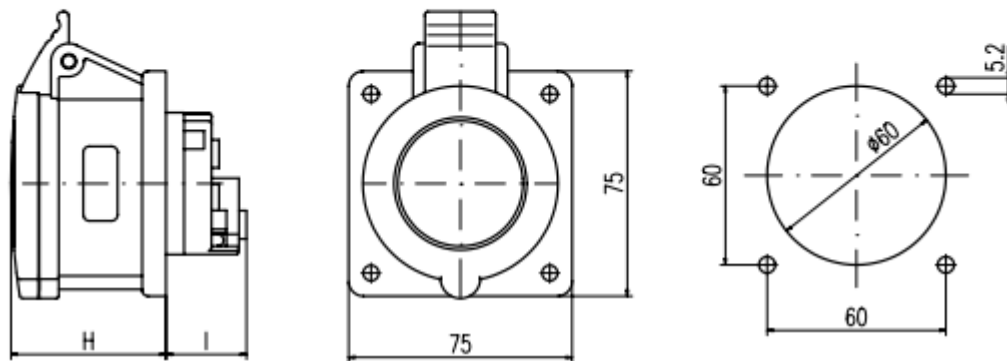

		I	H
16A	2P+ $\frac{1}{2}$	27	51
	3P+ $\frac{1}{2}$	27	51
	3P+N+ $\frac{1}{2}$	27	52
32A	2P+ $\frac{1}{2}$	42	62
	3P+ $\frac{1}{2}$	42	62
	3P+N+ $\frac{1}{2}$	42	63