

Professionally approved products.

Datasheet

Anti Surge T LBC Fuse, 250mA, 5x20mm

RS Stock number [563-738](#)

USL



USL-A



UTE



UTE-A



Specifications:

Materials

Glass body/nickel plated brass caps

Lead wire: Tin-lead plated copper, Diameter \varnothing 0.8mm.

Interrupting Ratings

35 amperes or 10 in rated current; whichever is greater.

Operating Temperature

-55°C to + 125°C

Professionally approved products.

Datasheet

Drawing (mm):

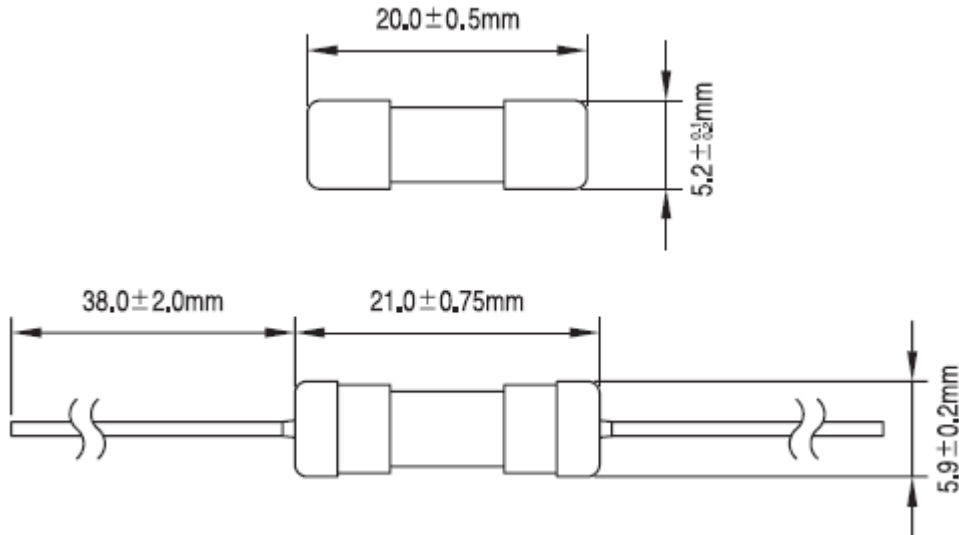

Electrical Characteristic:

Rated Current	1.5In		2.1In		2.75 In		4 In		10 In	
	MIN	MAX	MIN	MAX	MIN	MAX	MIN	MAX	MIN	MAX
63mA~100mA	60 min	2 min	200 ms	10 sec	40 ms	3 sec	10 ms	300 ms		
125mA~6.3A	60 min	2 min	600 ms	10 sec	150 ms	3 sec	20 ms	300 ms		
8A~10A	30 min	2 min	600 ms	10 sec	150 ms	3 sec	20 ms	300 ms		