

ABC450 Series

AC-DC Open Frame Power Supplies

The ABC450 Series of open-frame power supplies, with its wide universal 90-264 VAC input range and high power density, is available at 450 W of output power and a variety of single and multiple output voltages.

The high efficiency and high power density of the ABC family ensures minimal power loss in end-use equipment, thereby facilitating higher reliability, easier thermal management and meets regulatory approvals for environmentally-friendly end products.

These medical power supplies are ideal for monitoring, home health equipment as well as surgical devices.



Key Features & Benefits

- 4 x 6.5 x 1.61 inches
- Universal AC Input
- 450 W (with airflow), 300 W (without airflow)
- Current Sharing Option
- Cover and Fan Options
- Peak Power Capability
- Low Standby Power
- Side Fan or Top Fan Mounting Option Product
- (-S or -T to be added to model number)
- Current Sharing Option Product (-I to be added to model number)
- ITE Safety Agency Approvals
- RoHS Compliant
- CE marked

Applications

- Instrumentation
- Lighting
- Industrial Applications
- Test and Measurement
- Robotics
- Renewable Energy
- Data Communication
- Applied Computing



bel POWER
SOLUTIONS &
PROTECTION

a bel group

belfuse.com/power-solutions

1. MODEL SELECTION

MODEL	OUTPUT VOLTAGE	MAX LOAD (CONVECTION) ^{1,2,3}	MAX LOAD (420 LFM) ^{1,2,3}	MINIMUM LOAD	RIPPLE & NOISE ⁴
ABC450-1T05G	5 VDC	31.0 A	55.0 A	0.0 A	2%
ABC450-1T12G	12 VDC	20.83 A	37.5 A	0.0 A	2%
ABC450-1T15G	15 VDC	16.66 A	30.0 A	0.0 A	2%
ABC450-1T24G	24 VDC	12.30 A	18.75 A	0.0 A	2%
ABC450-1T30G	30 VDC	10.0 A	15.0 A	0.0 A	2%
ABC450-1T48G	48 VDC	6.25 A	9.37 A	0.0 A	2%

2. INPUT SPECIFICATIONS

Specifications are for nominal input voltage, 25°C unless otherwise stated.

PARAMETER	DESCRIPTION / CONDITION	SPECIFICATIONS
Input Voltage	Universal	90-264 VAC / 120-390 VDC
Input Frequency		47 to 63 Hz
Input Current	120 VAC: 230 VAC:	4.5 A max. 2.3 A max.
No Load Power	120 VAC: 230 VAC:	0.4 W 0.8 W
Inrush Current	120 VAC: 230 VAC:	40 A max. 75 A max.
Leakage Current	Earth Leakage Current Touch Leakage Current	270 µA 45 µA @120 VAC / 63 Hz
Input Protection	Dual fusing, in AC Line and AC Neutral	T8A / 250 V
Power Factor	120 VAC 230 VAC	0.98 0.95
Switching Frequency	PFC converter: Variable Resonant converter: Variable	45-160 kHz typical 35-250 kHz, 90 kHz typical

¹ Combined output power of main output, fan supply and standby supply shall not exceed max. power rating

² Standby output voltage 5 V / 1.5 A (convection) / 2 A (420LFM) with tolerance including set point accuracy, line and load regulation is +/-10%. Ripple and noise is less than 5%.

³ Fan supply output voltage 12 V / 500 mA with tolerance including set point accuracy, line and load regulation is +/-30% and needs min. 1% load on main output to be within regulation band. Ripple and noise is less than 10%.

⁴ Ripple is peak to peak with 20 MHz bandwidth and 10 µF (Tantalum capacitor) in parallel with a 0.1 µF capacitor at rated line voltage and load ranges. Please contact factory/ sales representative for minimum load required for ripple to be within specification.

3. OUTPUT SPECIFICATIONS

PARAMETER	DESCRIPTION / CONDITION	SPECIFICATIONS
Output Power ⁵	475 W for 24 V, 30 V & 500 W for 48 V model only for 5 seconds max.	155 to 450 W
Efficiency (Full Load)	120 VAC	24 V, 48 V, 30 V 88% 12 V, 15 V 86% 5 V 83% typical
	230 VAC	24 V, 48 V, 30 V 90%
Hold Up Time	120 / 230 VAC	10 ms
Line Regulation		+/-0.5%
Load Regulation		+/-3%
Transient Response	<10%, 50% to 100% load change, 50 Hz, 50% duty cycle, 0.1 A/ μ s	Recovery time < 5 ms
Rise Time		< 100 ms
Set Point Tolerance		+/-1%
Voltage Adjustment	V1	\pm 3 %
Over Voltage Protection	Latch Type	>114%
Over Current Protection	Hic-Up type	120 to 150%
Short Circuit Protection	Short term, auto recovery	
Over Temperature Protection	Automatic recovery	130°C primary heat sink
Current Share	Up to 2 supplies connected in parallel (optional)	

4. SIGNALS

PARAMETER	DESCRIPTION / CONDITION
Power Good Signal	TTL signal goes high after main output is within regulation band, delay is 0.1 to 0.3 s
Remote Sense	Compensates for 200 mV drop
Remote on/off	To turn on PSU short remote pin to ground

5. EMC SPECIFICATIONS

PARAMETER	DESCRIPTION / CONDITION	SPECIFICATION
Conducted Emissions	EN55032-B, CISPR22-B, FCC PART15-B	Pass
Radiated Emissions	EN 55032 A; with external core (King core K5B RC 25x12x15-M in input cable)	Pass Level B
Input Current Harmonics	EN 61000-3-2	Class D
Voltage Fluctuation and Flicker	EN 61000-3-3	Pass
ESD Immunity	EN 61000-4-2	Level 3, Criterion A
Radiated Field Immunity	EN 61000-4-3	Level 3, Criterion A
Electrical Fast Transient Immunity	EN 61000-4-4	Level 3, Criterion A
Surge Immunity	EN 61000-4-5	Level 3, Criterion A
Conducted Immunity	EN 61000-4-6	Level 3, Criterion A
Magnetic Field Immunity	EN 61000-4-8	Level 3, Criterion A
Voltage Dips, Interruptions	EN 61000-4-11	Criterion A & B

⁵ Derate output power linearly to 80% from 90 VAC to 80 VAC input.

6. ENVIRONMENTAL SPECIFICATIONS

PARAMETER	DESCRIPTION / CONDITION	SPECIFICATIONS
Operating Temperature	Refer to derating curve (<i>Figure 1</i>)	0 to +70°C
Storage Temperature		-40 to 85° C
Humidity	Non Condensing	95% HR
Altitude	Operating: Non-Operating:	10,000 ft. 40,000 ft.
Cooling	5 V model	Convection: 155 W 420 LFM: 275 W
	12 V & 15 V models	Convection: 250 W 420 LFM: 450 W
	24 V, 30 V & 48 V models	Convection: 300 W 420 LFM: 450 W
Reliability	MTBF according to Telcordia -SR332-Issue 3	1.28 million hours

7. SAFETY SPECIFICATIONS

PARAMETER	DESCRIPTION / CONDITION	SPECIFICATION
Isolation Voltage	Input to Output Input to Earth	4242 VDC 2121 VDC
Safety Standards	Approved to the latest edition of the following standards: CSA/UL60950-1, EN60950-1 and IEC60950-1; Class1 SELV	
Agency Approvals	Nemko, Nemko-CCL	
CE mark	Complies with LVD Directive	

8. CONNECTOR & PIN DESCRIPTION

CONNECTOR	PIN	DESCRIPTION / CONDITION	MANUFACTURER / PN
AC Input Connector	J1	Pin 1 AC line Pin 3 AC neutral Pin 5 Earth	Tyco: 1-1123724-3 Mating: 1-1123722-5
DC Output Connector	J2	Lug 1 +V1 Lug 2 RTN	6-32 inches Screw Pan HD Mating: 16 AWG wire crimped to Ring Tongue Terminal AMP: 8-31886-1
Signals ⁶	J3	Pin 1 NC Pin 2 Power Fail Pin 3 Power Good Pin 4 DC Return Pin 5 +5Vstby Pin 6 +VE Remote Sense Pin 7 -VE Remote Sense Pin 8 CS Pin 9 DC Return Pin 10 Remote On/Off	Molex: 22-23-2081 Mating: 22-01-2087; Pins: 08-50-0113
Fan	J4	Pin 1 +VE Pin 2 -VE	Mating Connector: Molex 22-01-2025 Pins = 08-50-0113
Earth ⁷	J5		Molex: 19705-4301 Mating: 190030001

⁶ PSU is supplied with J3, pin-9 and pin-10 shorted to enable main output without remote on/off feature

⁷ The J5 (Earth) spade connector can be used for U-Channel option products only. When fan options are required the earth connection provided in the input AC connector should be used (Pin 5 – J1)

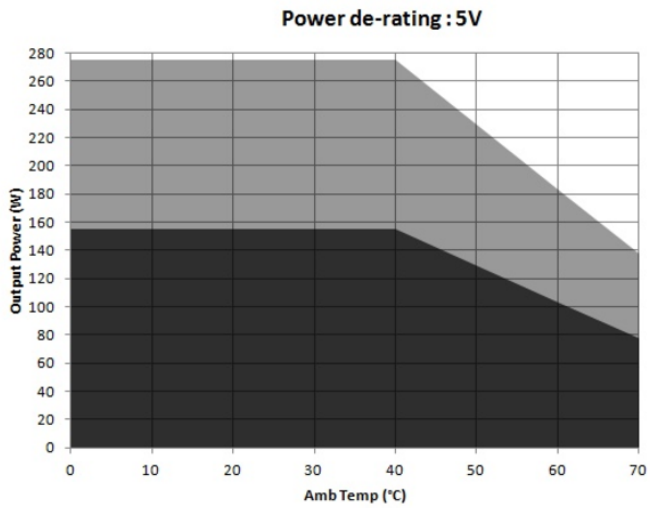

Convection load: 155 W up to 40 °C
De-rate above 40 °C @ 1.67% per °C

Forced air cooled load: 275 W up to 40°C
De-rate above 40 °C @ 1.67% per °C

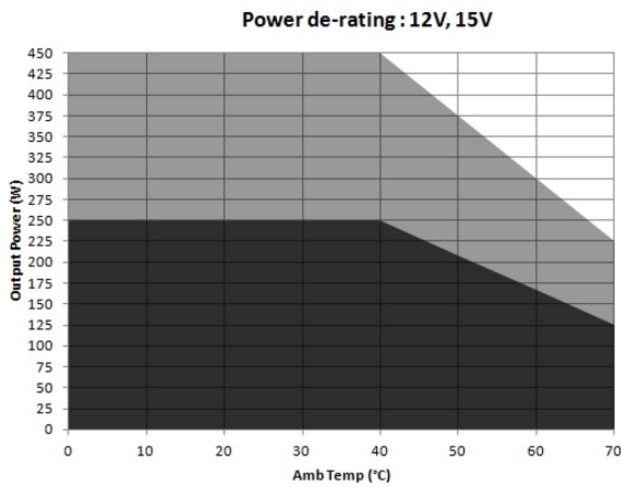

Convection load: 250 W up to 40 °C
De-rate above 40 °C @ 1.67% per °C

Forced air cooled load: 450 W up to 40°C
De-rate above 40 °C @ 1.67% per °C

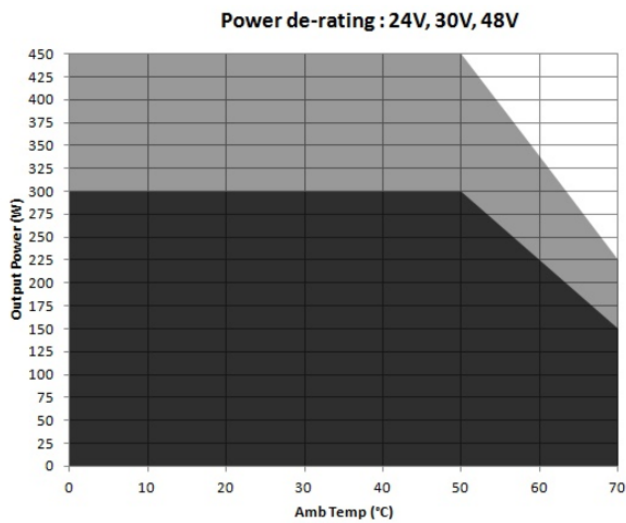

Convection load: 300 W up to 50 °C
De-rate above 50 °C @ 2.5% per °C

Forced air cooled load: 450 W up to 50°C
De-rate above 50 °C @ 2.5% per °C

Figure 1. Derating Curves



Asia-Pacific
+86 755 298 85888

Europe, Middle East
+353 61 225 977

North America
+1 408 785 5200

9. MECHANICAL SPECIFICATIONS

PARAMETER	DESCRIPTION / CONDITION
Weight	900 g (1.98 lbs)
Dimensions	101.6 x 165.0 x 41.0 mm (4.0 x 6.5 x 1.6 inch)

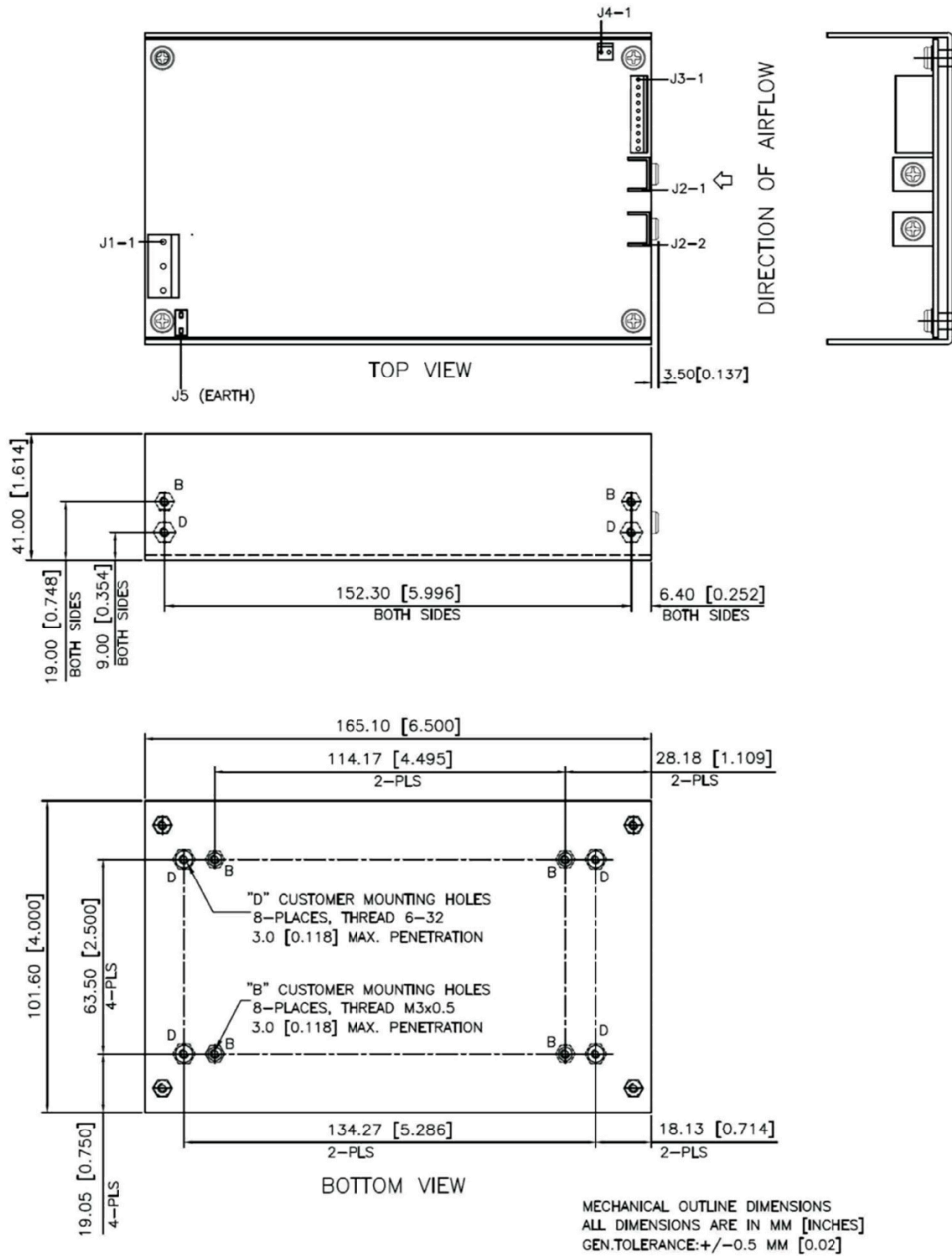

Figure 2. Mechanical Drawing (Without Fan Mounting)

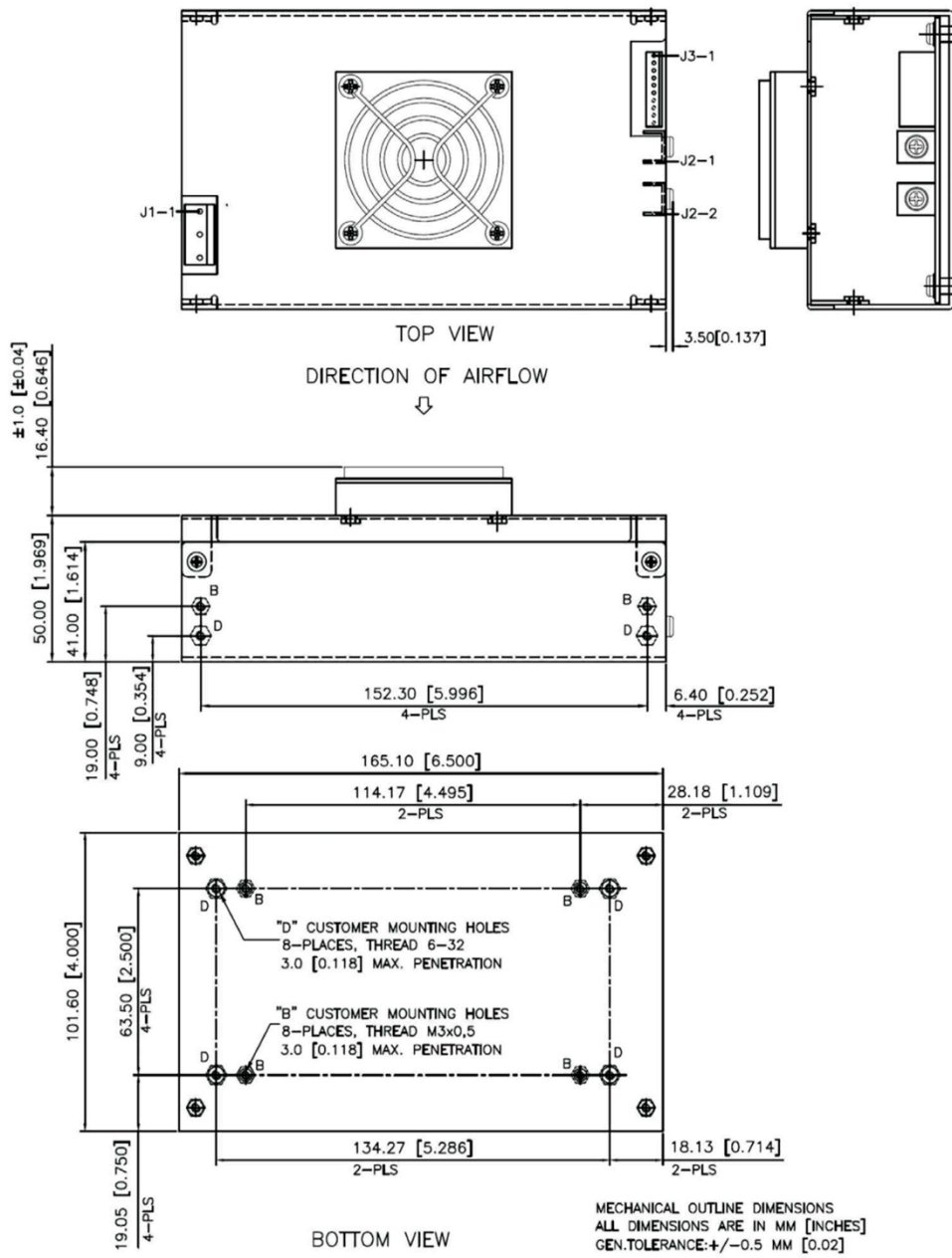

Figure 3 - Mechanical Drawing (With Top Fan Mounting)

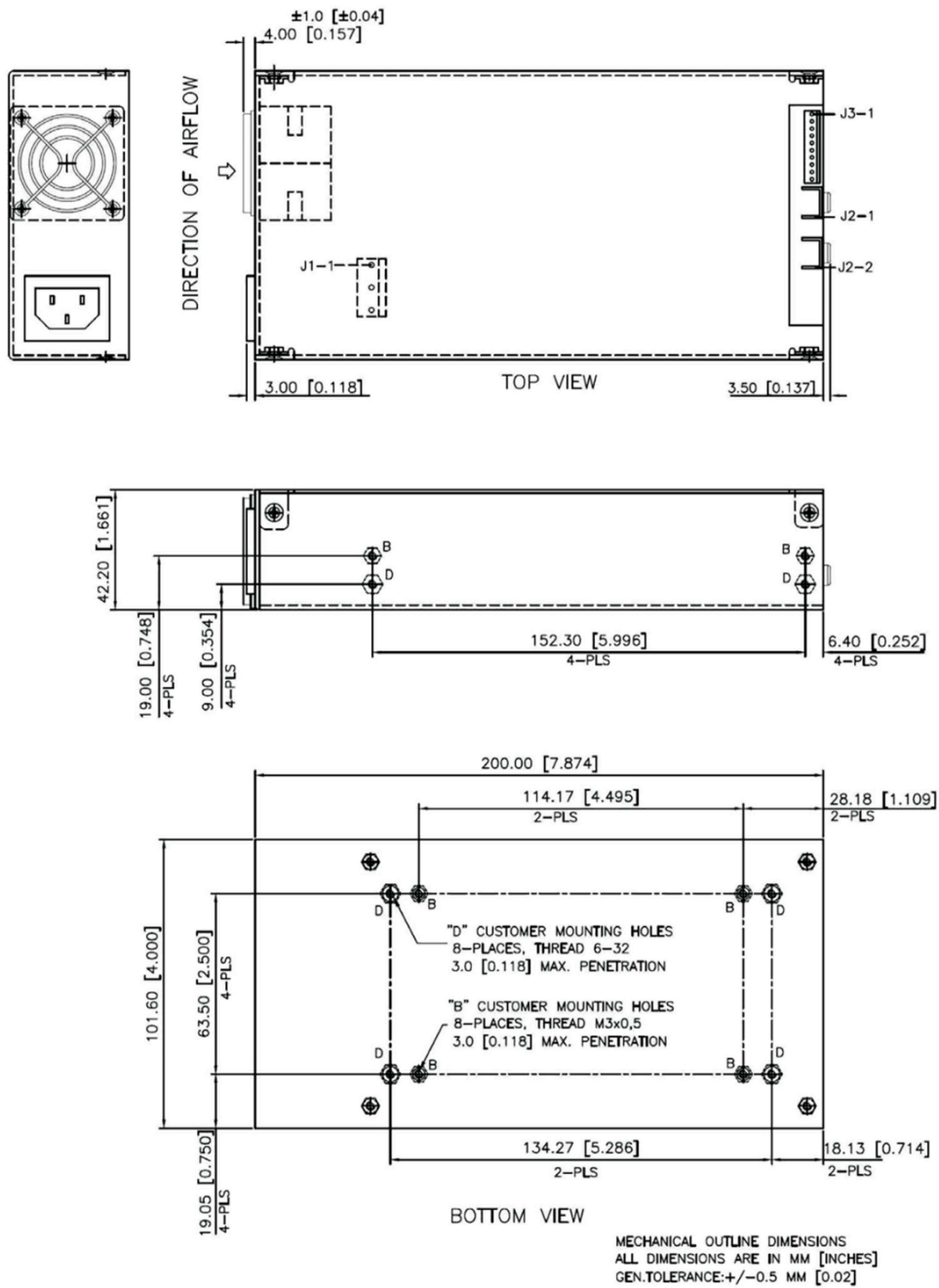

Figure 4 - Mechanical Drawing (With Side Fan Mounting)

10. INSTALLATION INSTRUCTION FOR CURRENT SHARING

During the installation and setup of parallel supplies in a system it is important that a single remote sense point be used for all the supplies.

The remote sense voltage between the supplies must be adjusted to within 2% to ensure the supplies are inside the 3% capture window.

If the supplies are not initially adjusted inside the capture window the supplies will not current share.

NOTE:

“CURRENT SHARING “ facility is inclusive with the unit only with ordering of the “ CURRENT SHARING “ option unit i.e. ABC450-1XXX-I or ABC450-1XXX-I.

SET-UP PROCEDURE:

- 1 Connect load cables to the outputs of each supply.
- 2 Connect the remote sense lines to the load in twisted style. (A common remote sense point must be used for all the supplies in parallel).
- 3 Connect all the “current share” pins on the J3 connector between the supplies.
- 4 Adjust remote sense voltage of each supply to within 1% of rated output voltage or readjust to required set point. (Adjustment to be done with all other parallel supplies off).
- 5 Current sharing between the supplies can be verified by monitoring the output current of each supply with a hall effect DC current probe. The supplies should share to within 10% of the total load current.
- 6 The current share circuit has a capture window voltage of +/- 3% of the rated output voltage. If the output remote sense voltage of one of the supplies is adjusted outside the 3% window the supplies will not current share.

CURRENT SHARING BLOCK DIAGRAM

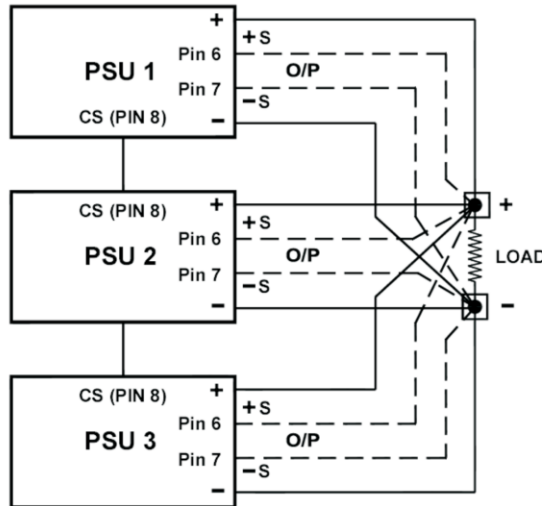

For more information on these products consult: tech.support@psbel.com

NUCLEAR AND MEDICAL APPLICATIONS - Products are not designed or intended for use as critical components in life support systems, equipment used in hazardous environments, or nuclear control systems.

TECHNICAL REVISIONS - The appearance of products, including safety agency certifications pictured on labels, may change depending on the date manufactured. Specifications are subject to change without notice.