

Safety switch with separate actuator

AZ 16

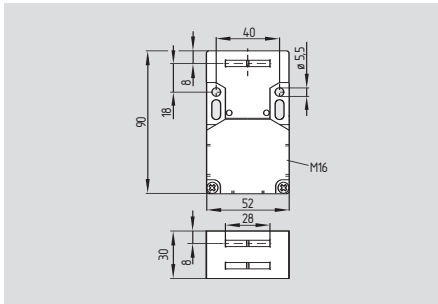

- Thermoplastic enclosure
- Multiple coding
- Individual coding available on request
- Long life
- Double insulated
- 3 cable entries M16 x 1.5
- Large wiring compartment
- High level of contact reliability with low voltages and currents
- Not sensitive to dirty conditions by virtue of patented roller system
- Available with LED
- Slotted holes for adjustment, circular holes for location
- AS-Interface Safety at Work available, see chapter 5

Technical data

Standards: IEC/EN 60947-5-1
BG-GS-ET-15

Enclosure: glass-fibre reinforced thermoplastic, self-extinguishing

Actuator: stainless steel 1.4301

Protection class: IP 67 to EN 60529

Contact material: silver

Contact type: change-over contact with double break, type Zb or 2 NC or 3 NC contacts, with galvanically separated contact bridges

Switching system: \ominus IEC 60947-5-1 slow action, NC contact with positive break

Connection: screw terminals

Cable section: max. 2.5 mm² (incl. conductor ferrules)

Cable entry: 3 x M16 x 1.5

U_{imp} : 6 kV

U_i : 500 V

I_{the} : 10 A

Utilisation category: AC-15, DC-13

I_e/U_e : 4 A / 230 VAC
4 A / 24 VDC

Max. fuse rating: 6 A gG D-fuse

Positive break travel: 8 mm

Positive break force: 10 N for each NC contact fitted

Ambient temperature: -30 °C ... +80 °C

Mechanical life: > 1 million operations

Latching force: 30 N for ordering suffix r

Contact variants

1 NO / 1 NC



2 NC



3 NC



1 NO / 2 NC



with individual coding



Connector

1 NO / 1 NC

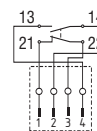

2 NC

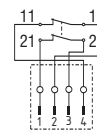

Approvals



Ordering details

AZ16-①zv②k-③-④-⑤

No.	Replace	Description
①		1 NO / 1 NC
	02	2 NC
	03	3 NC
	12	1 NO / 2 NC
②	r	Ejection force Latching force 30 N
	G24	With LED
④		Cable entry M 16
	M20	Cable entry M 20
	ST	Connector M12 x 1 bottom
	STL	Connector M12 x 1 left
	STR	Connector M12 x 1 right
⑤	2254	Latching force 5 N
	1762	Front mounting
	1637	Gold-plated contacts

Note

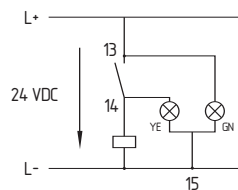

LED version:

Ordering suffix G24, only available for version with one NO and one NC contact. Protected against incorrect polarity and voltage spikes.

Note

Actuators must be ordered separately.

Safety switch with separate actuator

System components

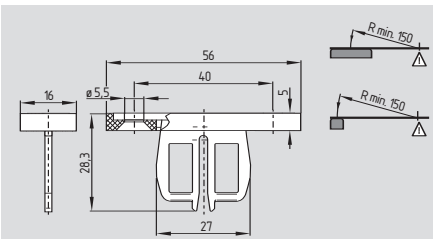

Straight actuator AZ 15/16-B1

System components

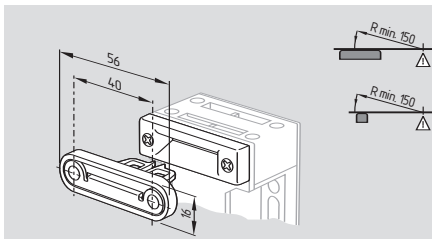

AZ 15/16-B1-2177 with centering guide

System components

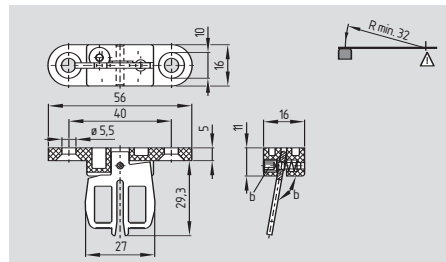

Flexible actuator AZ 15/16-B3

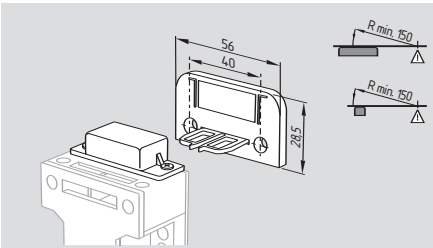

AZ 15/16-B1-1747 with magnetic latch

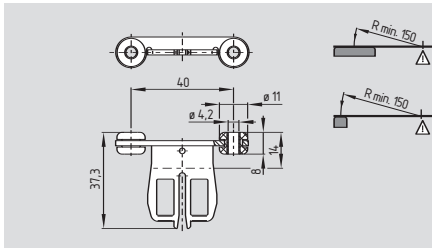

AZ 15/16-B1-2245 with rubber mounting

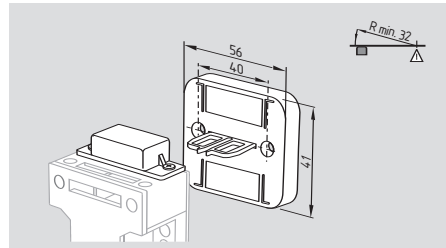

AZ 15/16-B3-1747 with magnetic latch

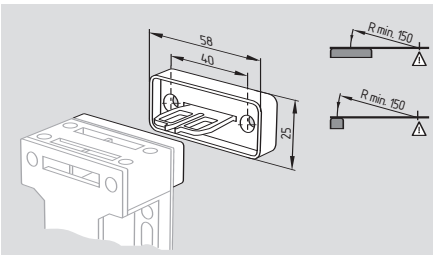

AZ 15/16-B1-2024 with slot lip-seal

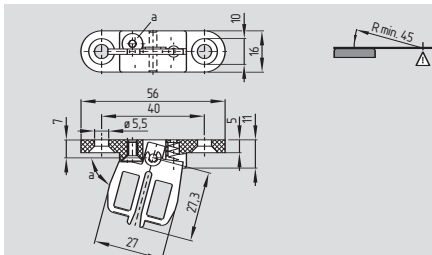

Flexible actuator AZ 15/16-B2

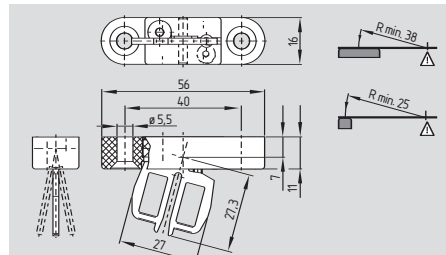

Flexible actuator AZ 15/16-B6

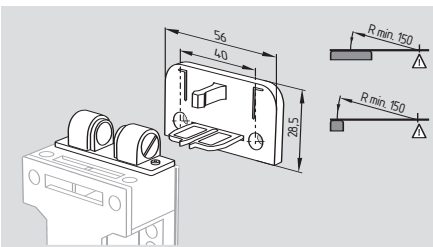

AZ 15/16-B1-2053 with ball latch

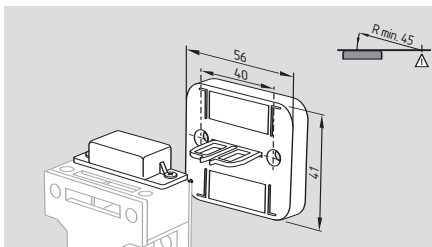

AZ 15/16-B2-1747 with magnetic latch

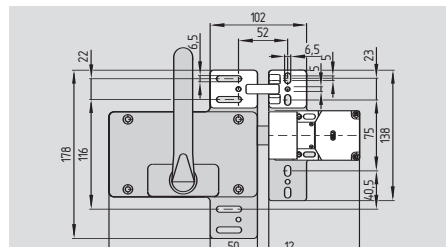

Actuator AZ 16-B30

Ordering details

Straight actuator
with magnetic latch
with slot lip-seal
with ball latch

AZ 15/16-B1
AZ 15/16-B1-1747
AZ 15/16-B1-2024
AZ 15/16-B1-2053

Straight actuator
with centering guide
with rubber mounting
Flexible actuator
with magnetic latch

AZ 15/16-B1-2177
AZ 15/16-B1-2245
AZ 15/16-B2
AZ 15/16-B2-1747

Ordering details

Flexible actuator
with magnetic latch
Flexible actuator

AZ 15/16-B3
AZ 15/16-B3-1747
AZ 15/16-B6

Actuator with or without
emergency handle

AZ 16-B30

A detailed product description can
be found in the „Safety door handle
system STS“ brochure.

Safety switch with separate actuator

System components

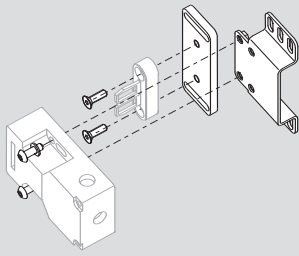

Mounting set MS AZ 15/16

System components

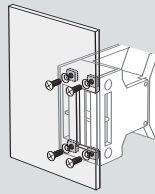

Front mounting AZ 15/16 -1762

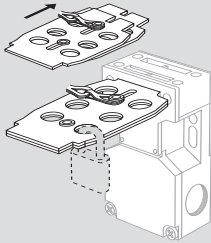

Lockout tag SZ 16/335



Connector plug M 12 x 1

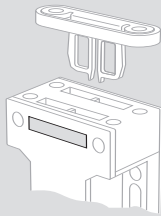

Slot sealing plug AZ 15/16-1476



Connector plug M 12 x 1 (with cable)

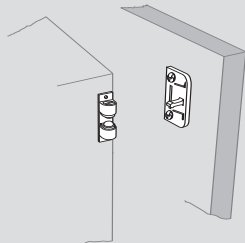

Ball catch 2053-2



Tamperproof screws

Ordering details

Mounting set **MS AZ 15/16**
 Lockout tag **SZ 16/335**
 Slot sealing plug **AZ 15/16-1476**
 Ball catch **-2053-2**

Ordering details

Front mounting with M5 nuts **-1762**
 Connector plug M 12 x 1 **1093038**
 Connector plug M 12 x 1 (with cable) **1148412**
 Tamperproof screws with unidirectional slots
 M5 x 12 **1135338**
 M5 x 16 **1135339**
 M5 x 20 **1135340**
 (Quantity 2 pcs)