

RED INDICATES ORIGINAL

DWG SIZE C DATA CONTAINED IN THIS DOCUMENT IS PROPRIETARY TO TROMPETER ELECTRONICS INC. AND SHALL NOT BE DISCLOSED, COPIED OR REPRODUCED IN ANY MANNER WITHOUT EXPRESS WRITTEN PERMISSION.

REV		DESCRIPTION	12-01		SH 1
REV	ECO	DESCRIPTION	DWN	APPROVED	DATE
J	11191	ADDED C.J70TL, -201 THRU -220; ADDED ITEM 34; SEE ECO	DKC		

P2 CONN TYPE	FIG NO	P1 CONN TYPE																			
		BJ20					LBJ20					BJ40					LBJ40				
		E1	E2	E3	E4	E5	E1	E2	E3	E4	E5	E1	E2	E3	E4	E5	E1	E2	E3	E4	E5
DASH NUMBERS																					
BJ74	1A	-1	-2	-3	-4	-169	-5	-6	-7	-9	-170	-9	-10	-11	-12	-171	-13	-14	-15	-16	-172
BJ74TL	1A	-17	-18	-19	-20	-173	-21	-22	-23	-24	-174	-25	-26	-27	-28	-175	-29	-30	-31	-32	-176
BJ74FL	1A	-33	-34	-35	-36	-177	-37	-38	-39	-40	-178	-41	-42	-43	-44	-179	-45	-46	-47	-48	-180
BJ374	1B	-49	-50	-51	-52	-181	-53	-54	-55	-56	-182	-57	-58	-59	-60	-183	-61	-62	-63	-64	-184
BJ79	2A	-65	-66	-67	-68	-185	-69	-70	-71	-72	-186	-73	-74	-75	-76	-187	-77	-78	-79	-80	-188
BJ79TL	2A	-81	-82	-83	-84	-189	-85	-86	-87	-88	-190	-89	-90	-91	-92	-191	-93	-94	-95	-96	-192
BJ79FL	2A	-97	-98	-99	-100	-193	-101	-102	-103	-104	-194	-105	-106	-107	-108	-195	-109	-110	-111	-112	-196
BJ379	2B	-113	-114	-115	-116	-197	-117	-118	-119	-120	-198	-121	-122	-123	-124	-199	-125	-126	-127	-128	-200
CJ70	3A	-129	-130	-131	-132	-133	-134	-135	-136	-137	-138	-139	-140	-141	-142	-143	-144	-145	-146	-147	-148
CJ370	3B	-149	-150	-151	-152	-153	-154	-155	-156	-157	-158	-159	-160	-161	-162	-163	-164	-165	-166	-167	-168
CJ70TL	3A	-201	-202	-203	-204	-205	-206	-207	-208	-209	-210	-211	-212	-213	-214	-215	-216	-217	-218	-219	-220

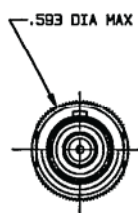
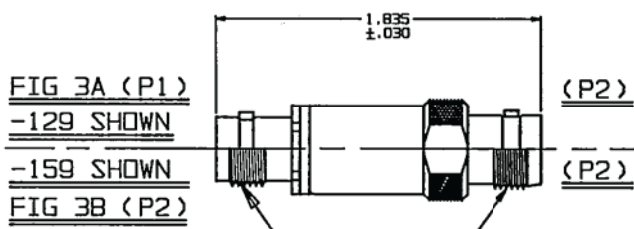
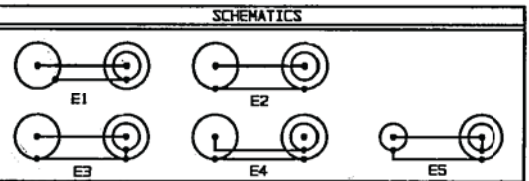

FIG 1A (P1)
-1 SHOWN
-57 SHOWN
FIG 1B (P1)

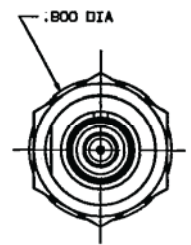
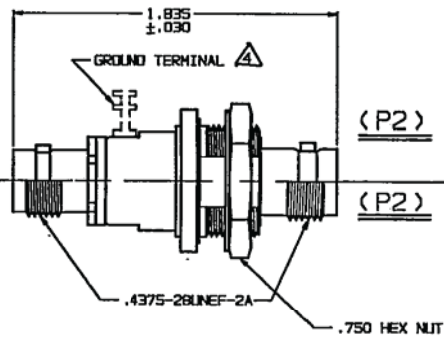
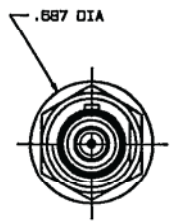
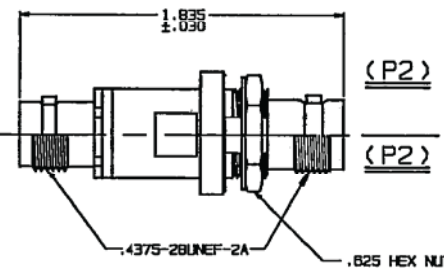

FIG 2A (P1)
-65 SHOWN
-121 SHOWN
FIG 2B (P1)



INCH	MM
.005	0.13
.030	0.76
.109	2.77
.140	3.56
.218	5.54
.221	5.61
.281	7.14
.284	7.21
.505	12.83
.510	12.95
.593	15.06
.625	15.88
.630	16.00
.635	16.13
.667	17.45
.750	19.05
.800	20.32
1.835	46.61

▲ FOR OPTIONAL GROUND TERMINAL ADD PREFIX "G" TO DASH NO (-G1 ETC)

- BETWEEN SERIES ADAPTER, 50 & 75 OHM BNC/TNC COAXIAL JACK TO CONCENTRIC TWINAX/TRIAX INSULATED & NONINSULATED BULKHEAD MOUNT JACK
- FINISH: TFS-1A (NICKEL)
- ALL DIM ARE IN INCHES

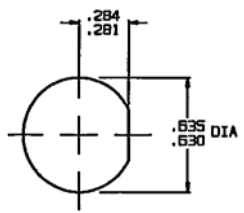

RECOMMENDED PANEL CUTOUT
FOR -1 THRU -64
MAX PNL THK .140

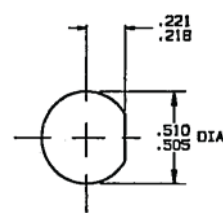

RECOMMENDED PANEL CUTOUT
FOR -65 THRU -128
MAX PNL THK .109

QTY	DESCRIPTION	PART NUMBER	ITEM
TOL UNLESS SPECIFIED +.005 ± -.005 ± ANGLES	TROMPETER RF connectivity	ADAPTERS: U/BJ20/40 TO *70* SERIES BULKHEAD MOUNT	
DWN	DKC	8-1-85	MATERIAL
CHK			CODE IDENT
ENGR			DRAWING NO.
APPR			14949
			DATE 8/17/85
			SHEET 1 OF 2