

EPIC® HD series

Compact high-density crimp-terminated inserts for control applications



EPIC® HD series inserts are designed for use in industries where large numbers of contacts are required and limited space is available. These high-density crimp inserts are available with stamped & formed or machined contacts and fit into EPIC® HA & HB series housings.

Technical data

| | | | |
|----------------------------|---|--|---|
| Number of contacts: | 7, 8, 15, 25, 40, 50, 64, 80, 128 (+PE) | Rated voltage: | |
| Temperature range: | -40°C to +100°C | - UL/CSA: | 250V |
| - short-term: | up to +125°C | - IEC EPIC® HD 7 - 8: | |
| Pollution level: | 3 | - in metal housing: | 24V AC/60V DC |
| Mating cycles: | - per DIN EN 61984:2008 | - in plastic housing: | 250V |
| | Service Life Test: Tested to 100 cycles and passed | - IEC EPIC® HD 15 - 128: | 250V |
| | - per Contact Thermal Test: Useful service up to 500 cycles is possible at rated voltage and current* | Test voltage: | 2.5 kV |
| Rated current: | | Wire size: | 26 - 14 AWG (0.14 - 2.5 mm ²) |
| - UL/CSA, IEC: | 10A | Contact material: | silver- or gold-plated copper alloy |
| | | Contact resistance: | < 2 mΩ |
| | | - EPIC® HD 40, 64 - 128 (machined contacts): | < 3 mΩ |

* In dry, non-conductive, non-corrosive environments when protected in a housing rated at least IP54 and disconnected for cycling and maintenance only.

EPIC® HD derating curves

20 AWG (0.5 mm²) machined contacts

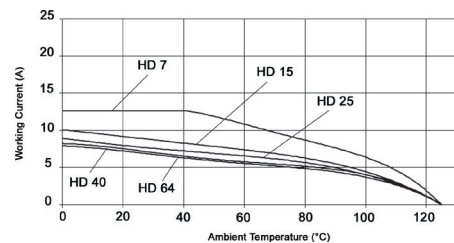

16 AWG (1.5 mm²) machined contacts

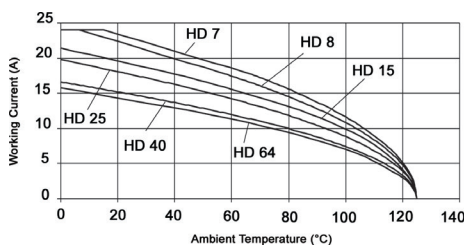

16 AWG (1.5 mm²) stamped & formed contacts

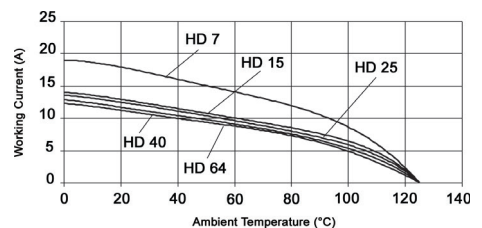

14 AWG (2.5 mm²) machined contacts

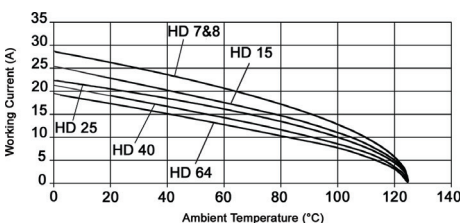

14 AWG (2.5 mm²) stamped & formed contacts

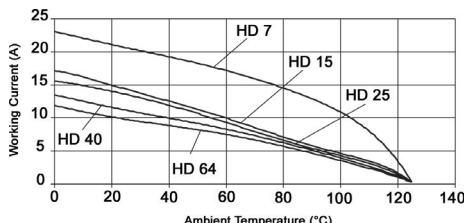

EPIC® HD 7

Crimp termination for machined contacts: 250V, 10A

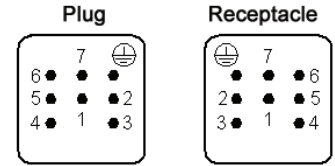
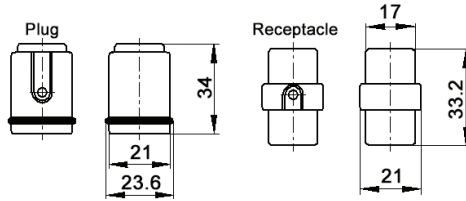

contacts sold separately, see below

all dimensions are in mm

view from cable side

| Termination | Contact type | Plug | Receptacle |
|-------------------|--------------|----------|------------|
| crimp termination | machined | 11250500 | 11251500 |

Compatible housing

HA 3/4
page 413

Approvals

1.6 mm contacts

Machined contacts for EPIC® HD series inserts

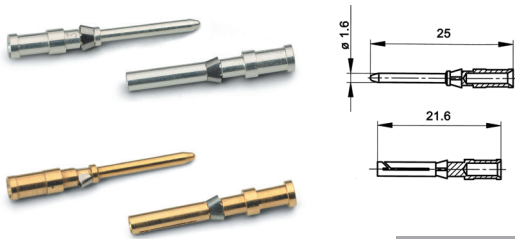

contacts sold in bags of 100

| Contact size | | Stripping length mm | # of marking tracks | Bag of 100 silver contacts | | Bag of 100 gold contacts | |
|-----------------|-------|------------------------|---------------------|----------------------------|----------|--------------------------|----------|
| mm ² | AWG | | | pin | socket | pin | socket |
| 0.14-0.37 | 26-22 | 8 | 1 | 13162000 | 13163000 | 13162500 | 13163500 |
| 0.5 | 20 | 8 | 2 | 13162100 | 13163100 | 13162600 | 13163600 |
| 0.75-1.0 | 18 | 8 | 3 | 13162200 | 13163200 | 13162700 | 13163700 |
| 1.5 | 16 | 8 | 4 | 13162300 | 13163300 | 13162800 | 13163800 |
| 2.5 | 14 | 8 | 5 | 13162400 | 13163400 | 13162900 | 13163900 |

Contact tools

| | | | |
|-------------------------|-------------------------|----------------------|---------------------------|
| Crimp tool: 11147000 | Crimp dies: 11147100 | Locator: 11147200 | Removal tool: 11161000 |
|-------------------------|-------------------------|----------------------|---------------------------|

If not otherwise specified, all values relating to the product are nominal values. Photographs are not to scale and are not true representations of the products in question.

EPIC® HD 7

Crimp-terminated for stamped & formed contacts: 250V, 10A



contacts sold separately, see below

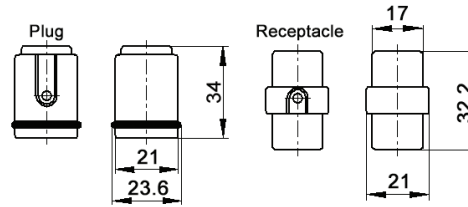

all dimensions are in mm

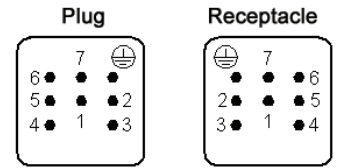

view from cable side

| Termination | Contact type | Plug | Receptacle |
|-------------------|------------------|----------|------------|
| crimp termination | stamped & formed | 11250000 | 11251000 |

Compatible housing

HA 3/4
page 413

Approvals



1.6 mm contacts

Stamped & formed contacts for EPIC® HD series inserts

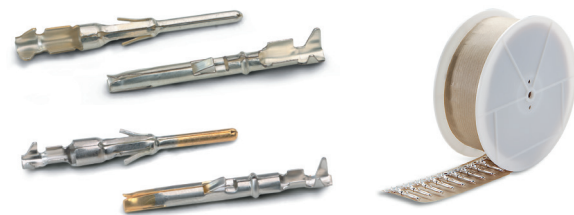

contacts sold in bags of 100 or 1 reel

Contact tools

| | | | | | |
|--|---|--|--|--|---------------------------|
| | Crimp tool: 11147000 | | Locator: 11147300 | | Removal tool: 11161000 |
| | Crimp dies: 0.14-0.5 mm²: 11147170 0.5-1.5 mm²: 11147180 1.5-2.5 mm²: 11147190 | | Crimp tool, die & locator: 0.14-0.5 mm²: 11147004 0.5-1.5 mm²: 11147005 1.5-2.5 mm²: 11147006 | | |

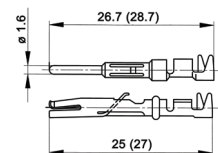

| Contact size mm² | AWG | Stripping length mm | Bag of 100 silver contacts | | Bag of 100 gold contacts | | Reel of 100 silver contacts: left-hand feed | | Reel of 200 silver contacts: left-hand feed | |
|---------------------|-------|------------------------|----------------------------|----------|--------------------------|----------|--|----------|--|----------|
| | | | pin | socket | pin | socket | pin | socket | pin | socket |
| 0.14-0.5 | 26-20 | 2.5-0.5 | 11241100 | 11231100 | 11243100 | 11233100 | — | — | 11240700 | 11230700 |
| 0.5-1.5 | 20-16 | 3.5-0.5 | 11221000 | 11236100 | 11221300 | 11238100 | — | — | 11220700 | 11235700 |
| 1.5-2.5 | 16-14 | 3.5-0.5 | 11223500 | 11228500 | — | — | 11223000 | 11228000 | — | — |

| Contact size mm² | AWG | Stripping length mm | Reel of 2000 silver contacts: right-hand feed | | Reel of 2000 gold contacts: right-hand feed | | Reel of 2000 silver contacts: left-hand feed | | Reel of 2000 gold contacts: left-hand feed | |
|---------------------|-------|------------------------|--|----------|--|----------|---|----------|---|----------|
| | | | pin | socket | pin | socket | pin | socket | pin | socket |
| 0.14-0.5 | 26-20 | 2.5-0.5 | 11240000 | 11230000 | — | — | 11240400 | 11230400 | 11240500 | 11230500 |
| 0.5-1.5 | 20-16 | 3.5-0.5 | 11220000 | 11235000 | 11220100 | 11235200 | 11226000 | 11226500 | — | — |
| 1.5-2.5 | 16-14 | 3.5-0.5 | — | — | — | — | 11222700 | 11227700 | — | — |

If not otherwise specified, all values relating to the product are nominal values. Photographs are not to scale and are not true representations of the products in question.

EPIC® HD 8

Crimp termination for machined contacts: 250V, 10A

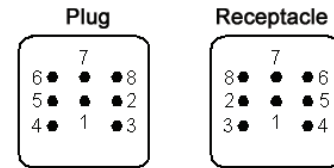
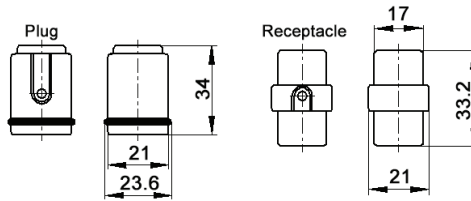

contacts sold separately, see below

all dimensions are in mm

view from cable side

| Termination | Contact type | Plug | Receptacle |
|-------------------|--------------|----------|------------|
| crimp termination | machined | 11252500 | 11253500 |

Compatible housing

HA 3/4
page 413

Approvals



1.6 mm contacts

Machined contacts for EPIC® HD series inserts

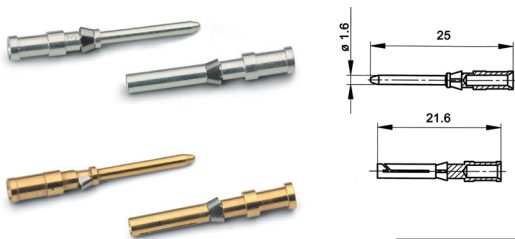

contacts sold in bags of 100

| Contact size | | Stripping length mm | # of marking tracks | Bag of 100 silver contacts | | Bag of 100 gold contacts | |
|-----------------|-------|------------------------|---------------------|----------------------------|----------|--------------------------|----------|
| mm ² | AWG | | | pin | socket | pin | socket |
| 0.14-0.37 | 26-22 | 8 | 1 | 13162000 | 13163000 | 13162500 | 13163500 |
| 0.5 | 20 | 8 | 2 | 13162100 | 13163100 | 13162600 | 13163600 |
| 0.75-1.0 | 18 | 8 | 3 | 13162200 | 13163200 | 13162700 | 13163700 |
| 1.5 | 16 | 8 | 4 | 13162300 | 13163300 | 13162800 | 13163800 |
| 2.5 | 14 | 8 | 5 | 13162400 | 13163400 | 13162900 | 13163900 |

Contact tools

| | | | |
|-------------------------|-------------------------|----------------------|---------------------------|
| Crimp tool: 11147000 | Crimp dies: 11147100 | Locator: 11147200 | Removal tool: 11161000 |
|-------------------------|-------------------------|----------------------|---------------------------|

If not otherwise specified, all values relating to the product are nominal values. Photographs are not to scale and are not true representations of the products in question.

EPIC® HD 15

Crimp termination for machined contacts: 250V, 10A



contacts sold separately, see below

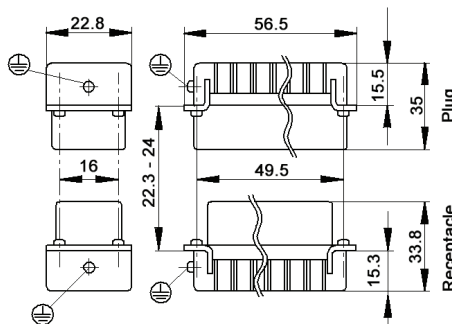

all dimensions are in mm

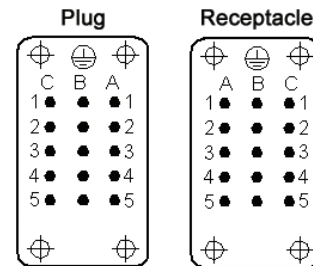

view from cable side

| Termination | Contact type | Plug | Receptacle |
|-------------------|--------------|----------|------------|
| crimp termination | machined | 11283200 | 11282200 |

Compatible housing



HA 10
page 415

Approvals



1.6 mm contacts

Machined contacts for EPIC® HD series inserts

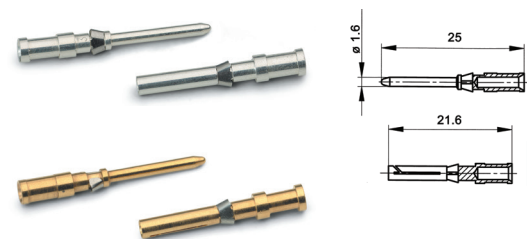

contacts sold in bags of 100

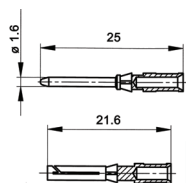

| Contact size | | Stripping length mm | # of marking tracks | Bag of 100 silver contacts | | Bag of 100 gold contacts | |
|--------------|---------|---------------------|---------------------|----------------------------|----------|--------------------------|----------|
| mm² | AWG | | | pin | socket | pin | socket |
| 0.14 - 0.37 | 26 - 22 | 8 | 1 | 13162000 | 13163000 | 13162500 | 13163500 |
| 0.5 | 20 | 8 | 2 | 13162100 | 13163100 | 13162600 | 13163600 |
| 0.75 - 1.0 | 18 | 8 | 3 | 13162200 | 13163200 | 13162700 | 13163700 |
| 1.5 | 16 | 8 | 4 | 13162300 | 13163300 | 13162800 | 13163800 |
| 2.5 | 14 | 8 | 5 | 13162400 | 13163400 | 13162900 | 13163900 |

Contact tools



Crimp tool:
11147000



Crimp dies:
11147100



Locator:
11147200



Removal tool:
11161000

If not otherwise specified, all values relating to the product are nominal values. Photographs are not to scale and are not true representations of the products in question.

EPIC® HD 15

Crimp-terminated for stamped & formed contacts: 250V, 10A



contacts sold separately, see below

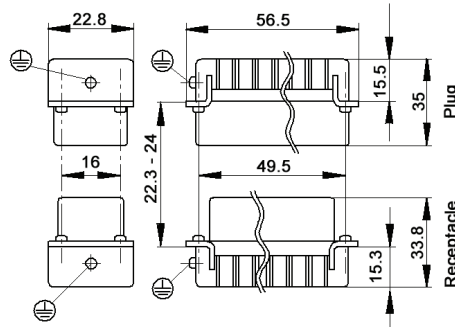

all dimensions are in mm

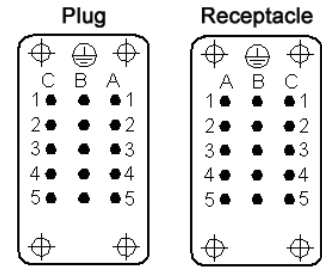

view from cable side

| Termination | Contact type | Plug | Receptacle |
|-------------------|------------------|----------|------------|
| crimp termination | stamped & formed | 11255000 | 11256000 |

Compatible housing

HA 10
page 415

Approvals

1.6 mm contacts

Stamped & formed contacts for EPIC® HD series inserts

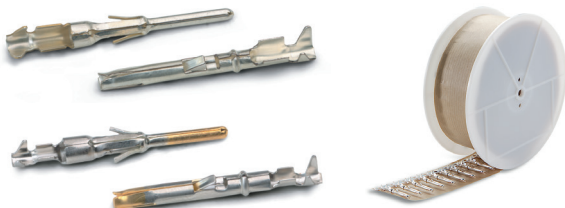

contacts sold in bags of 100 or 1 reel

Contact tools

| | | |
|--|---|---------------------------|
| Crimp tool: 11147000 | Locator: 11147300 | Removal tool: 11161000 |
| Crimp dies: 0.14 - 0.5 mm ² : 11147170 0.5 - 1.5 mm ² : 11147180 1.5 - 2.5 mm ² : 11147190 | Crimp tool, die & locator: 0.14 - 0.5 mm ² : 11147004 0.5 - 1.5 mm ² : 11147005 1.5 - 2.5 mm ² : 11147006 | |

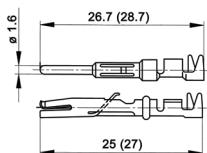

| Contact size | | Stripping length mm | Bag of 100 silver contacts | | Bag of 100 gold contacts | | Reel of 100 silver contacts: left-hand feed | | Reel of 200 silver contacts: left-hand feed | |
|-----------------|---------|------------------------|----------------------------|----------|--------------------------|----------|--|----------|--|----------|
| mm ² | AWG | | pin | socket | pin | socket | pin | socket | pin | socket |
| 0.14 - 0.5 | 26 - 20 | 2.5 - 0.5 | 11241100 | 11231100 | 11243100 | 11233100 | — | — | 11240700 | 11230700 |
| 0.5 - 1.5 | 20 - 16 | 3.5 - 0.5 | 11221000 | 11236100 | 11221300 | 11238100 | — | — | 11220700 | 11235700 |
| 1.5 - 2.5 | 16 - 14 | 3.5 - 0.5 | 11223500 | 11228500 | — | — | 11223000 | 11228000 | — | — |

| Contact size | | Stripping length mm | Reel of 2000 silver contacts: right-hand feed | | Reel of 2000 gold contacts: right-hand feed | | Reel of 2000 silver contacts: left-hand feed | | Reel of 2000 gold contacts: left-hand feed | |
|-----------------|---------|------------------------|--|----------|--|----------|---|----------|---|----------|
| mm ² | AWG | | pin | socket | pin | socket | pin | socket | pin | socket |
| 0.14 - 0.5 | 26 - 20 | 2.5 - 0.5 | 11240000 | 11230000 | — | — | 11240400 | 11230400 | 11240500 | 11230500 |
| 0.5 - 1.5 | 20 - 16 | 3.5 - 0.5 | 11220000 | 11235000 | 11220100 | 11235200 | 11226000 | 11226500 | — | — |
| 1.5 - 2.5 | 16 - 14 | 3.5 - 0.5 | — | — | — | — | 11222700 | 11227700 | — | — |

If not otherwise specified, all values relating to the product are nominal values. Photographs are not to scale and are not true representations of the products in question.

EPIC® HD 25

Crimp termination for machined contacts: 250V, 10A

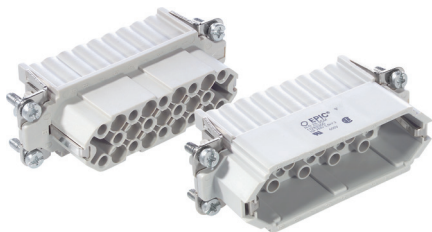

contacts sold separately, see below

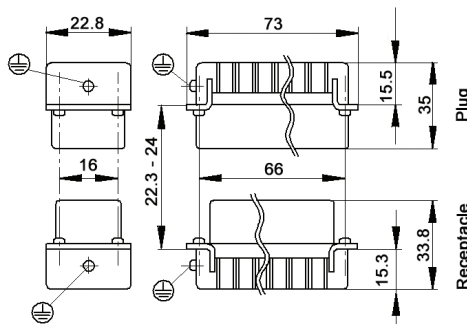

all dimensions are in mm

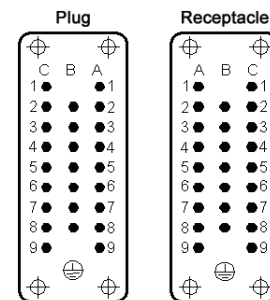

view from cable side

| Termination | Contact type | Plug | Receptacle |
|-------------------|--------------|----------|------------|
| crimp termination | machined | 11283300 | 11282300 |

Compatible housing



HA 16
page 417

Approvals



1.6 mm contacts

Machined contacts for EPIC® HD series inserts

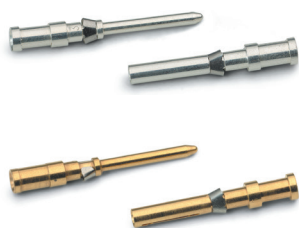

contacts sold in bags of 100

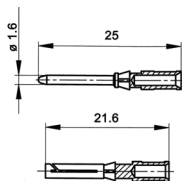

| Contact size | | Stripping length mm | # of marking tracks | Bag of 100 silver contacts | | Bag of 100 gold contacts | |
|--------------|---------|---------------------|---------------------|----------------------------|----------|--------------------------|----------|
| mm² | AWG | | | pin | socket | pin | socket |
| 0.14 - 0.37 | 26 - 22 | 8 | 1 | 13162000 | 13163000 | 13162500 | 13163500 |
| 0.5 | 20 | 8 | 2 | 13162100 | 13163100 | 13162600 | 13163600 |
| 0.75 - 1.0 | 18 | 8 | 3 | 13162200 | 13163200 | 13162700 | 13163700 |
| 1.5 | 16 | 8 | 4 | 13162300 | 13163300 | 13162800 | 13163800 |
| 2.5 | 14 | 8 | 5 | 13162400 | 13163400 | 13162900 | 13163900 |

Contact tools



Crimp tool:
11147000



Crimp dies:
11147100



Locator:
11147200



Removal tool:
11161000

If not otherwise specified, all values relating to the product are nominal values. Photographs are not to scale and are not true representations of the products in question.

EPIC® HD 25

Crimp-terminated for stamped & formed contacts: 250V, 10A



contacts sold separately, see below

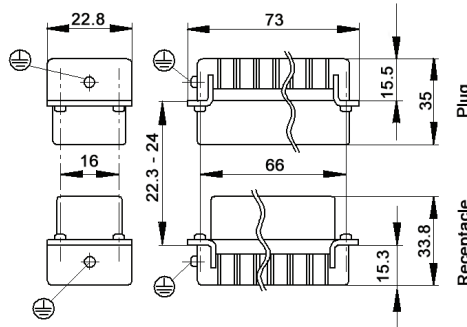

all dimensions are in mm

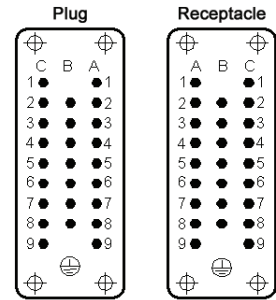

view from cable side

| Termination | Contact type | Plug | Receptacle |
|-------------------|------------------|----------|------------|
| crimp termination | stamped & formed | 11260000 | 11261000 |

Compatible housing

HA 16
page 417

Approvals

1.6 mm contacts

Stamped & formed contacts for EPIC® HD series inserts

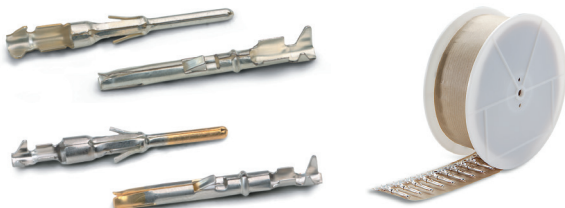

contacts sold in bags of 100 or 1 reel

Contact tools

| | | | | | |
|--|--|--|---|--|---------------------------|
| | Crimp tool: 11147000 | | Locator: 11147300 | | Removal tool: 11161000 |
| | Crimp dies: 0.14-0.5 mm ² : 11147170 0.5-1.5 mm ² : 11147180 1.5-2.5 mm ² : 11147190 | | Crimp tool, die & locator: 0.14-0.5 mm ² : 11147004 0.5-1.5 mm ² : 11147005 1.5-2.5 mm ² : 11147006 | | |

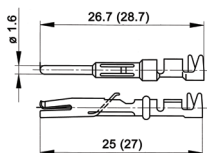

| Contact size mm ² AWG | Stripping length mm | Bag of 100 silver contacts | | Bag of 100 gold contacts | | Reel of 100 silver contacts: left-hand feed | | Reel of 200 silver contacts: left-hand feed | | |
|-------------------------------------|------------------------|----------------------------|----------|--------------------------|----------|--|----------|--|----------|----------|
| | | pin | socket | pin | socket | pin | socket | pin | socket | |
| 0.14-0.5 | 26-20 | 2.5-0.5 | 11241100 | 11231100 | 11243100 | 11233100 | — | — | 11240700 | 11230700 |
| 0.5-1.5 | 20-16 | 3.5-0.5 | 11221000 | 11236100 | 11221300 | 11238100 | — | — | 11220700 | 11235700 |
| 1.5-2.5 | 16-14 | 3.5-0.5 | 11223500 | 11228500 | — | — | 11223000 | 11228000 | — | — |

| Contact size mm ² AWG | Stripping length mm | Reel of 2000 silver contacts: right-hand feed | | Reel of 2000 gold contacts: right-hand feed | | Reel of 2000 silver contacts: left-hand feed | | Reel of 2000 gold contacts: left-hand feed | | |
|-------------------------------------|------------------------|--|----------|--|----------|---|----------|---|----------|----------|
| | | pin | socket | pin | socket | pin | socket | pin | socket | |
| 0.14-0.5 | 26-20 | 2.5-0.5 | 11240000 | 11230000 | — | — | 11240400 | 11230400 | 11240500 | 11230500 |
| 0.5-1.5 | 20-16 | 3.5-0.5 | 11220000 | 11235000 | 11220100 | 11235200 | 11226000 | 11226500 | — | — |
| 1.5-2.5 | 16-14 | 3.5-0.5 | — | — | — | — | 11222700 | 11227700 | — | — |

If not otherwise specified, all values relating to the product are nominal values. Photographs are not to scale and are not true representations of the products in question.

EPIC® HD 40

Crimp termination for machined contacts: 250V, 10A

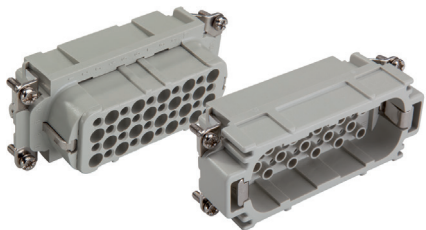

contacts sold separately, see below

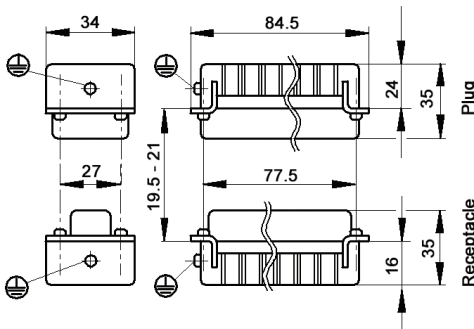

all dimensions are in mm

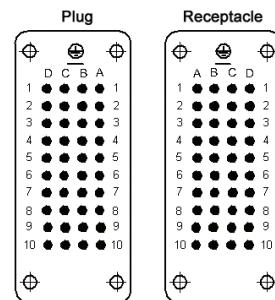

view from cable side

| Termination | Contact type | Plug | Receptacle |
|-------------------|--------------|----------|------------|
| crimp termination | machined | 11265200 | 11266200 |

Compatible housing



HB 16
page 388

Approvals



1.6 mm contacts

Machined contacts for EPIC® HD series inserts

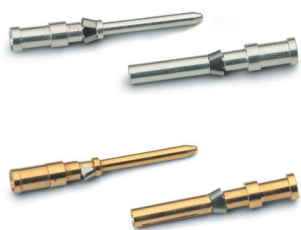

contacts sold in bags of 100

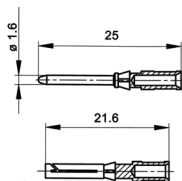

| Contact size | | Stripping length mm | # of marking tracks | Bag of 100 silver contacts | | Bag of 100 gold contacts | |
|--------------|---------|---------------------|---------------------|----------------------------|----------|--------------------------|----------|
| mm² | AWG | | | pin | socket | pin | socket |
| 0.14 - 0.37 | 26 - 22 | 8 | 1 | 13162000 | 13163000 | 13162500 | 13163500 |
| 0.5 | 20 | 8 | 2 | 13162100 | 13163100 | 13162600 | 13163600 |
| 0.75 - 1.0 | 18 | 8 | 3 | 13162200 | 13163200 | 13162700 | 13163700 |
| 1.5 | 16 | 8 | 4 | 13162300 | 13163300 | 13162800 | 13163800 |
| 2.5 | 14 | 8 | 5 | 13162400 | 13163400 | 13162900 | 13163900 |

Contact tools



Crimp tool:
11147000



Crimp dies:
11147100



Locator:
11147200



Removal tool:
11161000

If not otherwise specified, all values relating to the product are nominal values. Photographs are not to scale and are not true representations of the products in question.

EPIC® HD 40

Crimp-terminated for stamped & formed contacts: 250V, 10A

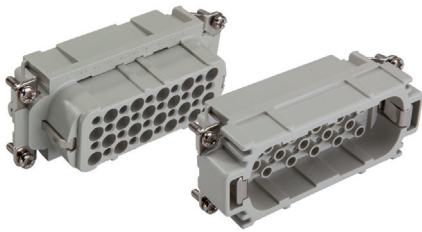

contacts sold separately, see below

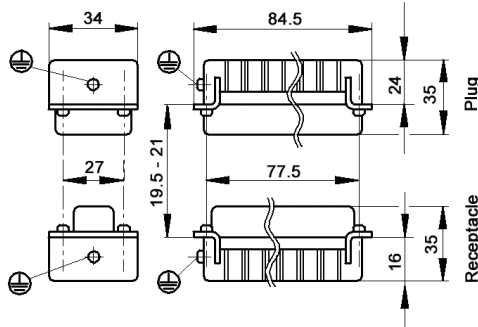

all dimensions are in mm

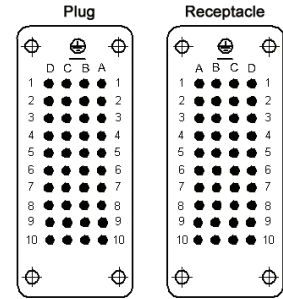

view from cable side

| Termination | Contact type | Plug | Receptacle |
|-------------------|------------------|----------|------------|
| crimp termination | stamped & formed | 11265000 | 11266000 |

Compatible housing



HB 16
page 388

Approvals



1.6 mm contacts

Stamped & formed contacts for EPIC® HD series inserts

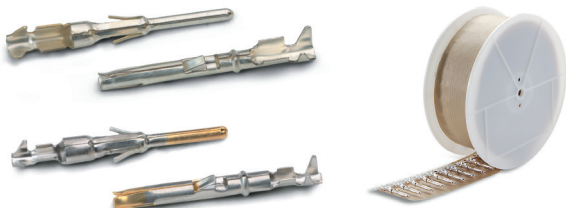

contacts sold in bags of 100 or 1 reel

Contact tools



Crimp tool:
11147000



Locator:
11147300



Removal tool:
11161000



Crimp dies:
0.14 - 0.5 mm²: 11147170
0.5 - 1.5 mm²: 11147180
1.5 - 2.5 mm²: 11147190



Crimp tool, die & locator:
0.14 - 0.5 mm²: 11147004
0.5 - 1.5 mm²: 11147005
1.5 - 2.5 mm²: 11147006

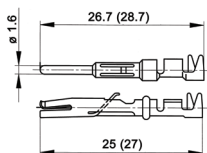

| Contact size mm ² AWG | Stripping length mm | Bag of 100 silver contacts | | Bag of 100 gold contacts | | Reel of 100 silver contacts: left-hand feed | | Reel of 200 silver contacts: left-hand feed | | |
|-------------------------------------|------------------------|----------------------------|----------|--------------------------|----------|--|----------|--|----------|----------|
| | | pin | socket | pin | socket | pin | socket | pin | socket | |
| 0.14 - 0.5 | 26 - 20 | 2.5 - 0.5 | 11241100 | 11231100 | 11243100 | 11233100 | — | — | 11240700 | 11230700 |
| 0.5 - 1.5 | 20 - 16 | 3.5 - 0.5 | 11221000 | 11236100 | 11221300 | 11238100 | — | — | 11220700 | 11235700 |
| 1.5 - 2.5 | 16 - 14 | 3.5 - 0.5 | 11223500 | 11228500 | — | — | 11223000 | 11228000 | — | — |

| Contact size mm ² AWG | Stripping length mm | Reel of 2000 silver contacts: right-hand feed | | Reel of 2000 gold contacts: right-hand feed | | Reel of 2000 silver contacts: left-hand feed | | Reel of 2000 gold contacts: left-hand feed | | |
|-------------------------------------|------------------------|--|----------|--|----------|---|----------|---|----------|----------|
| | | pin | socket | pin | socket | pin | socket | pin | socket | |
| 0.14 - 0.5 | 26 - 20 | 2.5 - 0.5 | 11240000 | 11230000 | — | — | 11240400 | 11230400 | 11240500 | 11230500 |
| 0.5 - 1.5 | 20 - 16 | 3.5 - 0.5 | 11220000 | 11235000 | 11220100 | 11235200 | 11226000 | 11226500 | — | — |
| 1.5 - 2.5 | 16 - 14 | 3.5 - 0.5 | — | — | — | — | 11222700 | 11227700 | — | — |

If not otherwise specified, all values relating to the product are nominal values. Photographs are not to scale and are not true representations of the products in question.

EPIC® HD 50

Crimp termination for machined contacts: 250V, 10A



contacts sold separately, see below

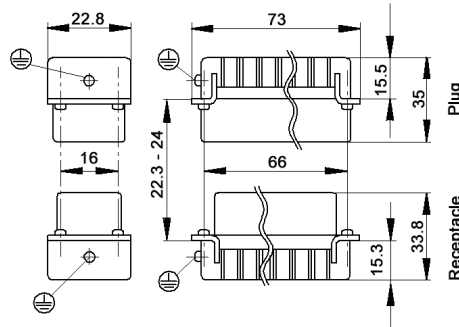

all dimensions are in mm

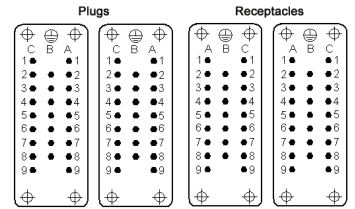

view from cable side

| Termination | Contact type | Plug | Receptacle |
|-------------------|--------------|-------------|-------------|
| crimp termination | machined | 11283300 x2 | 11282300 x2 |

x2 HD 25 inserts, use two part numbers

Compatible housing

HA 32
page 419

Approvals



1.6 mm contacts

Machined contacts for EPIC® HD series inserts

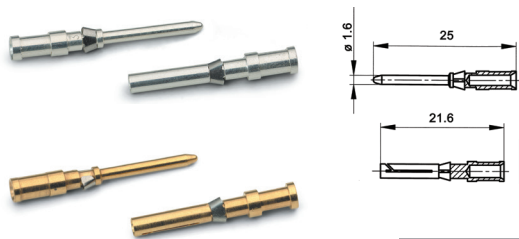

contacts sold in bags of 100

| Contact size mm² | AWG | Stripping length mm | # of marking tracks | Bag of 100 silver contacts | | Bag of 100 gold contacts | |
|---------------------|---------|------------------------|---------------------|----------------------------|----------|--------------------------|----------|
| | | | | pin | socket | pin | socket |
| 0.14 - 0.37 | 26 - 22 | 8 | 1 | 13162000 | 13163000 | 13162500 | 13163500 |
| 0.5 | 20 | 8 | 2 | 13162100 | 13163100 | 13162600 | 13163600 |
| 0.75 - 1.0 | 18 | 8 | 3 | 13162200 | 13163200 | 13162700 | 13163700 |
| 1.5 | 16 | 8 | 4 | 13162300 | 13163300 | 13162800 | 13163800 |
| 2.5 | 14 | 8 | 5 | 13162400 | 13163400 | 13162900 | 13163900 |

Contact tools

| | | | | | | | |
|--|-------------------------|--|-------------------------|--|----------------------|--|---------------------------|
| | Crimp tool: 11147000 | | Crimp dies: 11147100 | | Locator: 11147200 | | Removal tool: 11161000 |
|--|-------------------------|--|-------------------------|--|----------------------|--|---------------------------|

If not otherwise specified, all values relating to the product are nominal values. Photographs are not to scale and are not true representations of the products in question.

EPIC® HD 50

Crimp-terminated for stamped & formed contacts: 250V, 10A



contacts sold separately, see below

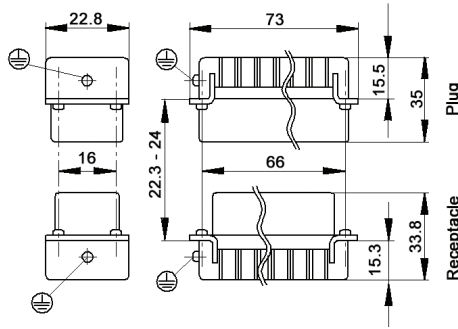

all dimensions are in mm

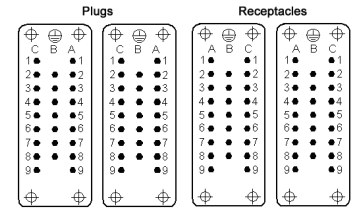

view from cable side

| Termination | Contact type | Plug | Receptacle |
|-------------------|------------------|-------------|-------------|
| crimp termination | stamped & formed | 11260000 x2 | 11261000 x2 |

x2 HD 25 inserts, use two part numbers

Compatible housing



HA 32
page 419

Approvals







1.6 mm contacts

Stamped & formed contacts for EPIC® HD series inserts



contacts sold in bags of 100 or 1 reel

Contact tools

| | | |
|--|---|---|
|  Crimp tool: 11147000 |  Locator: 11147300 |  Removal tool: 11161000 |
|  Crimp dies: 0.14 - 0.5 mm ² : 11147170 0.5 - 1.5 mm ² : 11147180 1.5 - 2.5 mm ² : 11147190 |  Crimp tool, die & locator: 0.14 - 0.5 mm ² : 11147004 0.5 - 1.5 mm ² : 11147005 1.5 - 2.5 mm ² : 11147006 | |

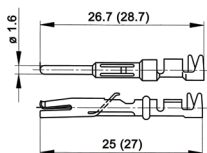

| Contact size mm ² AWG | Stripping length mm | Bag of 100 silver contacts | | Bag of 100 gold contacts | | Reel of 100 silver contacts: left-hand feed | | Reel of 200 silver contacts: left-hand feed | | |
|-------------------------------------|------------------------|----------------------------|----------|--------------------------|----------|--|----------|--|----------|----------|
| | | pin | socket | pin | socket | pin | socket | pin | socket | |
| 0.14 - 0.5 | 26 - 20 | 2.5 - 0.5 | 11241100 | 11231100 | 11243100 | 11233100 | — | — | 11240700 | 11230700 |
| 0.5 - 1.5 | 20 - 16 | 3.5 - 0.5 | 11221000 | 11236100 | 11221300 | 11238100 | — | — | 11220700 | 11235700 |
| 1.5 - 2.5 | 16 - 14 | 3.5 - 0.5 | 11223500 | 11228500 | — | — | 11223000 | 11228000 | — | — |

| Contact size mm ² AWG | Stripping length mm | Reel of 2000 silver contacts: right-hand feed | | Reel of 2000 gold contacts: right-hand feed | | Reel of 2000 silver contacts: left-hand feed | | Reel of 2000 gold contacts: left-hand feed | | |
|-------------------------------------|------------------------|--|----------|--|----------|---|----------|---|----------|----------|
| | | pin | socket | pin | socket | pin | socket | pin | socket | |
| 0.14 - 0.5 | 26 - 20 | 2.5 - 0.5 | 11240000 | 11230000 | — | — | 11240400 | 11230400 | 11240500 | 11230500 |
| 0.5 - 1.5 | 20 - 16 | 3.5 - 0.5 | 11220000 | 11235000 | 11220100 | 11235200 | 11226000 | 11226500 | — | — |
| 1.5 - 2.5 | 16 - 14 | 3.5 - 0.5 | — | — | — | — | 11222700 | 11227700 | — | — |

If not otherwise specified, all values relating to the product are nominal values. Photographs are not to scale and are not true representations of the products in question.

EPIC® HD 64

Crimp termination for machined contacts: 250V, 10A

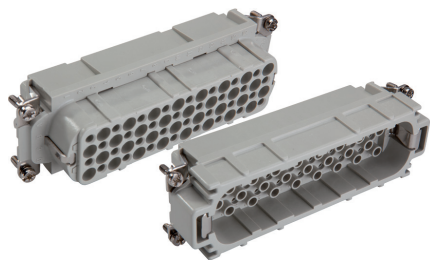

contacts sold separately, see below

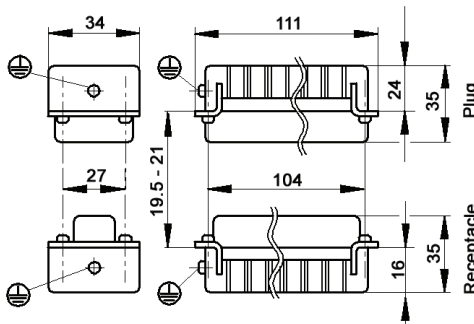

all dimensions are in mm

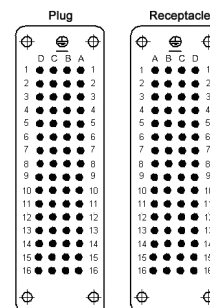

view from cable side

| Termination | Contact type | Plug | Receptacle |
|-------------------|--------------|----------|------------|
| crimp termination | machined | 11272000 | 11273000 |

Compatible housing



HB 24
page 394

Approvals



1.6 mm contacts

Machined contacts for EPIC® HD series inserts

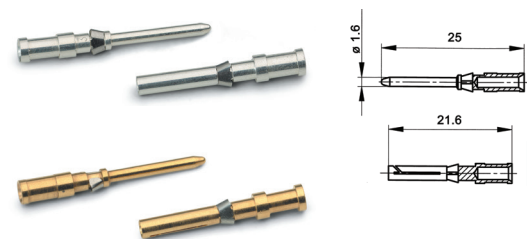

contacts sold in bags of 100

| Contact size | | Stripping length mm | # of marking tracks | Bag of 100 silver contacts | | Bag of 100 gold contacts | |
|--------------|---------|---------------------|---------------------|----------------------------|----------|--------------------------|----------|
| mm² | AWG | | | pin | socket | pin | socket |
| 0.14 - 0.37 | 26 - 22 | 8 | 1 | 13162000 | 13163000 | 13162500 | 13163500 |
| 0.5 | 20 | 8 | 2 | 13162100 | 13163100 | 13162600 | 13163600 |
| 0.75 - 1.0 | 18 | 8 | 3 | 13162200 | 13163200 | 13162700 | 13163700 |
| 1.5 | 16 | 8 | 4 | 13162300 | 13163300 | 13162800 | 13163800 |
| 2.5 | 14 | 8 | 5 | 13162400 | 13163400 | 13162900 | 13163900 |

Contact tools



Crimp tool:
11147000



Crimp dies:
11147100



Locator:
11147200



Removal tool:
11161000

If not otherwise specified, all values relating to the product are nominal values. Photographs are not to scale and are not true representations of the products in question.

EPIC® HD 64

Crimp-terminated for stamped & formed contacts: 250V, 10A

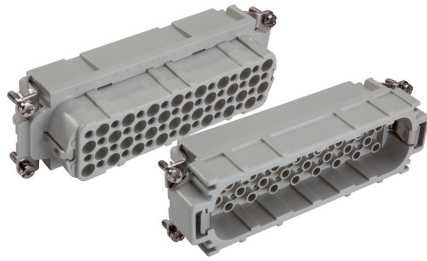

contacts sold separately, see below

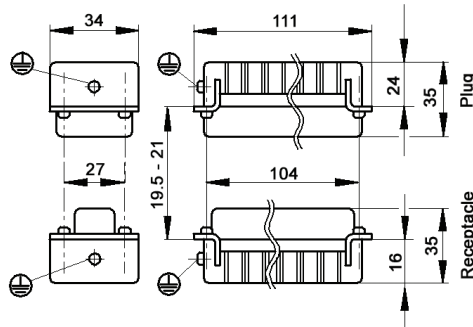

all dimensions are in mm

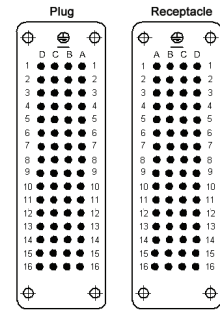

view from cable side

| Termination | Contact type | Plug | Receptacle |
|-------------------|------------------|----------|------------|
| crimp termination | stamped & formed | 11270000 | 11271000 |

Compatible housing

HB 24
page 394

Approvals

1.6 mm contacts

Stamped & formed contacts for EPIC® HD series inserts



contacts sold in bags of 100 or 1 reel

Contact tools

| | | | | | |
|--|--|--|---|--|---------------------------|
| | Crimp tool: 11147000 | | Locator: 11147300 | | Removal tool: 11161000 |
| | Crimp dies: 0.14 - 0.5 mm ² : 11147170 0.5 - 1.5 mm ² : 11147180 1.5 - 2.5 mm ² : 11147190 | | Crimp tool, die & locator: 0.14 - 0.5 mm ² : 11147004 0.5 - 1.5 mm ² : 11147005 1.5 - 2.5 mm ² : 11147006 | | |

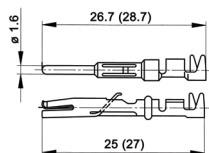

| Contact size mm ² AWG | Stripping length mm | Bag of 100 silver contacts | | Bag of 100 gold contacts | | Reel of 100 silver contacts: left-hand feed | | Reel of 200 silver contacts: left-hand feed | | |
|-------------------------------------|------------------------|----------------------------|----------|--------------------------|----------|--|----------|--|----------|----------|
| | | pin | socket | pin | socket | pin | socket | pin | socket | |
| 0.14 - 0.5 | 26 - 20 | 2.5 - 0.5 | 11241100 | 11231100 | 11243100 | 11233100 | — | — | 11240700 | 11230700 |
| 0.5 - 1.5 | 20 - 16 | 3.5 - 0.5 | 11221000 | 11236100 | 11221300 | 11238100 | — | — | 11220700 | 11235700 |
| 1.5 - 2.5 | 16 - 14 | 3.5 - 0.5 | 11223500 | 11228500 | — | — | 11223000 | 11228000 | — | — |

| Contact size mm ² AWG | Stripping length mm | Reel of 2000 silver contacts: right-hand feed | | Reel of 2000 gold contacts: right-hand feed | | Reel of 2000 silver contacts: left-hand feed | | Reel of 2000 gold contacts: left-hand feed | | |
|-------------------------------------|------------------------|--|----------|--|----------|---|----------|---|----------|----------|
| | | pin | socket | pin | socket | pin | socket | pin | socket | |
| 0.14 - 0.5 | 26 - 20 | 2.5 - 0.5 | 11240000 | 11230000 | — | — | 11240400 | 11230400 | 11240500 | 11230500 |
| 0.5 - 1.5 | 20 - 16 | 3.5 - 0.5 | 11220000 | 11235000 | 11220100 | 11235200 | 11226000 | 11226500 | — | — |
| 1.5 - 2.5 | 16 - 14 | 3.5 - 0.5 | — | — | — | — | 11222700 | 11227700 | — | — |

If not otherwise specified, all values relating to the product are nominal values. Photographs are not to scale and are not true representations of the products in question.

EPIC® HD 80

Crimp termination for machined contacts: 250V, 10A

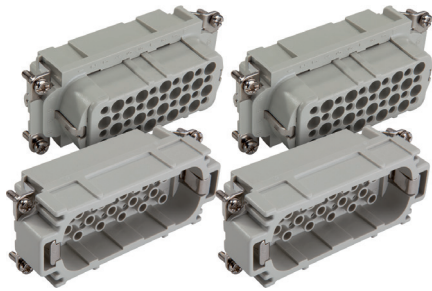

contacts sold separately, see below

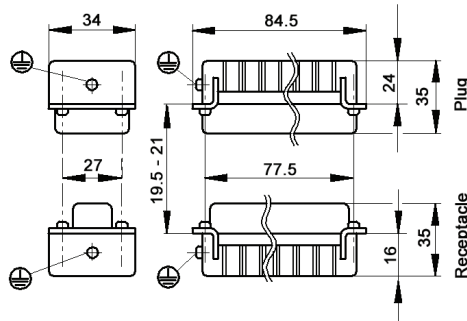

all dimensions are in mm

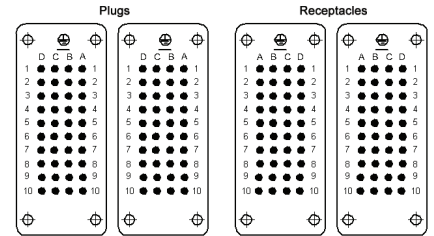

view from cable side

| Termination | Contact type | Plug | Receptacle |
|-------------------|--------------|-------------|-------------|
| crimp termination | machined | 11265200 x2 | 11266200 x2 |

x2 HD 40 inserts, use two part numbers

Compatible housing

HB 32
page 400

Approvals

1.6 mm contacts

Machined contacts for EPIC® HD series inserts

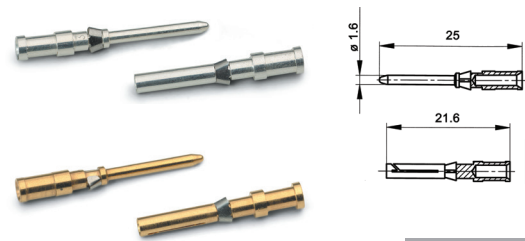

contacts sold in bags of 100

| Contact size mm² | AWG | Stripping length mm | # of marking tracks | Bag of 100 silver contacts | | Bag of 100 gold contacts | |
|---------------------|---------|------------------------|---------------------|----------------------------|----------|--------------------------|----------|
| | | | | pin | socket | pin | socket |
| 0.14 - 0.37 | 26 - 22 | 8 | 1 | 13162000 | 13163000 | 13162500 | 13163500 |
| 0.5 | 20 | 8 | 2 | 13162100 | 13163100 | 13162600 | 13163600 |
| 0.75 - 1.0 | 18 | 8 | 3 | 13162200 | 13163200 | 13162700 | 13163700 |
| 1.5 | 16 | 8 | 4 | 13162300 | 13163300 | 13162800 | 13163800 |
| 2.5 | 14 | 8 | 5 | 13162400 | 13163400 | 13162900 | 13163900 |

Contact tools

| | | | | | | | |
|--|-------------------------|--|-------------------------|--|----------------------|--|---------------------------|
| | Crimp tool: 11147000 | | Crimp dies: 11147100 | | Locator: 11147200 | | Removal tool: 11161000 |
|--|-------------------------|--|-------------------------|--|----------------------|--|---------------------------|

If not otherwise specified, all values relating to the product are nominal values. Photographs are not to scale and are not true representations of the products in question.

EPIC® HD 80

Crimp-terminated for stamped & formed contacts: 250V, 10A

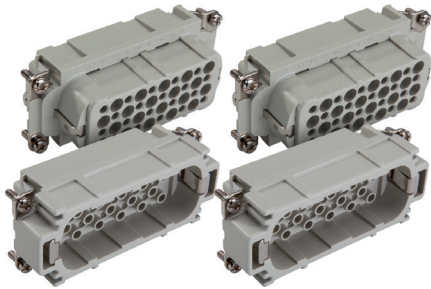

contacts sold separately, see below

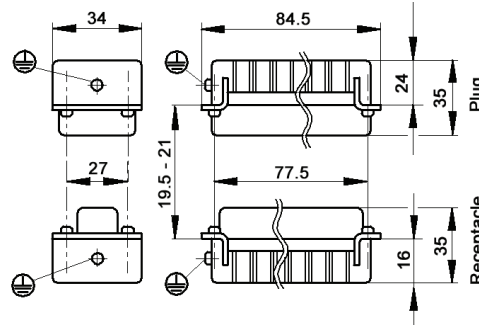

all dimensions are in mm

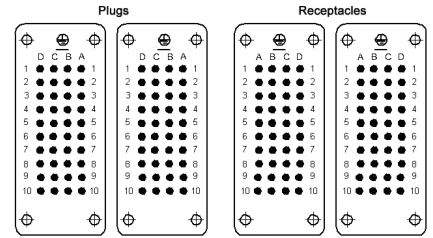

view from cable side

| Termination | Contact type | Plug | Receptacle |
|-------------------|------------------|-------------|-------------|
| crimp termination | stamped & formed | 11265000 x2 | 11266000 x2 |

x2 HD 40 inserts, use two part numbers

Compatible housing



HB 32
page 400

Approvals





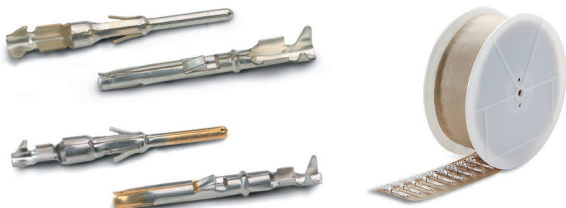

1.6 mm contacts

Stamped & formed contacts for EPIC® HD series inserts



contacts sold in bags of 100 or 1 reel

Contact tools

| | | |
|--|---|---|
|  Crimp tool: 11147000 |  Locator: 11147300 |  Removal tool: 11161000 |
|  Crimp dies: 0.14 - 0.5 mm ² : 11147170 0.5 - 1.5 mm ² : 11147180 1.5 - 2.5 mm ² : 11147190 |  Crimp tool, die & locator: 0.14 - 0.5 mm ² : 11147004 0.5 - 1.5 mm ² : 11147005 1.5 - 2.5 mm ² : 11147006 | |

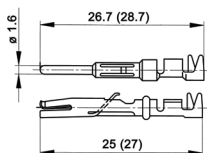

| Contact size mm ² AWG | Stripping length mm | Bag of 100 silver contacts | | Bag of 100 gold contacts | | Reel of 100 silver contacts: left-hand feed | | Reel of 200 silver contacts: left-hand feed | | |
|-------------------------------------|------------------------|----------------------------|----------|--------------------------|----------|--|----------|--|----------|----------|
| | | pin | socket | pin | socket | pin | socket | pin | socket | |
| 0.14 - 0.5 | 26 - 20 | 2.5 - 0.5 | 11241100 | 11231100 | 11243100 | 11233100 | — | — | 11240700 | 11230700 |
| 0.5 - 1.5 | 20 - 16 | 3.5 - 0.5 | 11221000 | 11236100 | 11221300 | 11238100 | — | — | 11220700 | 11235700 |
| 1.5 - 2.5 | 16 - 14 | 3.5 - 0.5 | 11223500 | 11228500 | — | — | 11223000 | 11228000 | — | — |

| Contact size mm ² AWG | Stripping length mm | Reel of 2000 silver contacts: right-hand feed | | Reel of 2000 gold contacts: right-hand feed | | Reel of 2000 silver contacts: left-hand feed | | Reel of 2000 gold contacts: left-hand feed | | |
|-------------------------------------|------------------------|--|----------|--|----------|---|----------|---|----------|----------|
| | | pin | socket | pin | socket | pin | socket | pin | socket | |
| 0.14 - 0.5 | 26 - 20 | 2.5 - 0.5 | 11240000 | 11230000 | — | — | 11240400 | 11230400 | 11240500 | 11230500 |
| 0.5 - 1.5 | 20 - 16 | 3.5 - 0.5 | 11220000 | 11235000 | 11220100 | 11235200 | 11226000 | 11226500 | — | — |
| 1.5 - 2.5 | 16 - 14 | 3.5 - 0.5 | — | — | — | — | 11222700 | 11227700 | — | — |

If not otherwise specified, all values relating to the product are nominal values. Photographs are not to scale and are not true representations of the products in question.

EPIC® HD 128

Crimp termination for machined contacts: 250V, 10A

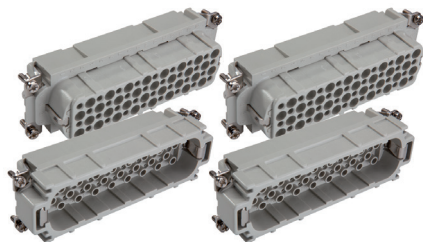

contacts sold separately, see below

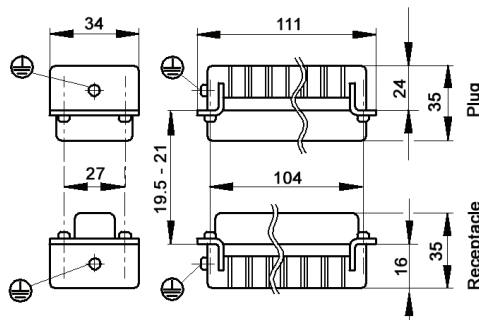

all dimensions are in mm

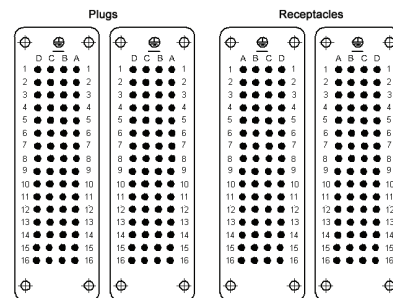

view from cable side

| Termination | Contact type | Plug | Receptacle |
|-------------------|--------------|-------------|-------------|
| crimp termination | machined | 11272000 x2 | 11273000 x2 |

x2 HD 64 inserts, use two part numbers

Compatible housing



HB 48
page 402

Approvals



1.6 mm contacts

Machined contacts for EPIC® HD series inserts

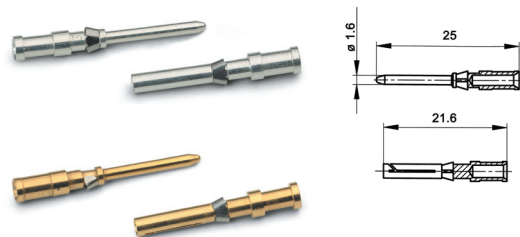

contacts sold in bags of 100

| Contact size | | Stripping length mm | # of marking tracks | Bag of 100 silver contacts | | Bag of 100 gold contacts | |
|--------------|---------|---------------------|---------------------|----------------------------|----------|--------------------------|----------|
| mm² | AWG | | | pin | socket | pin | socket |
| 0.14 - 0.37 | 26 - 22 | 8 | 1 | 13162000 | 13163000 | 13162500 | 13163500 |
| 0.5 | 20 | 8 | 2 | 13162100 | 13163100 | 13162600 | 13163600 |
| 0.75 - 1.0 | 18 | 8 | 3 | 13162200 | 13163200 | 13162700 | 13163700 |
| 1.5 | 16 | 8 | 4 | 13162300 | 13163300 | 13162800 | 13163800 |
| 2.5 | 14 | 8 | 5 | 13162400 | 13163400 | 13162900 | 13163900 |

Contact tools



Crimp tool:
11147000



Crimp dies:
11147100



Locator:
11147200



Removal tool:
11161000

If not otherwise specified, all values relating to the product are nominal values. Photographs are not to scale and are not true representations of the products in question.

EPIC® HD 128

Crimp-terminated for stamped & formed contacts: 250V, 10A



contacts sold separately, see below

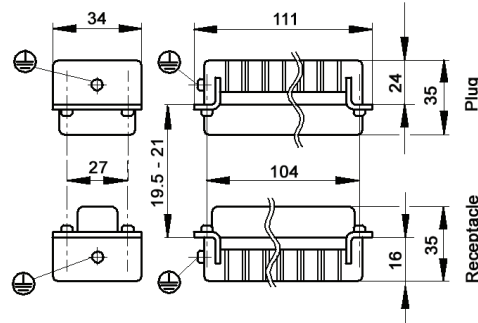

all dimensions are in mm

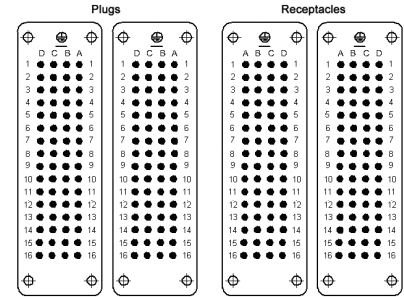

view from cable side

| Termination | Contact type | Plug | Receptacle |
|-------------------|------------------|------------|------------|
| crimp termination | stamped & formed | 1127000 x2 | 1127100 x2 |

x2 HD 64 inserts, use two part numbers

Compatible housing



HA 48
page 421

Approvals





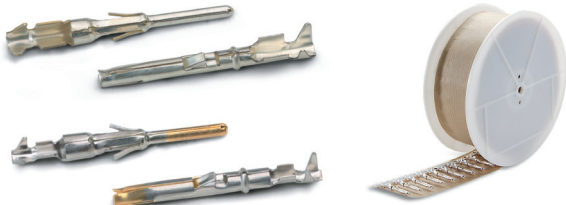

1.6 mm contacts

Stamped & formed contacts for EPIC® HD series inserts



contacts sold in bags of 100 or 1 reel

Contact tools

| | | |
|--|---|---|
|  Crimp tool: 11147000 |  Locator: 11147300 |  Removal tool: 11161000 |
|  Crimp dies: 0.14 - 0.5 mm ² : 11147170 0.5 - 1.5 mm ² : 11147180 1.5 - 2.5 mm ² : 11147190 |  Crimp tool, die & locator: 0.14 - 0.5 mm ² : 11147004 0.5 - 1.5 mm ² : 11147005 1.5 - 2.5 mm ² : 11147006 | |

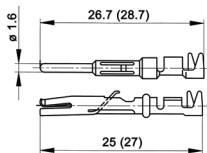

| Contact size mm ² AWG | Stripping length mm | Bag of 100 silver contacts | | Bag of 100 gold contacts | | Reel of 100 silver contacts: left-hand feed | | Reel of 200 silver contacts: left-hand feed | | |
|-------------------------------------|------------------------|----------------------------|----------|--------------------------|----------|--|----------|--|----------|----------|
| | | pin | socket | pin | socket | pin | socket | pin | socket | |
| 0.14 - 0.5 | 26 - 20 | 2.5 - 0.5 | 11241100 | 11231100 | 11243100 | 11233100 | — | — | 11240700 | 11230700 |
| 0.5 - 1.5 | 20 - 16 | 3.5 - 0.5 | 11221000 | 11236100 | 11221300 | 11238100 | — | — | 11220700 | 11235700 |
| 1.5 - 2.5 | 16 - 14 | 3.5 - 0.5 | 11223500 | 11228500 | — | — | 11223000 | 11228000 | — | — |

| Contact size mm ² AWG | Stripping length mm | Reel of 2000 silver contacts: right-hand feed | | Reel of 2000 gold contacts: right-hand feed | | Reel of 2000 silver contacts: left-hand feed | | Reel of 2000 gold contacts: left-hand feed | | |
|-------------------------------------|------------------------|--|----------|--|----------|---|----------|---|----------|----------|
| | | pin | socket | pin | socket | pin | socket | pin | socket | |
| 0.14 - 0.5 | 26 - 20 | 2.5 - 0.5 | 11240000 | 11230000 | — | — | 11240400 | 11230400 | 11240500 | 11230500 |
| 0.5 - 1.5 | 20 - 16 | 3.5 - 0.5 | 11220000 | 11235000 | 11220100 | 11235200 | 11226000 | 11226500 | — | — |
| 1.5 - 2.5 | 16 - 14 | 3.5 - 0.5 | — | — | — | — | 11222700 | 11227700 | — | — |

If not otherwise specified, all values relating to the product are nominal values. Photographs are not to scale and are not true representations of the products in question.