

52220000	<b>DATA SHEET</b>	
Valid from: 03.07.2018	<b>SKINTOP® CUBE</b>	

The **SKINTOP® CUBE** multi cable bushing system is made up of just a frame (**SKINTOP® CUBE FRAME**) and flexible clip sealing modules (**SKINTOP® CUBE MODULES**). It is able to assemble the **SKINTOP® CUBE** on 16- and 24-pole connector openings and is used as an entry in an enclosure for converted cables and cords with different diameters. The system offers strain relief, protection class and protection against vibration. During the removing of the modules remains the frame on the housing.



**Material:**

**SKINTOP® CUBE FRAME**

Frame and down holder: Glass balls reinforced

Polyamide

Flat sealing: CR

**SKINTOP® CUBE MODULE**

Clip module: Special Polypropylene V0

Sealing: LSE2

**Technical features:**

Protection class: IP64 acc. to EN 60529  
Type 1 and Type 5 acc. to UL50E

Strain relief: Retention acc. to EN 50262

Temperature range: -20°C up to +80°C

Colour: Black (RAL9005)

Max. cable inlets: 8 by SKINTOP® CUBE FRAME 16  
10 by SKINTOP® CUBE FRAME 24

**Approvals:**



**Other characteristics:**

Good chemical resistance (oil, cleaning agents...)  
UV and ozone resistant  
Permanent protection against vibration  
Frame mountable from in- and outside, fewer parts through huge, variable clamping ranges.  
Flammability HB / V-0 acc. to UL94

**Norm references:**

Retention in acc. to DIN EN 62444  
Protection class in acc. to DIN EN 60529

**Suitable accessories:**

SKINTOP® BRUSH ADD-ON 24

Creator: M. Wegerer /PDP Released: DAMU1/PDP	Document: DB52220000EN Version: 08	Page 1 of 3
---	---------------------------------------	-------------

### SKINTOP® CUBE FRAME

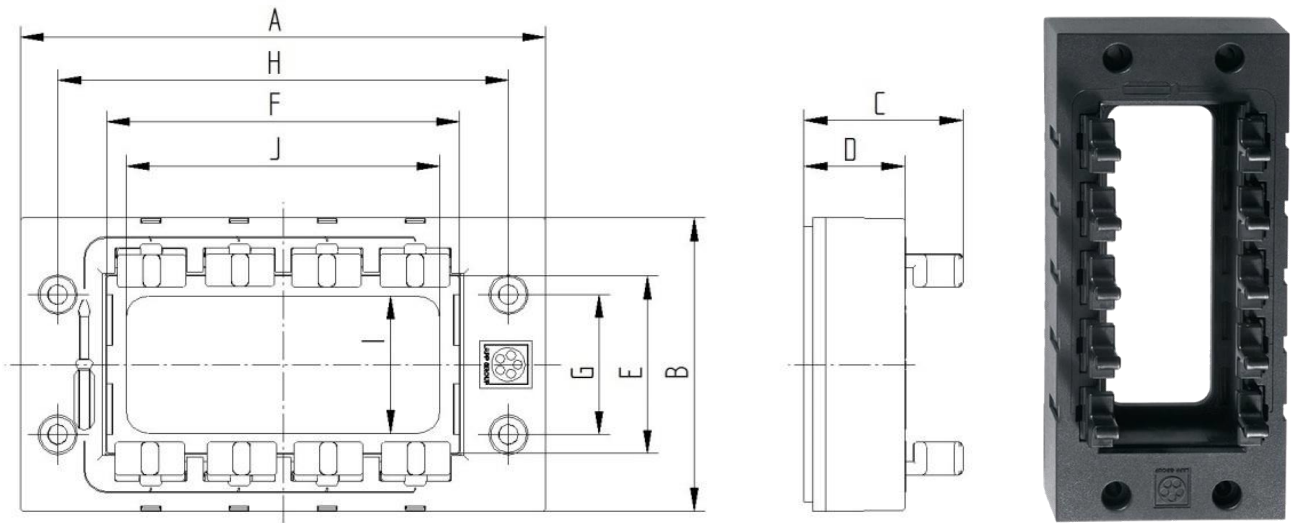

FRAME	A [mm]	B [mm]	C min. [mm]	C max. [mm]	D [mm]	E [mm]	F [mm]	G [mm]	H [mm]	I [mm]	J [mm]	Article No.
16-pole	120	67	37	46	23	40,5	80,7	32	103	31,4	72	52220000
24-pole	145	67	37	46	23	40,5	100,8	32	130	31,4	92	52220001

SKINTOP® CUBE FRAME 16  
Panel cut-out for 16-pole connector

SKINTOP® CUBE FRAME 24  
Panel cut-out for 24-pole connector

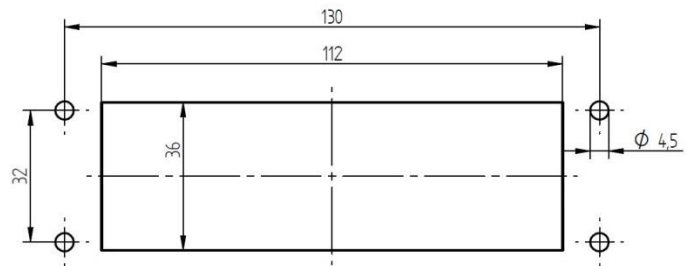
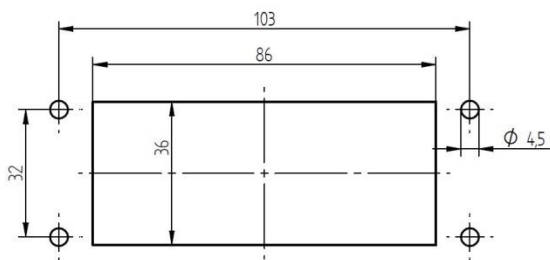

52220000	<b>DATA SHEET</b>	
Valid from: 03.07.2018	<b>SKINTOP® CUBE</b>	

### SKINTOP® CUBE MODULE

#### SKINTOP® CUBE MODULE 20x20 / 40x40

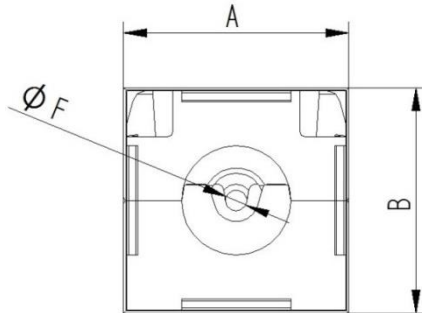

Article number	Article designation	Size A x B [mm]	Clamping range ØF [mm]
52220004	SKINTOP® CUBE MODULE 20x20 BLIND	20 x 20	1 - 3
52220002	SKINTOP® CUBE MODULE 20x20 SMALL	20 x 20	4 - 6
52220003	SKINTOP® CUBE MODULE 20x20 LARGE	20 x 20	6 - 9
52220005	SKINTOP® CUBE MODULE 40x40 SMALL	40 x 40	9 - 12
52220006	SKINTOP® CUBE MODULE 40x40 LARGE	40 x 40	12 - 16
52220007	SKINTOP® CUBE MODULE 40x40 BLIND	40 x 40	

#### SKINTOP® CUBE MODULE ASI BUS

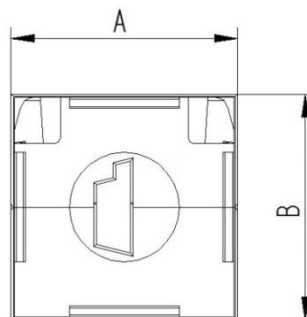

Article number	Article designation	Size A x B [mm]	Clamping range ØF [mm]
52220040	SKINTOP® CUBE MODULE 20x20 ASI BUS	20 x 20	ASI BUS

For more information please see our current catalogue. Please do not hesitate to contact our laboratory if there are any questions regarding resistance against aggressive agents and special oil.

Creator: M. Wegerer /PDP Released: DAMU1/PDP	Document: DB52220000EN Version: 08	Page 3 of 3
---	---------------------------------------	-------------