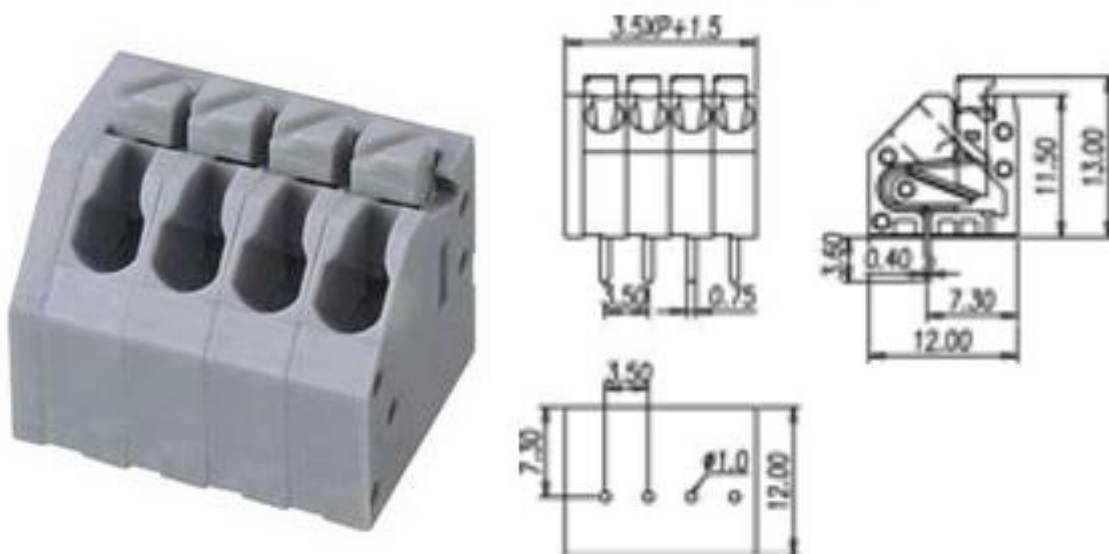

## Datasheet

**RS Pro 3304 Series 3.5mm Pitch Straight PCB Terminal Block with Push In Termination, PCB Mount, 4 Way**RS Stock No: **874-5455****Product Details**

RS Pro 4-way straight PCB terminal block comes with push in termination. This screwless PCB terminal block has a 3.5 mm pitch and a 300 V 2 A electrical ratings. The PCB terminal block features screwless cage clamp terminals that accept a wire size of 28 to 16 AWG.

**Specifications:**

Body Orientation	Straight
Colour	Grey
Current Rating	7 A (UL), 8 A (IEC)
Depth	12.9 mm
Gender	Female
Length	15.5 mm
Material	Nylon 66
Mounting Type	PCB
Number of Contacts	4
Number of Rows	1
Pitch	3.5 mm
Termination Method	Push In
Type	PCB Terminal Block
Voltage Rating	300 V (UL), 450 V (IEC)
Width	12.1 mm
American Wire Gauge	16 to 26 AWG
Insulation Withstands Voltage	2000 V ac
Operating Temperature Range	-40 to +105°C
Insulation Resistance	500 mΩ
Flammability Rating	UL 94 V-0