



Datasheet

RS PRO

Stock numbers:

1774502

1774506

1774507

1774508

EN



- ◆ MD7 is a quiet and powerful actuator
- ◆ Input voltage : 24V DC
- ◆ Max. load : 6000N (push) / 4000N (pull)
- ◆ Max. current : 3A @ 24V DC
- ◆ Max. speed at full load : 8.2mm/sec @ 3000N
- ◆ Stroke : 50 ~ 400 mm
- ◆ Duty cycle : 10% or 2 min continuous operation in 20 min.
- ◆ IP Protection level : IP54
- ◆ Color : RAL 7035
- ◆ Certified : EN60601-1-2
- ◆ Noise level : Í
- ◆ Preset limit switches

RS Number	Vendor Part Number	Push Max. (N)	Pull Max. (N)	Speed (mm/s)		Voltage (DC)	Stroke (mm)
				No load	Full load		
1774502	MD7-24-F8-388.588-C52	3000	3000	11.0	8.2	24	200
1774506	MD7-24-F8-388.488-C52	3000	3000	11.0	8.2	24	100
1774507	MD7-24-F8-488.788-C52	3000	3000	11.0	8.2	24	400
1774508	MD7-24-F8-288.388-C52	3000	3000	11.0	8.2	24	100

Current vs. Load

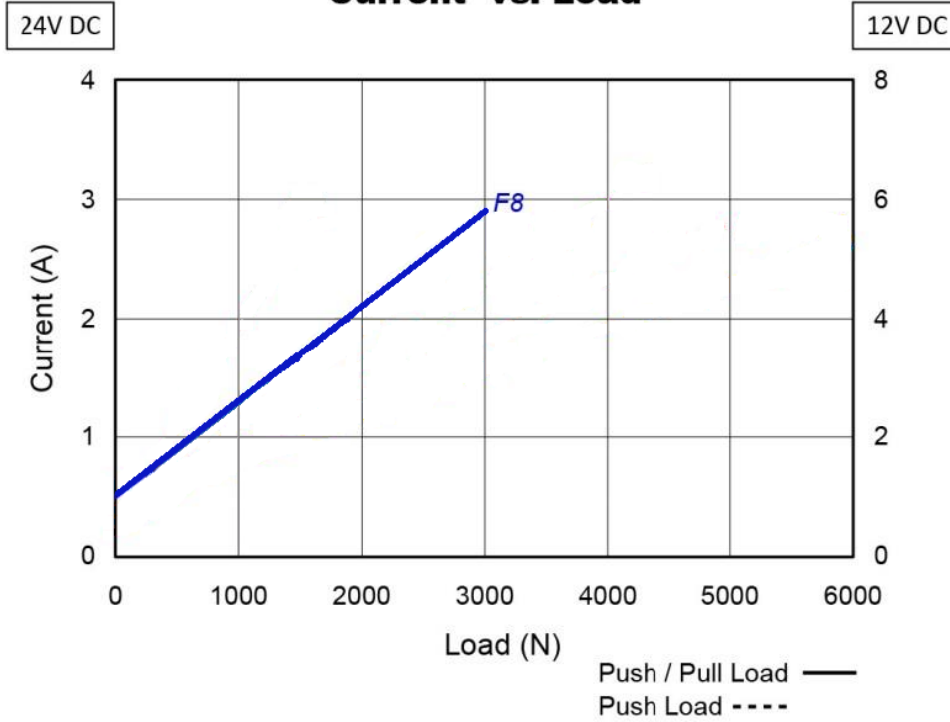

Speed vs. Load

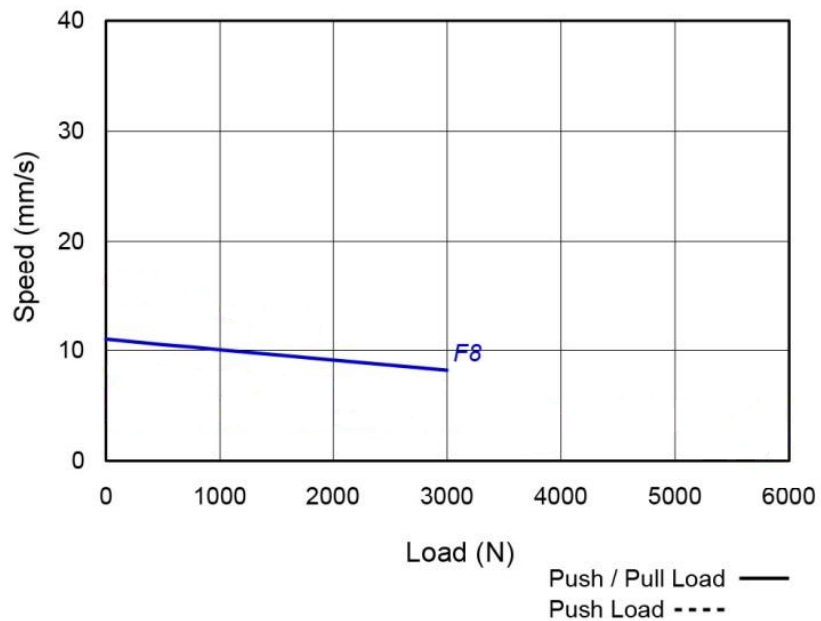

Model No.	Push Max. (N)	Pull Max. (N)	Speed (mm/s)		Current (A)			
			No load	Full load	No load		Full load	
					12V	24V	12V	24V
MD7-XX-F3- XXX.XXX	6000	4000	4.1	2.8	1.2	0.6	5.2	2.6
MD7-XX-A4- XXX.XXX	6000	4000	4.2	2.9	0.8	0.4	5.4	2.7
MD7-XX-F4- XXX.XXX	5000	4000	5.5	4.4	0.8	0.4	5.6	2.8
MD7-XX-A6- XXX.XXX	4000	4000	6.2	3.8	0.4	0.2	6.0	3.0
MD7-XX-F6- XXX.XXX	3000	3000	8.2	6.6	1.0	0.5	5.6	2.8
MD7-XX-A8- XXX.XXX	3000	3000	8.3	5.0	0.6	0.3	5.4	2.7
MD7-XX-F8- XXX.XXX	3000	3000	11.0	8.2	1.0	0.5	5.8	2.9
MD7-XX-AG- XXX.XXX	1500	1500	16.6	12.2	0.4	0.2	5.6	2.8

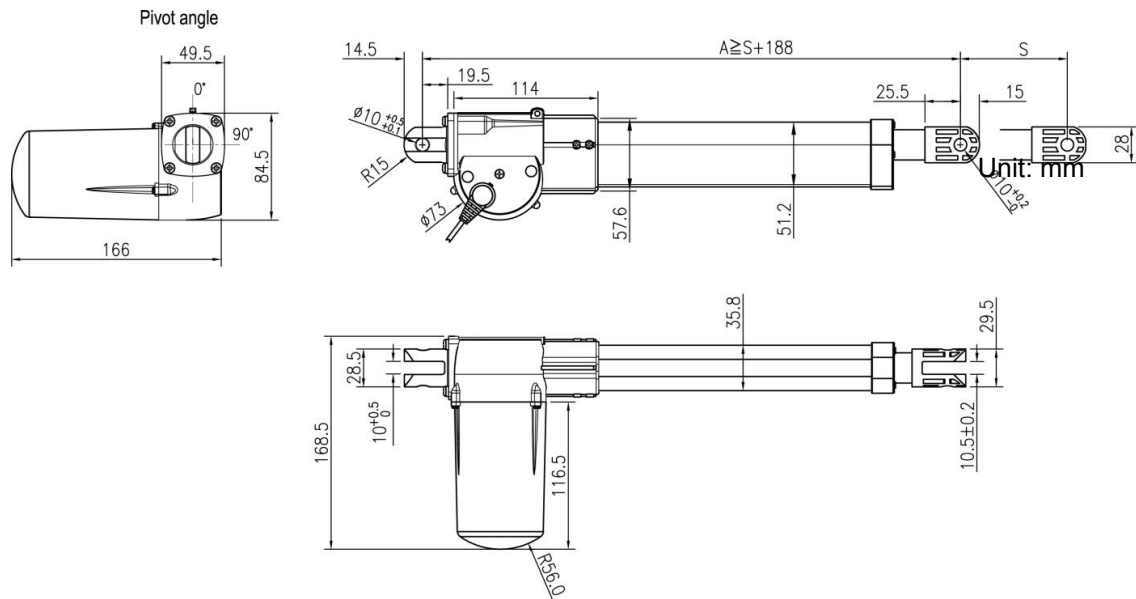

◆ Front Connector



◆ Rear Connector

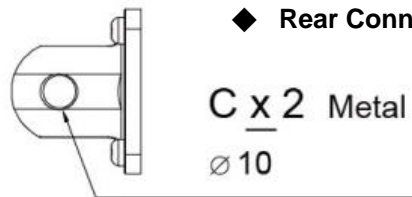

- ◆ Available stroke (S) range = 50~300mm
- ◆ Retracted length (A)

Front connector	Standard
C5x	$A \geq \text{Stroke} + 188\text{mm}$

Ordering Key

MD7-□□-□□-□□□.□□□-C□□

Input Voltage

24 : 24V DC

Motor and Spindle Code

F8

(Refer to Performance Data)

Retracted Length

(Refer to paragraph Dimensions)

Extended Length

(Refer to paragraph Dimensions)

Front Connector

8 : Metal

Rear Connector

2 : Metal