







3.1 Overview of types, sizes and available options

MR Carriages



Product overview MR Carriages

							
	A standard	B standard, long	C compact, high	D compact, high, long	E compact, high, for lateral fixation	F compact	G compact, long
Buildsizes / Carriage build forms							
Size 25	MR W 25-A	MR W 25-B	MR W 25-C	MR W 25-D	MR W 25-E	MR W 25-F	MR W 25-G
Size 35	MR W 35-A	MR W 35-B	MR W 35-C	MR W 35-D	MR W 35-E		
Size 45	MR W 45-A	MR W 45-B	MR W 45-C	MR W 45-D		MR W 45-F	
Size 55	MR W 55-A	MR W 55-B	MR W 55-C	MR W 55-D			MR W 55-G
Size 65	MR W 65-A	MR W 65-B	MR W 65-C	MR W 65-D			
Size 100	MR W 100-A	MR W 100-B					
Features							
Screwable from above	●	●	●	●		●	●
Screwable from below	●	●					
Screwable from the side					●		
For high loads and moments		●		●			●
For medium loads and moments	●		●		●	●	
For limited installation space						●	●



Available options for MR Carriages

Details see chapter 2



Accuracy

-  **G0** Highly accurate
-  **G1** Very accurate
-  **G2** Accurate
-  **G3** Standard



Load

-  **V1** Low
-  **V2** Medium
-  **V3** High







Reference side

-  **R1** Ref. at bottom
-  **R2** Ref. on top

Coating



-  **CN** None
-  **CH** Hard chromium

Lube connections

-  **S10** Left center
-  **S20** Right center
-  **S11** Top left
-  **S21** Top right
-  **S12** Lower left side
-  **S22** Lower right side

-  **S13** Upper left side
-  **S23** Upper right side
-  **S32** Left side
-  **S42** Right side

Lubrication

-  **LN** Oil protect
-  **LG** Grease protect
-  **LV** Full greasing

Available accessories for MR Carriages

Details see chapter 3.3 and 2.1

Additional wipers
Front plates

Bellows
Lube nipples

Assembly rails
Lube adapters

Lubrication plates

3.2 Technical data and options

MR Size 25

MR S 25 Drawings

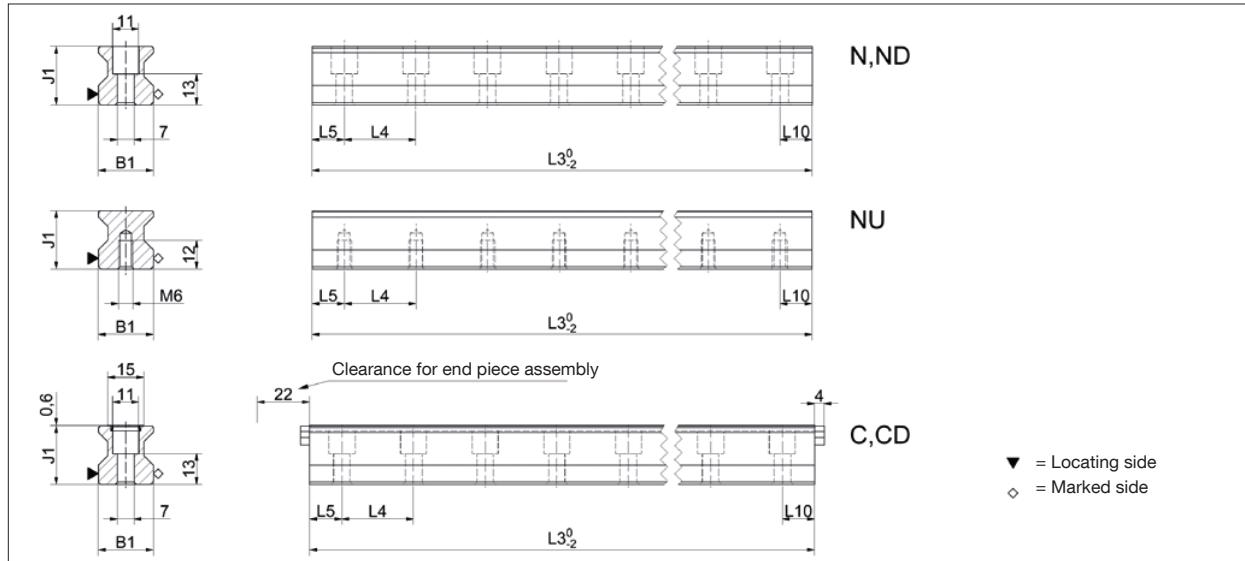

MR W 25 Drawings

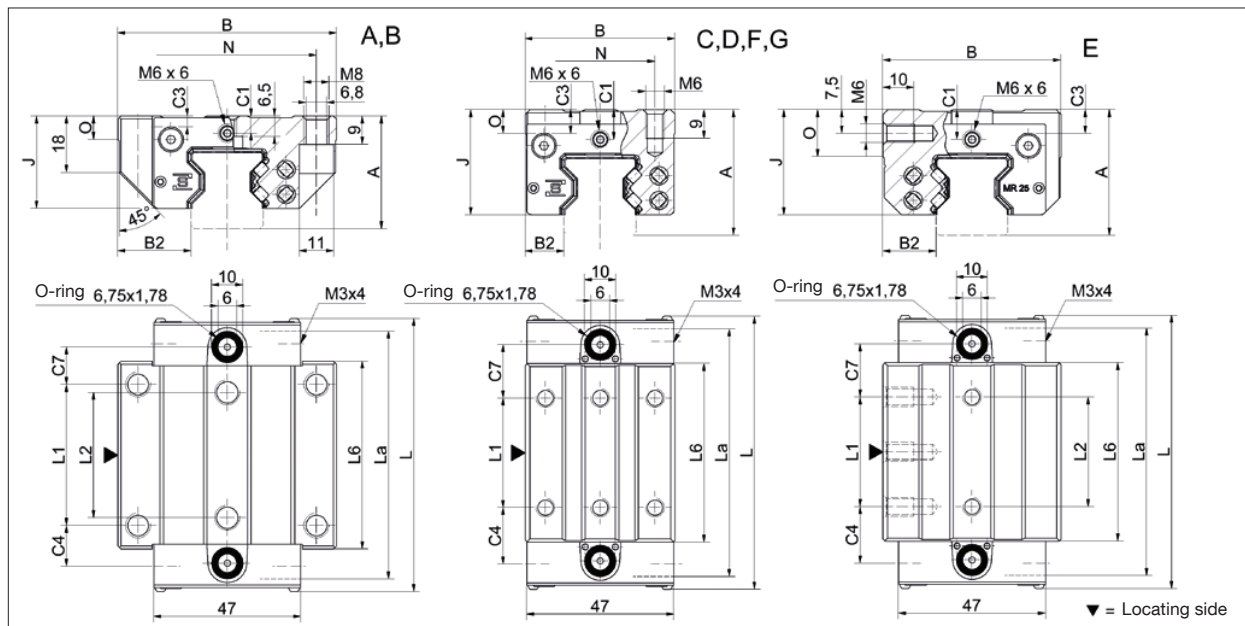

MR W 25 Rigidity diagram

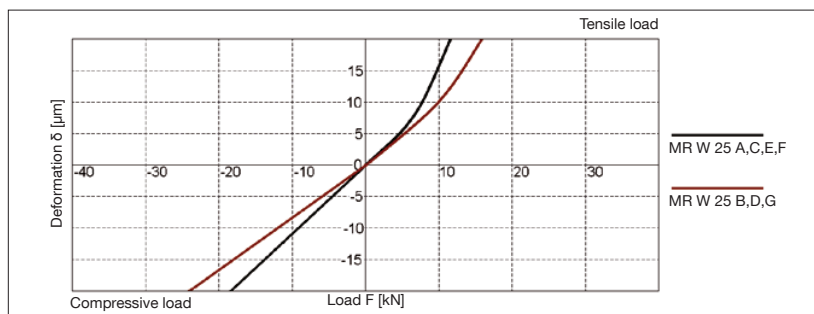

MR W 25 Load rating

