

ASi-3 PROFIBUS Gateways with integrated Safety Monitor

ASi-3 Gateways with integrated Safety Monitor

2 / 1 ASi Master, PROFIBUS Slave

1 ASi Safety Monitor for 2 ASi networks

- Operation using a single Monitor configuration!
Monitor processes safety slaves on two ASi networks
Coupling between the two networks superfluous



(Figure similar)

Up to 32 release circuits

- up to 6 CAT4, SIL 3 safe output circuits on the Monitor
safe relays or electronic safe outputs

Safe ASi outputs are supported

- up to 32 independent ASi outputs
Multiple safe ASi outputs possible via a single ASi address

Safe speed and standstill monitoring

Applications up to category 4/PLe/SIL 3

Chip card for storage of configuration data



Figure	Type	Inputs safety, expandable to	Outputs Safety, SIL 3, cat. 4	Safety outputs, independent according to SIL 3, expandable to	Safety communication	Number of ASi networks, number of ASi Master ⁽¹⁾	1 power supply, 1 gateway for 2 ASi networks, inexpensive power supplies ⁽²⁾	Diagnostic and configuration interface ⁽³⁾	Article no.
	Safety PROFIBUS	max. 62 x 2 channels, max. 1922 in max. configuration	6 release circuits; 6 x electronic safe outputs	max. 32, max. 992 in max. configuration	Safe Link	2 ASi networks, 2 ASi masters	yes, max. 4 A/ ASi network	Ethernet diagnostic	BWU2822
	Safety PROFIBUS	max. 31 x 2 channels, max. 1891 in max. configuration	6 release circuits; 6 x electronic safe outputs	max. 31, max. 991 in max. configuration	Safe Link	1 ASi network, 1 ASi master	yes, max. 4 A/ ASi network	Ethernet diagnostic	BWU2793
	Safety, PROFIBUS	max. 62 x 2 channels, max. 1922 in max. configuration	4 release circuits; 2 x relay, 2 x electronic safe outputs	max. 32, max. 992 in max. configuration	Safe Link	2 ASi networks, 2 ASi masters	yes, max. 4 A/ ASi network	Ethernet diagnostic	BWU2602
	Safety, PROFIBUS	max. 62 x 2 channels	4 release circuits; 2 x relay, 2 x electronic safe outputs	max. 16	-	2 ASi networks, 2 ASi masters	yes, max. 4 A/ ASi network	Ethernet diagnostic	BWU2202
	Safety, PROFIBUS	max. 62 x 2 channels	4 release circuits; 2 x relay, 2 x electronic safe outputs	max. 16	-	2 ASi networks, 1 ASi master	yes, max. 4 A/ ASi network	Ethernet diagnostic	BWU2204
	Safety, PROFIBUS	max. 62 x 2 channels	2 release circuits; 2 x 2 relay	max. 16	-	2 ASi networks, 1 ASi master	yes, max. 4 A/ ASi network	Ethernet diagnostic	BWU2206

(1) **Number of ASi networks, number of ASi Master: Safety devices:**
"Single Master": 1 ASi network, 1 ASi Master.
"Double Master": 2 ASi networks, 2 ASi Masters.
"Optional ASi Safety coupling circuit": 2 ASi networks, 1 ASi Master.

ASi-3 PROFIBUS Gateways with integrated Safety Monitor

- (2) **1 power supply, 1 gateway for 2 ASi networks, inexpensive power supplies:**
"yes, max. 4 A/ASi network": Cost-effective power for 2 ASi networks with 1 power supply (optionally supply of multiple Single Gateways by 1 power supply).
- (3) **Diagnostic and configuration interface**
"Ethernet diagnostic": Access to ASi master and safety monitor via Bihl+Wiedemann proprietary software over Ethernet diagnostics interface.
The latest version of the device description file of the gateway is available in the "Downloads" section of the respective device.

Article no.	BWU2206	BWU2202 / BWU2204	BWU2602	BWU2793 / BWU2822
Interface				
PROFIBUS interface	according to IEC 61158 / IEC 61784-1			
Baud rates	9,6 Kbaud up to 12 000 Kbaud, automatic recognition			
DP functions	imaging of the ASi slaves as I/O data of the PROFIBUS complete diagnosis and configuration via the PROFIBUS DP			
Card slot	chip card for storage of configuration data			
ASi				
ASi specification	3.0			
Cycle time	150 μ s * (number of slaves + 2)			
Operating voltage	30 V _{DC} (20 ... 31,6 V)			
ASi Power24V capability ⁽¹⁾	no		yes	
AUX				
Operating voltage	–	24 V _{DC} (19,2 ... 28,8 V)		
Max current consumption	–	1 A	7,2 A	
Display				
LCD	menu, indication of slave addresses and error messages in plain text			
LED power (green)	power ON			
LED PROFIBUS (green)	PROFIBUS communication active			
LED config error (red)	configuration error			
LED U ASi (green)	ASi voltage o.k.			
LED ASi active (green)	ASi normal operation active			
LED prg enable (green)	automatic addresses programming enabled			
LED prj mode (yellow)	configuration mode active			
LED AUX (green)	–	auxiliary power		
LEDs 1.Y1, 1.Y2, 2.Y1, 2.Y2 (EDM/Start) (yellow)	–	state of inputs: off: open on: closed		–
LEDs K1 ... K4 (green)	–	state of outputs: off: open on: closed		–
LEDs SI1 ... SI6 (yellow)	–			state of inputs: off: open on: closed
LEDs SO1 ... SO6 (yellow)	–			state of outputs: off: open on: closed

ASi-3 PROFIBUS Gateways with integrated Safety Monitor

Article no.	BWU2206	BWU2202 / BWU2204	BWU2602	BWU2793 / BWU2822
UL-specifications (UL508)				
External protection	an isolated source with a secondary open circuit voltage of $\leq 30 V_{DC}$ with a 3 A maximum over current protection. Over current protection is not required when a Class 2 source is employed.			
In general	UL mark does not provide UL certification for any functional safety rating or aspects of the above devices.			
cTÜVus	the devices <ul style="list-style-type: none"> • BWU2202 • BWU2204 • BWU2206 from Bihl + Wiedemann GmbH were safety certified by TÜV Rheinland of North America, Inc. according to UL-standards and meet the safety requirements for the North American market.			
Applied standards	EN 60529 EN 61000-6-2 EN 61000-6-4 EN 62061, SIL 3 EN 61508, SIL 3 EN ISO 13849-1, performance-level e			
Environment				
Operating altitude	max. 2000 m			
Ambient temperature	0 °C ... +55 °C			
Storage temperature	-25 °C ... +85 °C			
Pollution degree	2			
Housing	stainless steel, for DIN rail mounting			
Protection category	IP20			
Tolerable loading referring to humidity	according to EN 61131-2			
Maximum tolerable shock and vibration stress	according to EN 61131-2			
Voltage of insulation	$\geq 500 V$			
Weight	800 g			
Dimensions (W / H / D in mm)	100 / 120 / 106			

(1) **ASi Power24V**

The device can be operated directly on a 24 V (PELV) power supply. The gateway has been optimized with integrated data coupling coils and adjustable self-resetting fuses for safe use of powerful 24 V power supplies.

Article no.	BWU2206	BWU2202 / BWU2204 / BWU2602	BWU2793 / BWU2822
Safety monitor			
Start delay	<10 ms		
Max. turn-off time	<40 ms		
Antivalent switches for local inputs	–		yes
Standstill monitors for local inputs	–		6 axes up to 50 Hz ⁽²⁾
Speed monitors for local inputs	–		3 to 6 axes up to 400 Hz ⁽³⁾
Connection			
Connection	COMBICON		
Length of connector cable	I/O: max. 15 m		unlimited ⁽⁴⁾
Input			
Inputs Safety, SIL3, Kat. 4	–		3 x 2 channels ⁽⁵⁾
Inputs digital, EDM	4		up to 6 standard inputs ⁽⁵⁾
Switching current	30 mA (T = 100 μ s), continuously 4 mA at 24 V		15 mA (T = 100 μ s), continuously 4 mA at 24 V
Power supply	out of ASi		out of AUX

ASi-3 PROFIBUS Gateways with integrated Safety Monitor

Article no.	BWU2206	BWU2202 / BWU2204 / BWU2602	BWU2793 / BWU2822
Output			
Number of release circuits on the monitor	2	4	6
Outputs	relay outputs (output circuits 1 and 2), each 2 current paths max. contact load ⁽¹⁾ : 3 A _{AC-15} at 30 V, 3 A _{DC-13} at 30 V	relay outputs (output circuits 1 and 2) max. contact load ⁽¹⁾ : 3 A _{AC-15} at 30 V, 3 A _{DC-13} at 30 V semiconductor outputs (output circuits 3 and 4) max. contact load: 0,5 A _{DC-13} at 30 V	semiconductor output max. contact load: 1,2 A _{DC-13} at 30 V, Σ= 7,2 A in sum ⁽⁶⁾
Power supply (semiconductor outputs)	–	out of AUX	
Test pulse (semiconductor outputs)	–	if output is on: minimum interval between 2 test pulses: 250 ms (as from Safety Version 4.3); maximum pulse width 1,5 ms	if output is on: minimum interval between 2 test pulses: 250 ms; maximum pulse width 1 ms

(1) protection via external fuse, max. 4 A semi time-lag

(2) connection at all SI or SO terminals possible.

(3) connection only at terminals SO1 ... SO6 configured as standard inputs (see "Variations of terminal configuration for BWU2793, BWU2822")

(4) loop resistance ≤ 150 Ω

(5) see "Variations of terminal configuration for BWU2793, BWU2822"

(6)

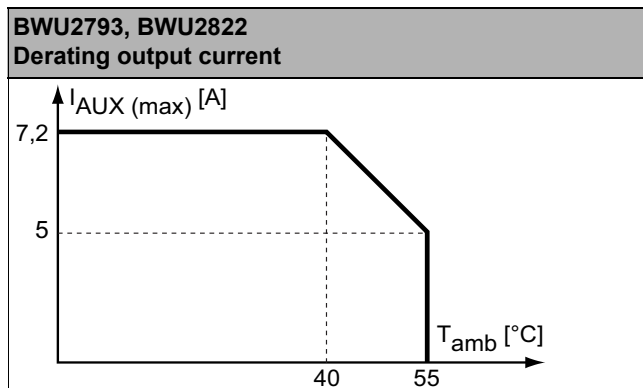

Article No.	Operating current		
	master power supply, approx 300 mA out of ASi network	master power supply, max. 300 mA out of ASi circuit 1 (approx. 70 mA ... 300 mA), max. 300 mA out of ASi circuit 2 (approx. 70 mA ... 300 mA); in sum max. 370 mA	Version „1 gateway, 1 power supply, for 2 ASi networks“, approx. 300 mA (PELV voltage)
BWU2202	–	–	•
BWU2204	–	•	–
BWU2206	–	•	–
BWU2602	–	–	•
BWU2793	–	–	•
BWU2822	–	–	•

ASi-3 PROFIBUS Gateways with integrated Safety Monitor

	BWU2202 / BWU2204 / BWU2206	BWU2602 / BWU2793 / BWU2822
Redundant power supply out of ASi: all fundamental functions of the device remain available even in case of power failure in one of the two ASi networks	–	–
Current measurement of the ASi circuits	–	•
Self-resetting adjustable fuses	–	•
ASi earth fault monitor distinguishes between ASi cable and sensor cable	–	•
In version „1 gateway, 1 power supply for 2 ASi circuits“: only 1 gateway + 1 ASi power supply is needed for both 2 ASi circuits	•	•

Safety outputs block diagram BWU2202, BWU2204, BWU2602

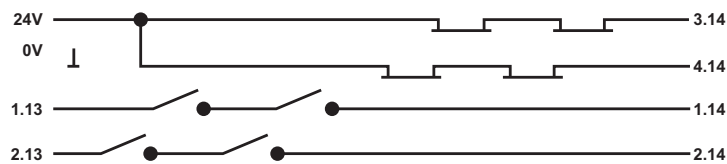

Safety outputs block diagram BWU2206

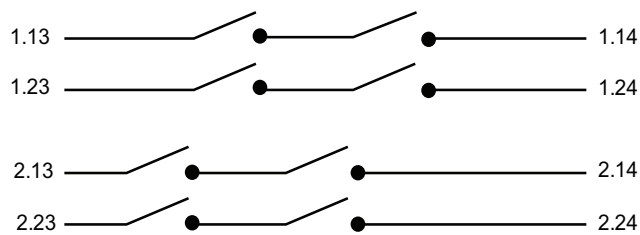

Safety outputs block diagram BWU2793, BWU2822

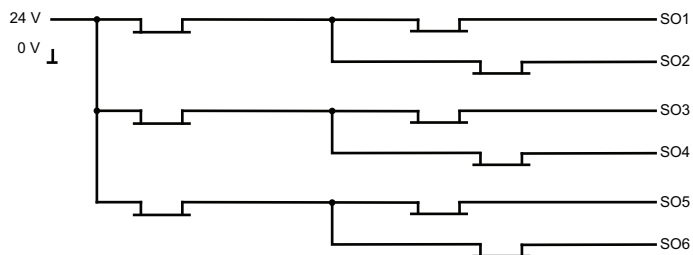

ASi-3 PROFIBUS Gateways with integrated Safety Monitor

Variations of terminal configuration for BWU2793, BWU2822

Terminal	Safe output	Safe input for mechanical contacts in combination with T1, T2 ⁽¹⁾	Safe antivalent input ⁽¹⁾	Safe electronic input ⁽¹⁾	Standard input ⁽¹⁾
SI1,2	–	•	•	•	•
SI3,4	–	•	•	•	•
SI5,6	–	•	•	•	•
SO1,2 ⁽²⁾	•	•	•	–	•
SO3,4 ⁽²⁾	•	•	•	–	•
SO5,6 ⁽²⁾	•	•	•	–	•

⁽¹⁾ Inputs may only be supplied by the same 24 V source as the device itself.

⁽²⁾ If outputs are configured as inputs, the input current has to be limited by an external element at ≤ 100 mA

Connections: Gateway + Safety Monitor

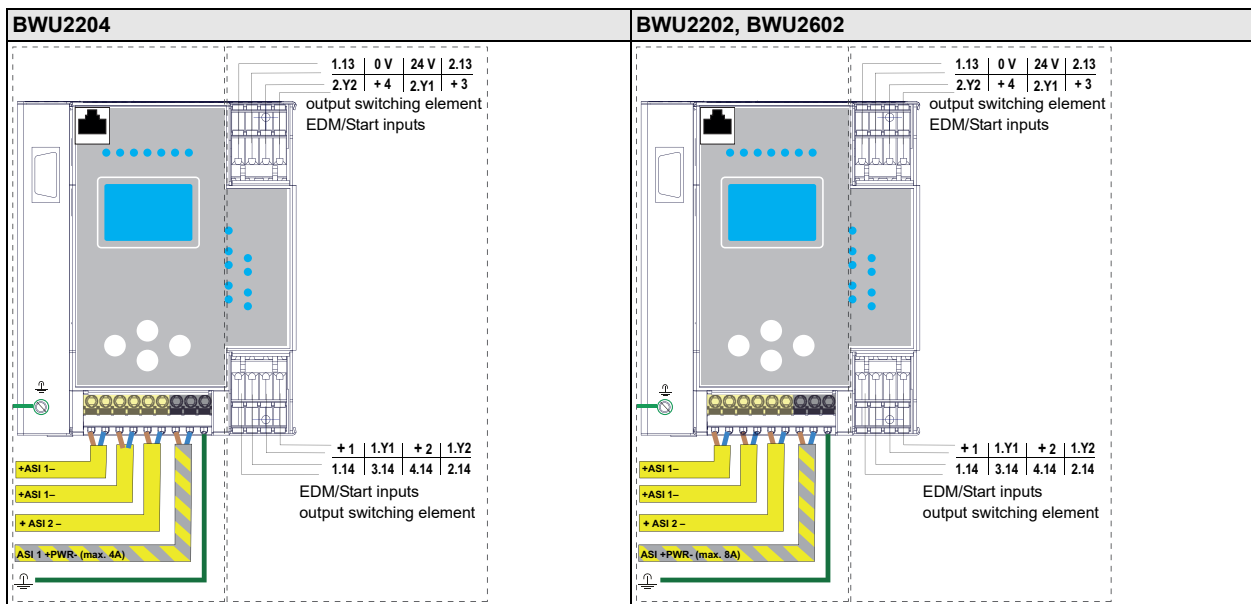

ASi-3 PROFIBUS Gateways with integrated Safety Monitor

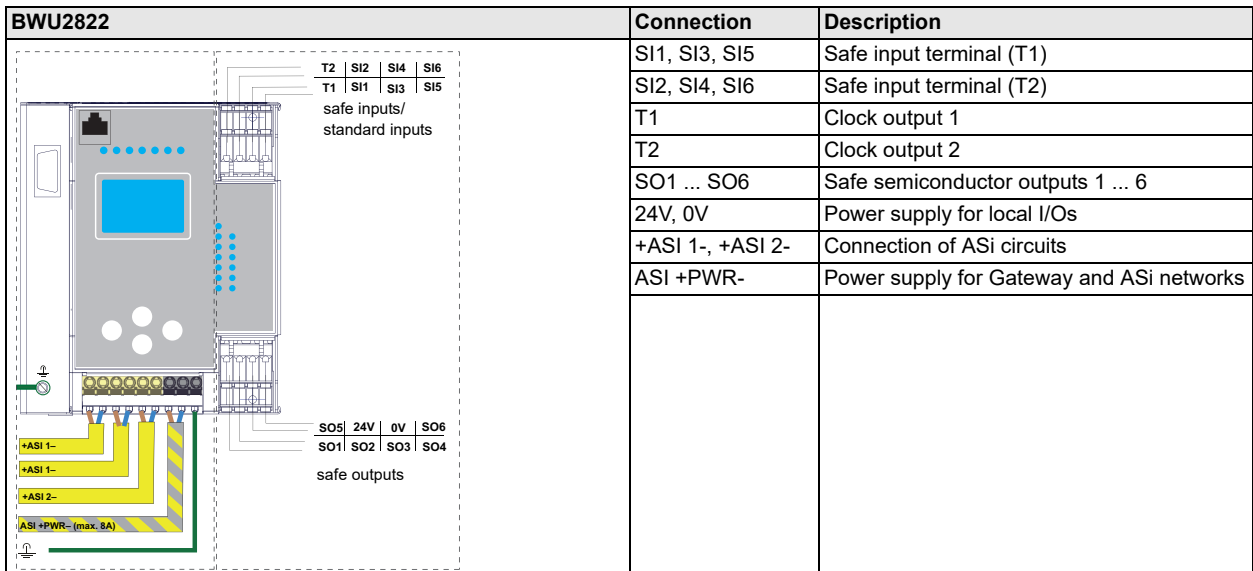
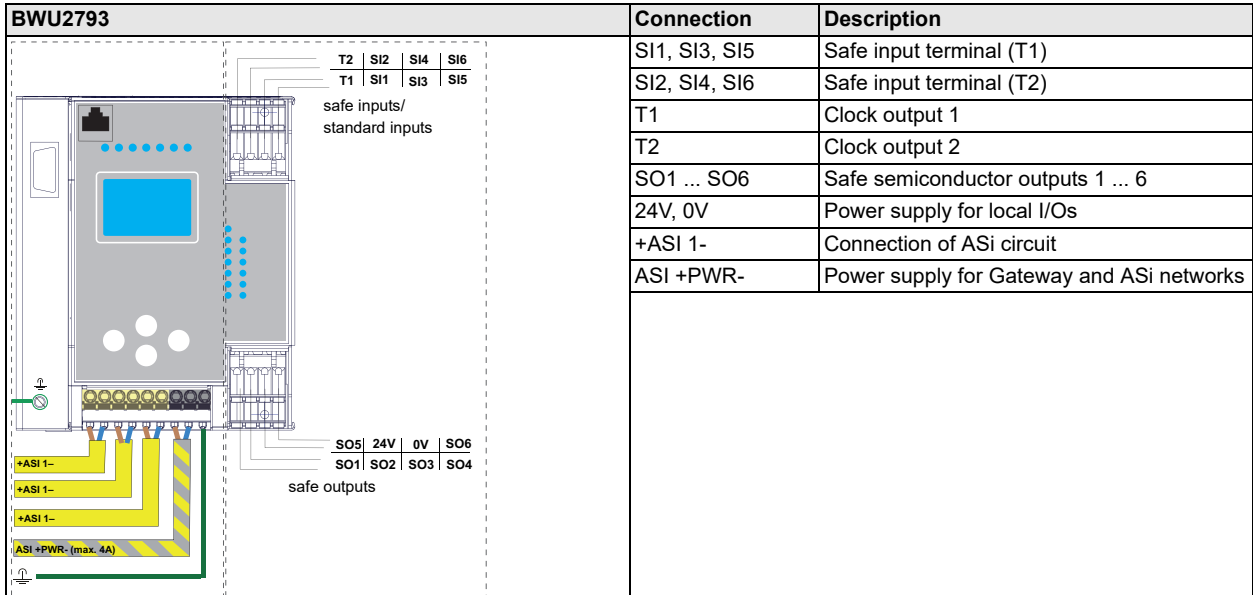
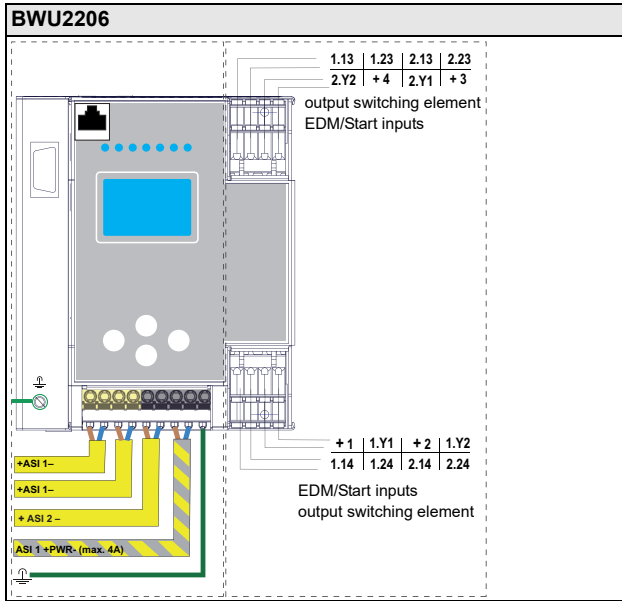

ASi-3 PROFIBUS Gateways with integrated Safety Monitor



Accessories:

- Safe contact expander, 1 or 2 independent channels (art. no. BWU2548 / BWU2539)
- PROFIBUS DP Master Simulator (art. no. BW1257)
- Bihl+Wiedemann Suite - Safety Software for Configuration, Diagnostics and Commissioning (art. no. BW2916)
- Power supplies, e.g.: ASi power supply, 4 A (art. no. BW1649), ASi power supply, 8 A (art. no. BW1997)
(further power supply units can be found at www.bihl-wiedemann.de/en/products/accessories/power-supplies)