

Excelon® design allows in-line or modular installation

High efficiency oil and particle removal

Quick release bayonet bowl

Standard visual service life indicator turns from green to red when the filter element needs to be replaced

Technical data

Fluid:

Compressed air, neutral gases
 NOTE: Contact technical support for use with other media.

Maximum pressure:

Transparent bowl: 150 psig (10 bar)
 Metal bowl: 250 psig (17 bar)
 (72) metal bowl w/autodrain: 116 psig (8 bar)

NOTE: Coalescing filters should be used in conjunction with a 5µm general purpose filter upstream to maximize filter element life and optimize performance.

Operating temperature*:

Transparent bowl: -30° to 125°F (-34° to 50°C)
 Metal bowl: -30° to 150°F (-34° to 65°C)
 * Air supply must be dry enough to avoid ice formation at temperatures below 35°F (2°C).

Filtration:

Particle removal: 0.01 µm
 Remaining oil content: 0.01 ppm mg/m3 at 70°F (21°C)

Materials

F72C

Body: zinc
 Bowl transparent: polycarbonate
 Metal: zinc
 Metal bowl liquid level indicator lens: Transparent nylon
 Element: synthetic fiber and polyurethane foam
 Elastomers: chloroprene and nitrile
 Service life indicator materials- Body: transparent nylon.
 Internal parts: acetal.
 Spring: stainless steel.
 Elastomers: nitrile, chloroprene

Materials



F73C and F74C

Body: aluminum
 Transparent bowl: polycarbonate
 Transparent with guard: polycarbonate,
 Guard: aluminum
 Metal bowl: aluminum
 Metal bowl liquid level indicator lens: Transparent nylon
 Element: synthetic fiber and polyurethane foam
 Elastomers: chloroprene and nitrile
 Mechanical service indicator materials Body: transparent nylon
 Internal parts: Acetal
 Spring: Stainless steel
 Elastomers: nitrile



Ordering information

Models listed include PTF threads, service indicator, automatic drain, and a metal bowl with liquid level indicator.

ISO Symbols	Port Size	Model	Maximum Flow* scfm (dm3/s)	Weight lb (kg)
 Automatic  Manual Drain	1/4"	F72C-2AD-AE0	9.5 (4.5)	1.2 (0.54)
	3/8"	F73C-3AD-AD0	21.2 (10.0)	1.2 (0.54)
	1/2"	F74C-4AD-AD0(std)	33.9 (16.0)	1.84 (0.83)
	1/2"	F74H-4AD-AD0 (hi-flow)	59.3 (28.0)	2.45 (1.11)
	3/4"	F74H-6AD-AD0 (hi-flow)	59.3 (28.0)	2.40 (1.10)

* Maximum flow with 90 psig (6.3 bar) inlet pressure to maintain stated oil removal performance.

Options selector

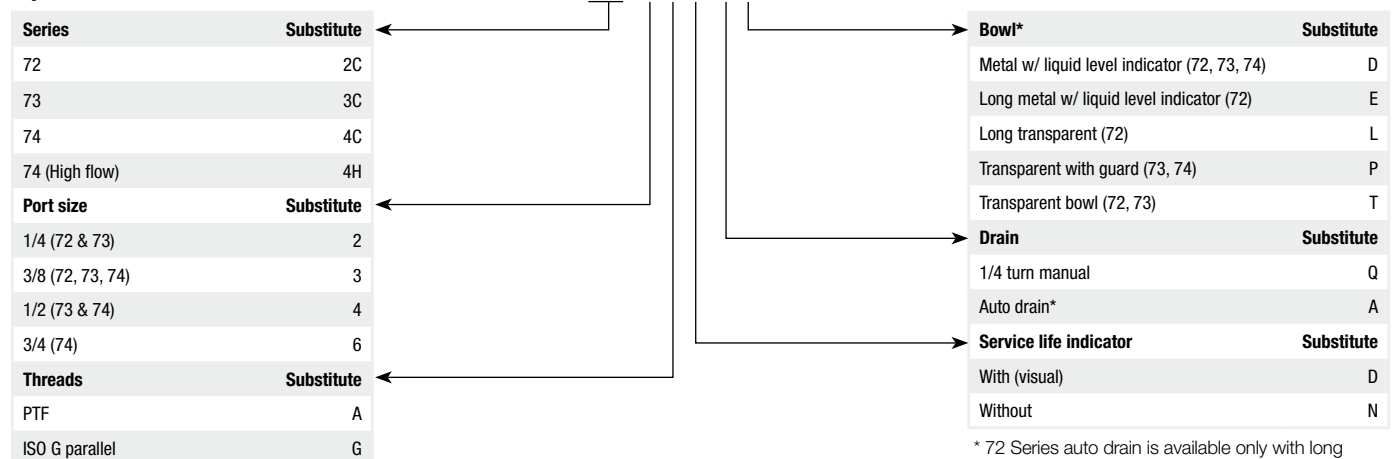

* 72 Series auto drain is available only with long bowl option.

Accessories

	Wall mounting bracket*	Quikmount pipe adapters (quantity of 1) (NPT)	Quikclamp®† (quantity of 1)	Quikclamp® and wall bracket (quantity of 1)	Visual service indicator	Electrical service life indicator	Service kit Seal and gasket	Replacement elements
F72C	4224-50	4215-02 (1/4) 4215-03 (3/8)	4214-51	4214-52			4380-500	5925-09
F73C	4424-50	4315-01 (1/4) 4315-02 (3/8) 4315-03 (1/2) 4315-04 (3/4)	4314-51	4314-52	5797-50	4020-51R	4380-602	4444-01
F74C, F74H	4324-50	4315-02 (3/8) 4315-03 (1/2) 4315-04 (3/4)	4314-51	4314-52	5797-50	4020-51R	4380-730	4344-01 (F74C) 4344-02 (F74H)

* Bracket kit does not include wall mounting screws.
† Quikclamp is patented (US patent 5372392) and foreign patents.

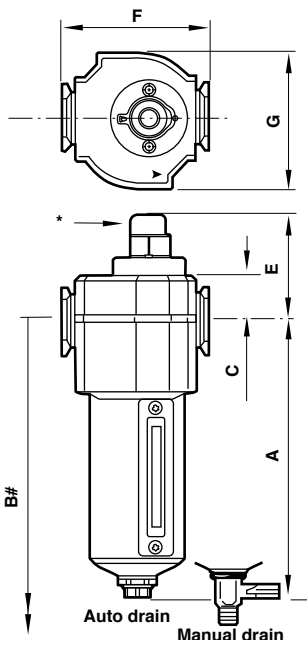

Mounting bracket

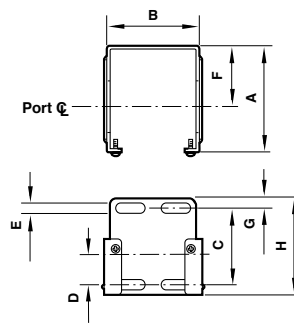

Series	A	B	C	D	E	F	G	H
72	2.36	1.65	1.54	0.73	0.16	1.50	0.24	2.01
73	2.64	2.36	1.89	0.75	0.28	1.50	0.24	2.40
74	3.11	2.72	1.97	0.79	0.20	2.01	0.24	2.40

Series	Drain type	A	B	C	E	F	G
F72C	Auto	5.51	7.52	0.75	2.09	1.97	1.89
	Manual	5.83	7.83	0.75	2.09	1.97	1.89
F73C	Auto	5.80	8.15	0.98	2.36	2.68	2.44
	Manual	6.15	8.50	0.98	2.36	2.68	2.44
F74C	Auto	6.35	9.17	0.98	2.36	3.15	2.91
	Manual	6.95	9.80	0.98	2.36	3.15	2.91
F74H	Auto	8.44	11.18	0.98	2.36	3.15	2.91
	Manual	9.04	11.81	0.98	2.36	3.15	2.91

* Standard service indicator
Minimum clearance required to remove bowl

F73

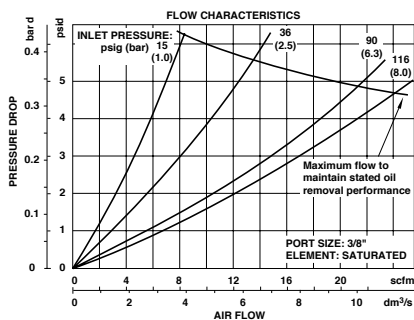

F74C

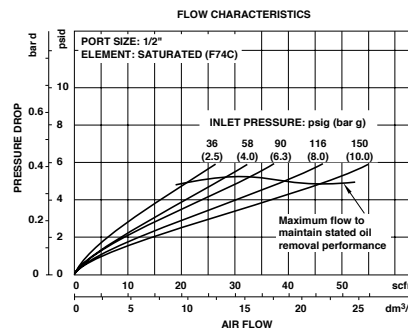

F74H

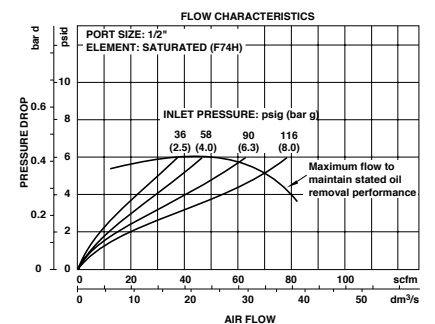

Dimensions in inches (mm)