

# ENW ENWM LASERTRONIC ELWX PROFILINE LWX

**SOLA**   
PASSION FOR PRECISION

Gebrauchsanweisung

Operating instructions

Manuel d'instructions

Instruzioni d'uso

Instrucciones de uso

Gebruiksaanwijzing

Руководство по применению

Instrukcja obsługi

Ekspluatācijas instrukcija

Lietošanas instrukcija

Uputstvo za upotrebu

Návod k použití

Manual de utilizare

**DE**

**EN**

**FR**

**IT**

**ES**

**NL**

**RU**

**PL**

**LT**

**LV**

**SR**

**CZ**

**RO**



### Scope of delivery for ENW, ENWM:

---

1. ENW, ENWM
2. AAA batteries
3. Quick start guide

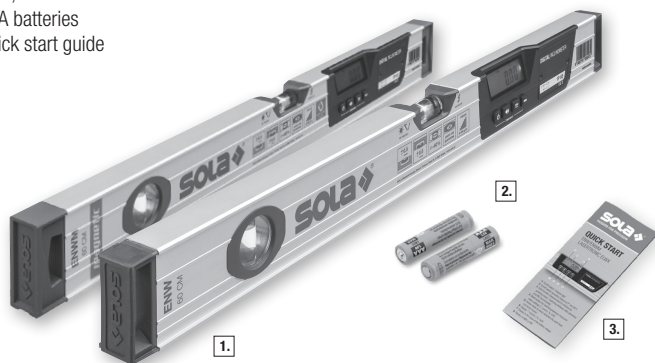

### Scope of delivery for LASERTRONIC ELWX, PROFILINE LWX:

---

1. LASERTRONIC ELWX, PROFILINE LWX
2. AAA batteries
3. Quick start guide



# ENW, ENWM, LASERTRONIC ELWX, PROFILINE LWX

## operating manual (German original version)

### About this manual

Congratulations on purchasing your new ENW, ENWM, LASERTRONIC ELWX, PROFILINE LWX! You have acquired a SOLA measurement instrument, which can make your work easier, faster and more precise. To utilize the complete functionality range of this measurement instrument, and to ensure safe operation, please observe the following instructions:

- Please read this operating manual before starting to use the device.
- Always keep the operating manual near the device.
- Only hand over the device to other persons together with the operating manual.
- Never render the attached warning signs unreadable.

### Contents

---

1. General information
2. Description
3. Technical data
4. Safety instructions
5. Laser safety / classification
6. Startup
7. Operation
8. Calibration and adjustment
9. Maintenance, storage and transportation
10. Scope of delivery and accessories
11. Troubleshooting
12. Disposal
13. Warranty
14. EC conformity declaration

# 1. General information

---

## 1.1 Signal words and their meaning

### DANGER

For an imminent danger that could lead to serious injury or death.

### WARNING

For a possibly dangerous situation that could lead to serious injury or death.

### CAUTION

For a possibly dangerous situation that could lead to slight injury or property damage.

### NOTE

For application notes and other useful information

## 1.2 Pictograms and other information

### 1.2.1 Warning signs



Warning of dangers in general

### 1.2.2 Symbole



Read instructions before use



Batteries and devices must not be disposed of with household waste



Do not throw batteries into a fire

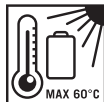

Warning signs on battery Do not heat the battery above 60 °C.



Class 2 laser device



Do not look into the laser beam!

## 2. Description

### 2.1 Device components, display and operating elements

#### 2.1.1 ENW, ENWM

1. Acrylic glass block vials
2. Gradient module
3. Gradient module battery compartment

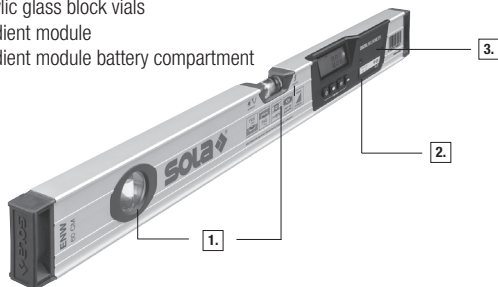

#### 2.1.2 LASERTRONIC, PROFILINE

1. Laser output aperture
2. Acrylic glass block vials
3. On/off switch
4. Laser battery compartment
5. Magnetic adapter for installing an angle prism or beam splitter
6. Laser warning label
7. Gradient module
8. Gradient module battery compartment

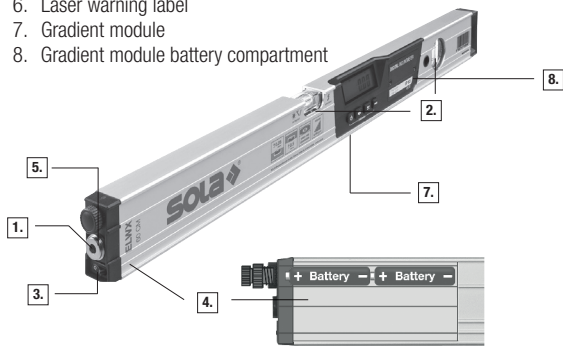

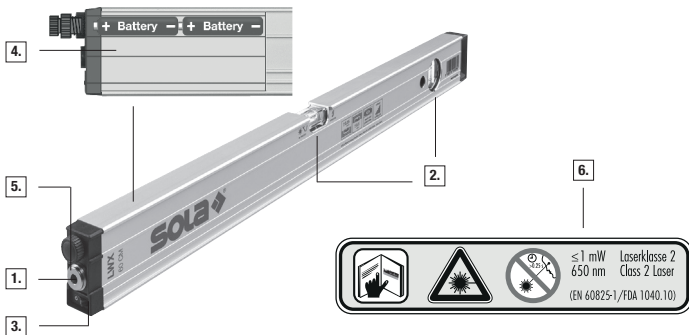

### 2.1.3 Gradient module

1. On/off switch / Display light
2. On/off switch acoustics (signal at 0° and 90°)
3. Hold function (measurement is retained by pressing once) / Toggling between ABS (absolute) and INC (incremental)
4. Mode button for switching between measured value settings (°, mm/m, %, in/ft)
5. Arrows show in which direction the spirit level has to be moved
6. Display ° / mm/m / % / in/ft
7. Display in the case of low battery voltage
8. Display of ABS or INC

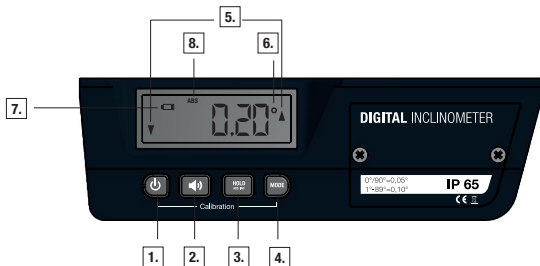

### 3. Technical data

#### 3.1 Gradient module

Max. measurement tolerance	
- 0° / 90°	± 0.05°
- 1° - 89°	± 0.10°
Protection class	IP 65
Power supply	3 x 1.5 V AAA batteries
Battery life (at 20°C)	30 hrs (if display light switched off, approx. 80 hrs)
Permissible temperatures	
Operating temperature	-10°C to +50°C
Storage temperature	-20°C to +70°C

#### 3.2 Laser

Working range	
- Laser point	$r = 30 \text{ m}^*$
Max. measurement tolerance	
- Laser beam to measuring surface	± 0.5 mm/m
- Laser beam to lateral surface	± 1.0 mm/m
Point size	
- At 10 m	approx. 6 mm
- At 20 m	approx. 10 mm
Power supply	2 x 1.5 V AAA batteries
Battery life (at 20°C)	
- AAA batteries	500 hrs
Permissible temperatures	
Operating temperature	-15°C to +50°C
Storage temperature	-20°C to +50°C
Laser diode lines/points	635–650 nm < 1 mW
Laser class 2	2, DIN EN 60825-1 and FDA 1040.10

\*... depending on the ambient conditions in the workplace. Subject to modifications (drafts, descriptions and technical data)

## 4. Safety instructions

---

### 4.1 AREA OF RESPONSIBILITY

---

#### 4.1.1 Manufacturer

SOLA is responsible for the safe delivery condition of the product, including the operating manual and the original accessories.

#### 4.1.2 Operator

The operator is responsible for using the product as intended, the deployment of personnel, their training and the operational safety of the product.

- The operator understands the safety information which is stated on the product and the instructions which are contained in the operating manual.
- The operator shall comply with local regulations relating to safety and accident prevention regulations as well as worker protection laws and regulations.
- The operator shall immediately notify SOLA if safety-related issues should develop on the product or during its utilization.
- The operator shall ensure that the product is not utilized any further if defects become evident, and will have the product repaired professionally.



#### 4.2 Improper Use

---

- Use of the device and the accessories without instruction.
- Use of third-party accessories or additional equipment.
- Use outside of the intended limits (see Chapter 3/Technical data).
- Use under extreme temperature fluctuations without an adequate acclimatization.
- Disabling of safety devices and removal of hazard notices and labels.
- Unauthorized opening of the device.
- Performance of modifications or alterations the device or the accessories.
- Deliberate blinding of third parties.
- Inadequate safeguarding at the installation site.

#### 4.3 Utilization limitations

---

The ENW, ENWM, LASERTRONIC ELWX, PROFILINE LWX is suitable for a continuous use in an atmosphere which can be inhabited by humans.

- Do not operate the product in explosion-prone or corrosive environments.
- Inform the local safety authorities and safety experts before working in hazardous environments, in close proximity to electrical installations or similar surroundings.



## 4.4 Usage Hazards

### 4.4.1 General



#### WARNING

Missing or incomplete instructions may result in improper or incorrect use. This can cause accidents with serious damages to persons, property, assets and the environment.

- Follow the manufacturer's and operator's safety instructions.
- Protect equipment and accessories from access by children.



#### WARNING

Blinding by laser radiation can indirectly lead to serious accidents, especially for people who are driving a vehicle or operating machinery. Do not look into the laser beam.

- Do not set up the laser beam and the laser plane at eye level or aim at people.



#### CAUTION

A fall, longer storage, transportation or other mechanical effects can lead to erroneous measurement results. Check the unit for damage before use. Do not use damaged equipment.

- Repairs have to be exclusively performed by SOLA
- Before use, check the accuracy of the device (see Chapter 8/Checking the accuracy)

### 4.4.2 Charger/batteries/rechargeable batteries



#### DANGER

Mechanical damage can lead to a leakage, fire or explosion of the batteries or trigger the release of toxic substances.

- Batteries and rechargeable batteries may not be opened or exposed to mechanical loads.
- Damaged batteries, chargers and charging stations may not be used.
- Repairs have to be exclusively performed by SOLA.



#### WARNING

High ambient temperatures and immersion into liquids can cause a leakage, fire or explosion of the batteries or trigger the release of toxic substances.

- Protect batteries and rechargeable batteries from mechanical damage during transport.
- Never store the Li-Ion battery in the sun, on radiators or behind glass windows.
- Do not overheat batteries and rechargeable batteries or expose them to fire.
- Avoid the ingress of moisture into batteries and rechargeable batteries.
- Do not use damaged batteries or rechargeable batteries. Dispose of properly.(see Chapter 12/Disposal).

**WARNING**

A short-circuiting or unintended use can cause batteries to overheat and create an injury or fire hazard.

- Do not transport or store batteries in the pockets of garments.
- Do not bring the battery contacts in contact with jewelry, keys, or other electrically conductive objects.
- Do not charge non-rechargeable batteries
- Do not discharge the batteries through short-circuiting.
- Do not solder the batteries within the device.
- Do not mix old and new batteries, and do not mix batteries from different manufacturers or with a differing type designation.

**WARNING**

Using charging devices from other manufacturer's can damage the Li-Ion batteries. This can lead to a fire and explosion hazard.

- Only use original SOLA accessories.

**WARNING**

If disposed of improperly third parties can possibly be seriously injured and the environment polluted. The burning of plastic components generates toxic fumes which may impair the health of people. Batteries/rechargeable batteries may explode if they are damaged or heated excessively, and thereby cause poisoning, burning, corrosion or environmental contamination. If disposed of negligently unauthorized persons are able to use the product improperly.

- The product must not be disposed of together with household waste. Dispose of the device and accessories properly (see Chapter 12/Disposal).
- Protect the product at all times from access by unauthorized persons, and especially children.

## **4.5 ELECTROMAGNETIC COMPATIBILITY (EMC)**

---

The electromagnetic compatibility is the ability of the product to function in an environment where electromagnetic radiation and electrostatic discharge are present, without causing electromagnetic interference to other devices.

### **4.5.1 Interference of other devices by ENW, ENWM, LASERTRONIC ELWX, PROFILINE LWX**

Although the product meets the strict requirements of the relevant directives and standards, SOLA can not completely exclude the possibility of interference with other devices (for example, when using the product in combination with third-party devices, such as field computers, personal computers, wireless devices, mobile phones, certain cables or external batteries).

- When using computers and radio equipment make sure to observe the vendor-specific information about electromagnetic compatibility.
- Only use original SOLA equipment and accessories.

### **4.5.2 Interference of the ENW, ENWM, LASERTRONIC ELWX, PROFILINE LWX by other devices**

Although the product meets the strict requirements of the relevant directives and standards, SOLA can not entirely exclude the possibility that intense electromagnetic radiation in the immediate vicinity of radio transmitters, two-way radios, diesel generators, etc. can distort the measurement results.

- When performing measurements under these conditions check the plausibility of the results.

## 5. LASER SAFETY/CLASSIFICATION

LASERTRONIC ELWX and PROFILINE LWX emit a visible laser point.  
The product complies with laser class 2, DIN EN 60825-1 and FDA 1040.10.

### Laser class 2:

With class 2 laser devices, eyes are protected by the blink reflex and/or the aversion responses in the event that a person accidentally looks at the laser for a short time.



#### WARNING

Looking directly into the laser beam with optical aids (such as binoculars, telescopes) can be dangerous.



#### CAUTION

Looking directly into the laser beam can damage the eyes.

- Do not look into the laser beam.
- Do not point the laser beam at other people.

### Labelling on the device:



- Do not remove labelling!

## 6. Start-up

---

Prior to initial set-up, check whether the batteries have been installed correctly in the device. Do not point the laser at people when you switch the device on.

### Inserting batteries

1. Open the battery compartment cover with an appropriate screwdriver.
2. Insert batteries making sure that the poles of the batteries are in the right position.
3. Close the battery compartment cover with an appropriate screwdriver.

Only use type 1.5 V AAA batteries!

If the device is not used for a long period of time, remove the batteries.



#### **NOTE**

The intensity of the laser lines can vary depending on the battery quality.

## 7. Operation

---

### 7.1. Switching on/off

---

➤ **On:**

Press the “On/off switch / Display light” to switch on the gradient module.

➤ **Off:**

Press the “On/off switch / Display light” for at least 2 seconds to switch off the gradient module.

### 7.2 Display

---

If the gradient spirit level is used in the inverted position (upside down – above your head), the display screen turns too so that the measurement can be read easily.

The display switches off automatically after 5 minutes, as soon as the device is no longer being moved.

### 7.3 Display light

---

1. Switch on the gradient module (display light is active)
2. Press the “On/off switch / Display light” to switch the light on and off.

### 7.4 Acoustic signal

---

The acoustic signalling is switched on by pressing the “On/off switch for acoustics”. The closer the gradient spirit level gets to the standard position, the more rapid the frequency of the acoustic signal.

This function assists you with levelling work, where it is not possible for you to read the measurement from the display.

### 7.5 Hold function

---

The current measurement is frozen by pressing the “Hold function” once.

A previously measured value can be “frozen” on the display using this function. The measurement remains unchanged until the “Hold function” button is pressed again.

### 7.6 Toggling between ABS and INC

---

You can toggle between ABS (absolute) and INC (incremental) by pressing the “Hold function” for more than 2 seconds.

In “ABS” (absolute) mode, the measurement result is displayed based on the device calibration. In contrast, in “INC” (incremental) mode, the measurement result is displayed based on a relative reference level.

For example, you can take a measurement on a 5° inclined plane in “ABS” mode and then toggle to

“INC” function. In doing so, the measurement display is set to 0°. You can now take additional measurements based on this new zero value. To leave “INC” mode, press the button again for 2 seconds.

### **7.7 Changing measurement display**





---

➤ Press the “Display switch” to change between ° / mm/m / % / in/ft.

## 8. Calibration and adjustment



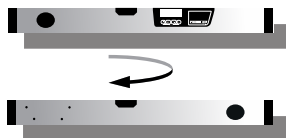

### 8.1 Calibration of gradient module

Calibration stage ① based on position 0°

- Place the ENW with the measurement surface horizontally
- Press the  and  buttons briefly
- Display -1- appears on the screen
- Press the  button briefly, display -1- flashes for approx. 5 seconds
- Display -2- appears on the screen
- Turn ENW by 180°
- Press the  button briefly, display -2- flashes for approx. 5 seconds
- Measurement display appears on the screen, calibration stage 1 is complete.



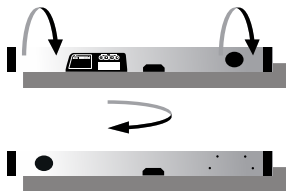

Calibration stage ② based on position 180°

- Turn ENW „upside down“ and place horizontally
- Press the  and  buttons briefly
- Display -1- appears on the screen
- Press the  button briefly, display -1- flashes for approx. 5 seconds
- Display -2- appears on the screen
- Turn ENW again by 180°
- Press the  button briefly, display -2- flashes for approx. 5 seconds
- Measurement display appears on the screen, calibration stage 2 is complete.



Calibration stage ③ based on position 90°

- Place the ENW with the measurement surface vertically
- Press the  and  buttons briefly
- Display -1- appears on the screen
- Press the  button briefly, display -1- flashes for approx. 5 seconds
- Display -2- appears on the screen

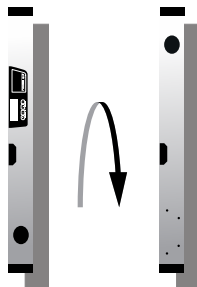



- Turn ENW by 180°
- Press the  button briefly, display -2- flashes for approx. 5 seconds
- Measurement display appears on the screen.
- The ENW is therefore fully calibrated.

## 8.2 Adjusting the laser spirit level on the levelling base

---

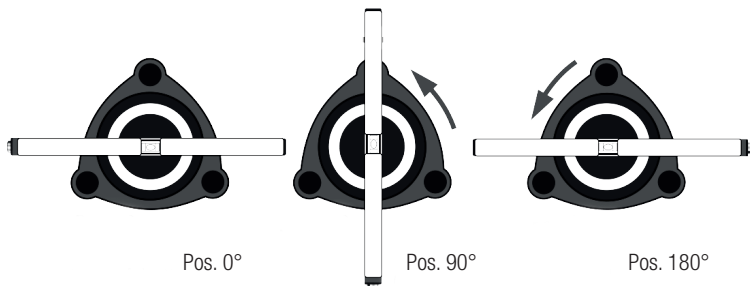

Place the device on the levelling base so that the product logo is in front of you (Pos. 0).

- 1) Adjust vial to a 0° position
- 2) Adjust vial to a 90° position
- 3) Adjust vial to a 180° position



### **WARNING:**

Always work with both screws when adjusting!

Making slight corrections after every turn mean no errors occur. These are sometimes necessary and therefore state of the art.

## 9. Maintenance, storage and transportation

---

### 9.1 Cleaning

---

- Wipe off any dirt with a soft damp cloth.
- Check the outlet windows of the laser regularly, and thoroughly clean them if necessary. Do not touch the glass with your fingers.
- Do not use aggressive cleaning agents or solvents.
- Do not immerse the device into water!
- Clean and dry wet equipment, accessories and transport containers prior to packaging them. Only pack equipment again when it is completely dry.
- Keep plug connections clean and protected from moisture.

### 9.2 Storage

---

#### 9.2.1 General

- The equipment may only be stored within the specified temperature limits (see Chapter 3/Technical data).
- After a prolonged storage, check the accuracy of the measuring device before using it.

#### 9.2.2 Batteries/rechargeable batteries

- For storage, remove the batteries from the device or from the charging station.
- The storage should preferably be performed in a dry environment at room temperature (see Chapter 3/Technical data).
- Protect from moisture and humidity. Dry wet or damp batteries before storage or before use.
- Prior to a prolonged storage, charge the battery to 80 % capacity (see Chapter 7/operation). Repeat the procedure every 6 months.
- After storage, fully charge the battery before use.
- Check the battery for damage before use. Do not use damaged batteries!

### 9.3 Transport

---

#### 9.3.1 General

The device may be damaged by strong vibrations or by dropping.

- Never transport the product loose. Always use the original packaging or an equivalent transport container.
- Switch off the measuring device before transporting it.
- Check the unit for damage before use.

### **9.3.2 Batteries/rechargeable batteries**

When transporting or shipping batteries, the operator is responsible for complying with the applicable national and international laws and regulations.

- Before shipping, remove the batteries from the device.

## 10. Scope of delivery and accessories

---

### 10.1 Scope of delivery for ENW, ENWM, LASERTRONIC ELWX, PROFILINE LWX:

---

ENW, ENWM, LASERTRONIC ELWX, PROFILINE LWX

AAA batteries

Quick Starter

### 10.2 ACCESSORIES (optional)

---

Angle prism **WP**

Beam splitter **ST**

Target **ZS RED**

Laser goggles **LB RED**

Levelling base **NB**

Telescopic tripod **TST**

Elevator tripod **KST**

Construction tripod **BST**

Transport bag

Further information regarding the accessories can be found at [www.sola.at](http://www.sola.at)

## 11. Troubleshooting

---

<b>Errors</b>	<b>Possible cause</b>	<b>Rectification</b>
Device is switched on, no display, screen not illuminated	<ul style="list-style-type: none"> <li>➤ Battery flat</li> <li>➤ Battery inserted incorrectly</li> <li>➤ Device or switch faulty</li> </ul>	<ul style="list-style-type: none"> <li>➤ Replace battery</li> <li>➤ Insert battery correctly</li> <li>➤ Contact dealer and have device repaired</li> </ul>
No laser beam function.	<ul style="list-style-type: none"> <li>➤ Battery empty</li> </ul>	<ul style="list-style-type: none"> <li>➤ Change the batteries</li> </ul>
Display jumps or screen "frozen"	<ul style="list-style-type: none"> <li>➤ Program error</li> </ul>	<ul style="list-style-type: none"> <li>➤ Remove batteries, wait one minute, reinsert batteries.</li> </ul>
Irregular display screen	<ul style="list-style-type: none"> <li>➤ Battery power low</li> </ul>	<ul style="list-style-type: none"> <li>➤ Change the batteries</li> </ul>
The device turns itself off immediately after start-up	<ul style="list-style-type: none"> <li>➤ Battery flat</li> </ul>	<ul style="list-style-type: none"> <li>➤ Change the batteries</li> </ul>
The device is switched on, the display is lit up but a laser beam is not visible	<ul style="list-style-type: none"> <li>➤ Ambient temperature too high/low</li> <li>➤ Laser diodes or laser control faulty</li> </ul>	<ul style="list-style-type: none"> <li>➤ Allow device to acclimatise</li> <li>➤ Contact your dealer and arrange for the device to be repaired</li> </ul>

## 12. Disposal

---

If disposed of improperly third parties can possibly be seriously injured and the environment polluted.

The burning of plastic components generates toxic fumes which may impair the health of people.

Batteries/rechargeable batteries may explode if they are damaged or heated excessively, and thereby cause poisoning, burning, corrosion or environmental contamination.

If disposed of negligently unauthorized persons may be able to use the product improperly.

Measuring tools, accessories and packaging must be recycled in an environmentally-friendly manner.



The product as well as the accessories - especially the batteries and rechargeable batteries - must not be disposed of with household waste.

- Dispose of the device and the accessories properly
- Only dispose of batteries in a discharged state.
- Observe the country-specific disposal requirements.

Your SOLA dealership will take back batteries as well as old equipment, and will ensure proper disposal.

### Only for EU countries



Electric tools must not be disposed of with household waste!

According to the European Directive 2002/96/EC on Waste Electrical and Electronic Equipment and its implementation in national law, no longer usable electrical and electronic equipment must be collected separately and recycled in an environmentally friendly manner.

## 13. Manufacturer's Guarantee

---

The manufacturer warrants to the original purchaser stated on the guarantee card, freedom from defects of the device for a period of two years, with the exception of batteries, as of the point in time the device is handed over. The guarantee is limited to repairs and/or replacements at the manufacturer's discretion. Defects which are caused through improper handling by the purchaser or third parties, natural wear and optical flaws that do not affect the usability of the equipment, are not covered by this guarantee. Claims under this guarantee can only be invoked if the device is submitted along with the guarantee card, completely filled out by the dealer, dated and provided with the company stamp. If the guarantee claim is justified, the manufacturer shall bear the transport costs. The duration of the guarantee will not be extended through repair or spare parts work which is carried out within the scope of the guarantee. Further claims are excluded, unless these are stipulated by the respective by the respective national legislation. In particular the manufacturer shall not be liable for any direct, indirect, incidental or consequential damages, losses or expenses in connection with the use or because of the inability to use the tool for any purpose whatsoever. Implied warranties for the usage or suitability for a particular purpose are expressly excluded.

## 14. EC conformity declaration



### Konformitätserklärung Declaration of Conformity Déclaration de Conformité



Wir / We / Nous **SOLA-Messwerkzeuge GmbH, A-6840 Götzis, Austria**  
erklären in alleiniger Verantwortung, dass das (die) Produkt(e)  
declare under our sole responsibility that the Product(s)  
déclarons sous notre seule responsabilité que le produit(s)

#### **ENW, ENWM, LASERTRONIC ELWX, PROFILINE LWX**

Auf das sich diese Erklärung bezieht, mit den folgenden Normen übereinstimmt.  
To which this declarations relates is in conformity with the following standards.  
Auquel se réfère cette déclaration est conforme aux normes.

#### **Gradient module:**

- EN61326-1:2013
- EN55011:2009+A1:2010
- EN61000-4 2:2009
- EN61000-4-3:2006+A1:2008+A2:2010

#### **Laser:**

- EN 61000-6-1: 2007
- EN 61000-6-3: 2007 + A1:2011
- UN38.3

Gemäss den Bestimmungen der Richtlinie(n)  
Following the provisions of Directive(s)  
Conformément aux dispositions de Directive(s)

#### **Electromagnetic compatibility 2014/30/EU Low Voltage Directive 2014/35/EU**

SOLA-Messwerkzeuge GmbH

Mag. Wolfgang Scheyer CEO



**Herstellergarantie ENW, ENWM,  
LASERTRONIC, PROFILINE**

Limited warranty/ENW, ENWM, LASERTRONIC/ELVX,  
PROFILINE/LVX

\_\_\_\_\_  
Seriennummer / Serial no.

\_\_\_\_\_  
Firma / Company / Name

\_\_\_\_\_  
Adresse / address

\_\_\_\_\_  
Telefon / Telephone



**SOLA-Messwerkzeuge GmbH**

Unteres Tobel 25  
A-6840 Götzis  
Austria



\_\_\_\_\_  
Kaufdatum/Stempel/Unterschrift des Händlers    Date of purchase/Stamp/Signature (dealer)

