

RS PRO PNEUMATICS

Range Overview



rspro.com



CONTENTS



FITTINGS

VALVES

ACTUATORS

AIR TREATMENT

TUBING

Push-in Fittings	4
Technopolymer Push-in Fittings	7
Acetal Push-In Fittings	19
Stainless Steel Push-In Fittings	25
Stainless Steel Threaded Adaptors	28
Push-On Fittings	31
Function Fittings	36
Quick Couplings	40
Blow Guns	57
Nickel-Plated Brass Adaptors	58

Ball Valves	70
Solenoid Pilot Valves	71
Fluid Solenoid Valves	74

Magnetic Switches	77
Compact Cylinders	78
Mini Cylinders	82
Accessories for Cylinders	83

Air Treatment Units	86
Pressure and Vacuum Gauges	89

Tubing	90
--------	----

**EXPLORE OUR
RANGE OF OVER
60,000 PRODUCTS**

**RS PRO is the own brand of RS and Allied that
gives you every part you need across all
industries at the quality and price you expect.**

rspro.com



Push-In Fittings

Designed for arduous applications in packaging, automotive and production environments, RS PRO push-in fittings contain a range of nickel plated brass connectors. Quick connection/disconnection and metal robustness help make this range the icon of quality, reliability and endurance in the pneumatic field.

Features

Main advantages

- Quick connection and disconnection
- Full flow and vacuum resistance thanks to shaped seals
- 3 threads available: BSPP, BSPT (universal short) & metric
- Lighter and more compact
- Specific configurations to satisfy advanced robotics applications
- Silicon free

Applications

- Robotics
- Automotive
- Textile, packaging, handling
- Compressed air circuits
- Industrial water
- Vacuum

STRAIGHT MALE ADAPTOR (PARALLEL)

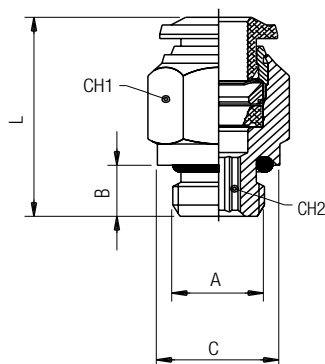

Stock No.	Tube	A	B	C	L	CH1	CH2	Pack
176-1276	4	1/8	6	13	20	10	3	10
176-1283	4	1/4	8	16	19.5	16	3	10
176-1275	4	M5	4	8	21	10	2	10
176-1277	6	1/8	6	13	23.5	13	4	10
176-1278	6	1/4	8	16	23.5	13	4	10
176-1284	6	3/8	9	20	25	13	4	10
176-1285	6	1/2	10	25	27	13	4	10
176-1282	6	M5	4	10	24.5	13	2	10
176-1279	8	1/8	6	13	25	14	5	10
176-1280	8	1/4	8	16	23	14	6	10
176-1281	8	3/8	9	20	24	14	6	10
176-1286	8	1/2	10	25	26.5	14	6	10
176-1764	8	M12x1.5	8	15	27.5	14	6	10
176-1761	10	1/4	8	16	30.5	17	6	10
176-1762	10	3/8	9	20	27.5	17	8	10
176-1768	10	1/2	10	25	27	17	8	10
176-1769	12	1/4	8	16	34.5	20	6	10
176-1763	12	3/8	9	20	34	20	8	10
176-1765	12	1/2	10	25	31	22	10	10
176-1766	14	3/8	9	20	35	21	10	10
176-1767	14	1/2	10	25	32	22	11	10

STRAIGHT FEMALE ADAPTOR

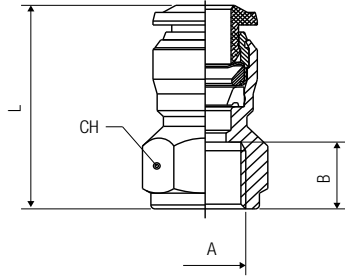

Stock No.	Tube	A	B	L	CH	Pack
176-1287	4	1/8	8.5	24	13	10
176-1294	4	1/4	11	27.5	16	10
176-1293	4	M5	5.5	21	11	10
176-1288	6	1/8	8.5	26	13	10
176-1290	6	1/4	11	29.5	16	10
176-1291	8	1/8	8.5	27	15	10
176-1292	8	1/4	11	29.5	17	10
176-1295	8	3/8	12	32	19	10
176-1770	10	1/4	11	32	18	10
176-1771	10	3/8	12	33.5	19	10
176-1772	10	1/2	15	39	24	10
176-1773	12	3/8	12	36	21	10
176-1774	12	1/2	15	41	24	10

MALE ADAPTOR PARALLEL

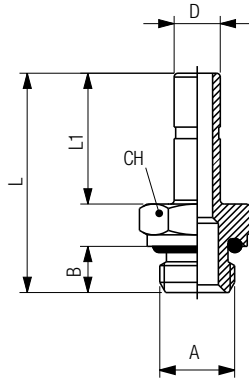

Stock No.	Tube	A	B	L	L1	CH	Pack
176-1300	4	1/8	6	26.5	15	13	10
176-1299	4	M5	4	24	15	8	10
176-1307	5	1/8	6	28.5	17	13	10
176-1308	5	1/4	8	31	17	16	10
176-1306	5	M5	4	26	17	8	10
176-1301	6	1/8	6	28.5	17	13	10
176-1309	6	M5	4	26	17	8	10
176-1303	8	1/8	6	29.5	18	13	10
176-1304	8	1/4	8	32	18	16	10
176-1305	8	3/8	9	33.5	18	20	10
176-1783	10	1/8	6	33.5	22	13	10
176-1779	10	1/4	8	36	22	16	10
176-1780	10	3/8	9	37.5	22	20	10
176-1781	12	1/4	8	38.5	24.5	16	10
176-1782	12	3/8	9	40	24.5	20	10
176-1784	14	1/2	10	44	26.5	24	10

POLYAMIDE PLUG

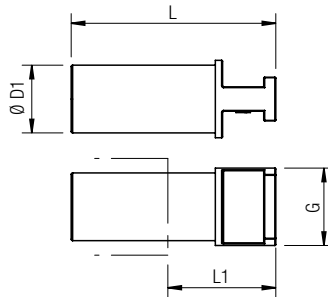

Stock No.	ØD1	G	L	L1	Pack
176-1310	4	6	29.5	15.5	10
176-1311	6	8	32	15.5	10
176-1312	8	10	35.5	19.5	10
176-1785	10	12	40	19.5	10
176-1786	12	14	41.5	20	10
176-1787	14	16	42	19.5	10

Technopolymer Push-In Fittings

The Technopolymer push-in range answers the most extreme demands of pneumatic automation. It offers a lighter and more compact plastic solution for customers requiring high performance.

A wide range of diameters is available, from 4 to 14mm.

Features

Main advantages

- Quick connection and disconnection
- Full flow and vacuum resistance thanks to shaped seals
- 3 threads available: BSPP, BSPT (universal short) & metric
- Lighter and more compact
- Specific configurations to satisfy advanced robotics applications
- Silicon free

Applications

- Robotics
- Automotive
- Textile, packaging, handling
- Compressed air circuits
- Industrial water
- Vacuum

STRAIGHT MALE ADAPTOR “UNIVERSAL SHORT”

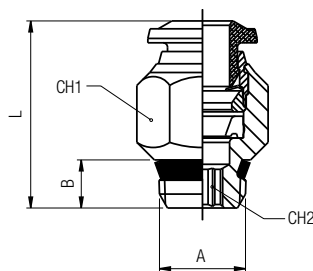

Stock No.	Tube	A	B	L	CH1	CH2	Pack
176-1313	4	1/8	5.5	18	11	3	10
176-1320	4	1/4	7	19	14	3	10
176-1314	6	1/8	5.5	21.5	13	4	10
176-1315	6	1/4	7	21	14	4	10
176-1321	6	3/8	7.5	23	17	4	10
176-1322	6	1/2	9	23.5	21	4	10
176-1316	8	1/8	5.5	24.5	14	5	10
176-1317	8	1/4	7	22	14	6	10
176-1319	8	3/8	7.5	23	17	6	10
176-1323	8	1/2	9	23.5	21	6	10
176-1788	10	1/4	7	28	17	7	10
176-1789	10	3/8	7.5	25.5	17	8	10
176-1792	10	1/2	9	26	21	8	10
176-1790	12	1/4	7	31.5	20	7	10
176-1791	12	3/8	7.5	29.5	20	9	10
176-1793	12	1/2	9	31.5	21	10	10
176-1794	14	3/8	7.5	32.5	21	9	10
176-1795	14	1/2	9	31.5	21	10	10

STRAIGHT FEMALE ADAPTOR

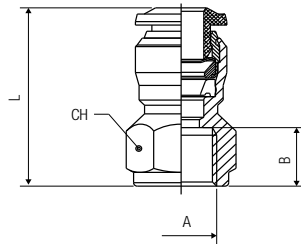

Stock No.	Tube	A	B	L	CH	Pack
176-1287	4	1/8	8.5	24	13	10
176-1294	4	1/4	11	27.5	16	10
176-1293	4	M5	5.5	21	11	10
176-1288	6	1/8	8.5	26	13	10
176-1290	6	1/4	11	29.5	16	10
176-1291	8	1/8	8.5	27	15	10
176-1292	8	1/4	11	29.5	17	10
176-1295	8	3/8	12	32	19	10
176-1770	10	1/4	11	32	18	10
176-1771	10	3/8	12	33.5	19	10
176-1772	10	1/2	15	39	24	10
176-1773	12	3/8	12	36	21	10
176-1774	12	1/2	15	41	24	10

STRAIGHT CONNECTOR

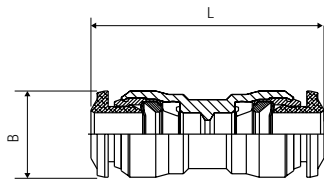

Stock No.	Tube	Tube	L	B	Pack
176-1325	4		31	10	10
176-1326	6		35	12,5	10
176-1328	6	4	34	12,5	10
176-1327	8		37	14	10
176-1331	8	4	37	14	10
176-1329	8	6	37	14	10
176-1796	10		45	17	10
176-1801	10	6	44	17	10
176-1799	10	8	44	17	10
176-1797	12		50	20	10
176-1802	12	8	50	20	10
176-1800	12	10	50	20	10
176-1798	14		48	21	10
176-1803	14	12	48	21	10

BULKHEAD CONNECTOR

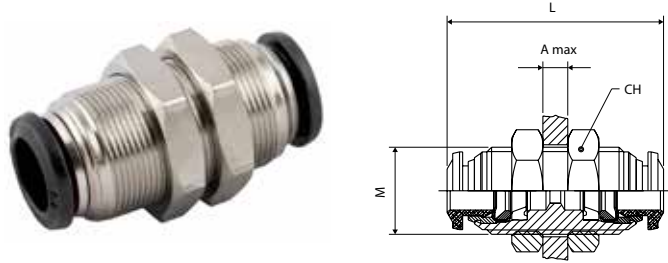

Stock No.	Tube	M	L	CH	A max	Pack
176-1296	4	M12×1	31.5	17	7	10
176-1297	6	M14×1	35	17	9.5	10
176-1298	8	M16×1	37	19	10.5	10
176-1775	10	M20×1	43	24	12.5	10
176-1776	12	M22×1	48	26	16.5	10
176-1777	14	M23×1	49	27	16.5	10

**ORIENTING ELBOW MALE ADAPTOR
“UNIVERSAL SHORT”**

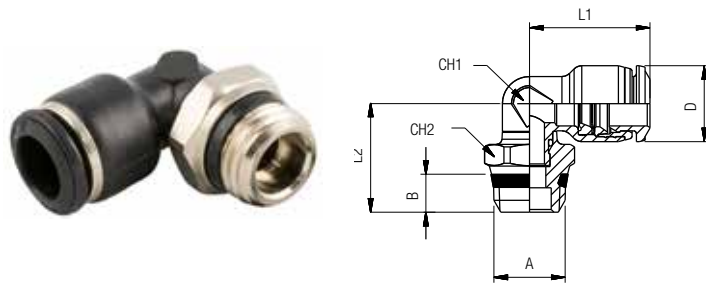

Stock No.	Tube	A	B	L1	L2	CH1	CH2	D	Pack
176-1332	4	1/8	5.5	16.5	16.5	7	13	10	10
176-1333	4	1/4	7	16.5	18	7	15	10	10
176-1334	6	1/8	5.5	20.5	17.5	9	13	12	10
176-1335	6	1/4	7	20.5	18.9	9	15	12	10
176-1336	6	3/8	7.5	20.5	20	9	17	12	10
176-1337	8	1/8	5.5	22	18.5	10	13	14	10
176-1338	8	1/4	7	22	20	10	15	14	10
176-1339	8	3/8	7.5	22	20.5	10	17	14	10
176-1804	10	1/4	7	26.5	21.8	13	16	17	10
176-1805	10	3/8	7.5	26.5	21.8	13	17	17	10
176-1806	10	1/2	9	26.5	24.3	13	21	17	10
176-1807	12	1/4	7	30	23.1	16	16	20	10
176-1808	12	3/8	7.5	30	23.1	16	17	20	10
176-1809	12	1/2	9	30	25.6	16	21	20	10
176-1810	14	3/8	7.5	31	26.5	18	20	21	10
176-1811	14	1/2	9	31	27	18	21	21	10

ORIENTING ELBOW MALE ADAPTOR (PARALLEL)

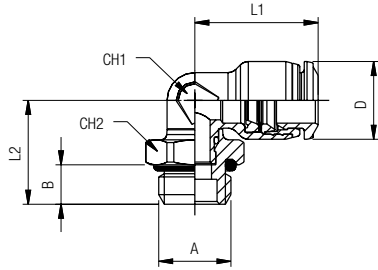

Stock No.	Tube	A	B	L1	L2	CH1	CH2	D	Pack
176-1342	4	1/8	5.4	16.5	15	7	13	10	10
176-1343	4	1/4	7.1	16.5	16.6	9	16	10	10
176-1340	4	M5	3.6	16.5	13.8	7	9	10	10
176-1341	4	M7×1	4.8	16.5	14.4	7	9	10	10
176-1345	6	1/8	5.4	20.5	15.8	9	13	12	10
176-1347	6	1/4	7.1	20.5	17.5	9	16	12	10
176-1348	6	3/8	8.1	20.5	19	9	20	12	10
176-1344	6	M5	3.6	20.5	14.7	9	9	12	10
176-1349	8	1/8	5.4	22	19.4	10	13	14	10
176-1350	8	1/4	7.1	22	18.7	10	16	14	10
176-1351	8	3/8	8.1	22	20.1	10	20	14	10
176-1812	10	1/4	7.1	26.5	22.8	13	16	17	10
176-1813	10	3/8	8.1	26.5	22.3	13	20	17	10
176-1814	10	1/2	9.6	26.5	23.8	13	25	17	10
176-1815	12	1/4	7.1	30	24.1	16	16	20	10
176-1816	12	3/8	8.1	30	23.6	16	20	20	10
176-1817	14	3/8	8.1	31	28.1	18	20	21	10
176-1818	14	1/2	9.6	31	26.1	18	25	21	10

ELBOW CONNECTOR

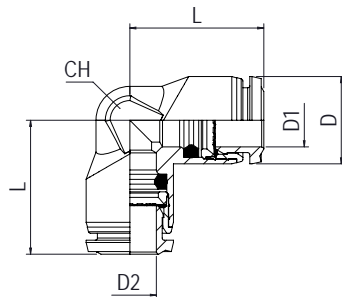

Stock No.	D1	D2	L	D	CH	Pack
176-1352	4	4	16.5	10	9	10
176-1353	6	6	20.5	12	11	10
176-1354	8	8	22	14	13	10
176-1819	10	10	26.5	17	16	10
176-1820	12	12	30	20	19	10

ORIENTING ELBOW

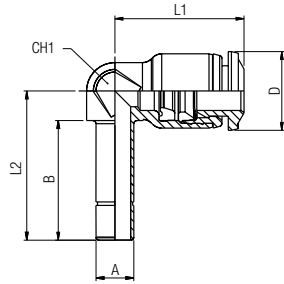

Stock No.	Tube	A	B	L1	L2	CH1	D	Pack
176-1355	4	4	17	16.5	20.8	7	10	10
176-1356	6	6	19	20.5	23.7	9	12.5	10
176-1357	8	8	20	22	26	10	14	10
176-1821	10	10	22.5	26.5	30	13	17	10

**ORIENTING TEE MALE ADAPTOR
"UNIVERSAL SHORT" - CENTRE LEG**

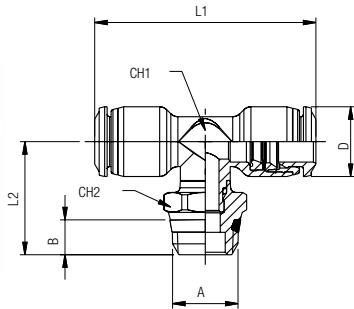

Stock No.	Tube	A	B	L1	L2	CH1	CH2	D	Pack
176-1358	6	1/8	5.5	41	20	9	13	12.5	10
176-1359	6	1/4	7	41	21.5	9	15	12.5	10
176-1360	8	1/8	5.5	44	21	10	13	14	10
176-1361	8	1/4	7	44	22.5	10	15	14	10
176-1362	8	3/8	7.5	44	23	10	17	14	10
176-1822	10	1/4	7	53	25.5	13	16	17	10
176-1823	10	3/8	7.5	53	25.5	13	17	17	10

**ORIENTING TEE MALE ADAPTOR
(PARALLEL) - CENTRE LEG**



Stock No.	Tube	A	B	L1	L2	CH1	CH2	D	Pack
176-1364	4	1/8	5.4	33	17.1	7	13	10	10
176-1365	4	1/4	7.1	33	18.8	7	16	10	10
176-1363	4	M5	3.6	33	15.5	7	9	10	10
176-1367	6	1/8	5.4	41	18.4	9	13	12.5	10
176-1369	6	1/4	7.1	41	20	9	16	12.5	10
176-1366	6	M5	3.6	41	14.7	9	9	12.5	10
176-1370	8	1/8	5.4	44	22.1	10	13	14	10
176-1371	8	1/4	7.1	44	21.4	10	16	14	10
176-1824	10	1/4	7.1	53	26.7	13	16	17	10
176-1825	10	3/8	8.1	53	26.2	13	20	17	10

TEE CONNECTOR



Stock No.	Tube	L1	L2	CH	D	D1	D2	Pack
176-1372	4	33	16.5	9	10	4	4	10
176-1373	6	41	20.5	11	12	6	6	10
176-1376	6-4-6	41	20	11	12,5	4	6	10
176-1375	8	44	22	13	14	8	8	10
176-1377	8-6-8	45	22,5	13	14	6	8	10
176-1826	10	53	26.5	16	17	10	10	10
176-1830	10-8-10	53	26	16	17	8	10	10
176-1827	12	61.5	30	19	20	12	12	10
176-1831	12-10-12	61,5	30	19	20	10	12	10
176-1828	14	61	30.5	20	21	14	14	10

Y CONNECTOR

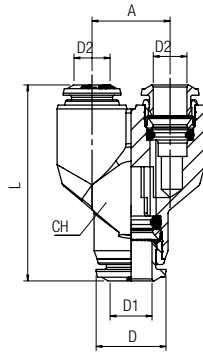

Stock No.	D1	D2	A	L	CH	D	Pack
176-1378	4	4	11	31.5	10	10	10
176-1381	6	4	13,5	36,5	12	12,5	10
176-1379	6	6	13,5	37	12	12	10
176-1382	8	6	15,5	41	14	14	10
176-1380	8	8	15,5	40	14	14	10
176-1834	10	8	19	47,5	17	18	10
176-1832	10	10	19	48,5	17	18	10
176-1833	12	12	22	57,5	20	20	10

PLUG-IN Y CONNECTOR

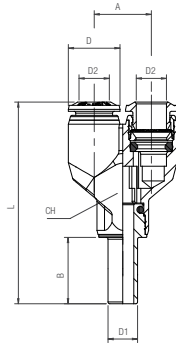

Stock No.	D1	D2	A	L	CH	D	B	Pack
176-1383	4	4	11	43	10	10	15	10
176-1386	6	4	13,5	49,5	12	12,5	17	10
176-1384	6	6	13,5	50	12	12,5	17	10
176-1387	8	6	15,5	55	14	12,5	18	10
176-1385	8	8	15,5	55	14	14	18	10
176-1388	10	8	19	65	17	17	22	10
176-1835	10	10	19	65,5	17	17	22	10
176-1836	12	12	22	78	20	20	24,5	10

REDUCTION MANIFOLD

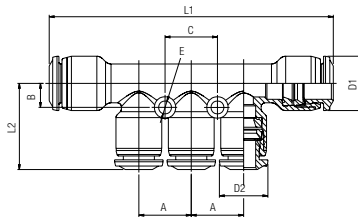

Stock No.	Tube	A	B	L1	L2	C	D1	D2	E	Pack
176-1837	6-4	13.5	6	74	22	13.5	14	12	3.3	10
176-1389	8-4	13.5	6	73	22	13.5	14	12	3.3	10
176-1838	8-6	13.5	6	73	22.5	13.5	14	12.5	3.3	10
176-1839	10-6	15	7	83	24	15	17	14	3.3	10
176-1840	10-8	15	7	83	23	15	17	14	3.3	10

SINGLE BANJO BODY

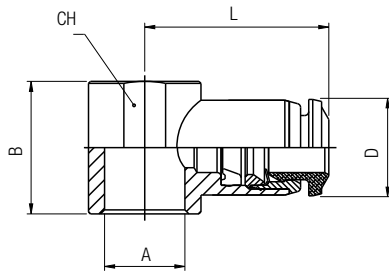

Stock No.	Tube	A	B	L	CH	D	Pack
176-1851	4	1/8	16.5	21.5	14	10	10
176-1849	4	M5	14	19.5	9	10	10
176-1850	4	M6	14	19.5	9	10	10
176-1854	5	1/8	16.5	22.5	14	12	10
176-1855	5	1/4	18.5	25	18	12	10
176-1852	5	M5	14	20.5	9	12	10
176-1853	5	M6	14	20.5	9	12	10
176-1858	6	1/8	16.5	23	14	12	10
176-1859	6	1/4	18.5	25.5	18	12	10
176-1856	6	M5	14	21	9	12	10
176-1857	6	M6	14	21	9	12	10
176-1860	8	1/8	16.5	23.5	14	14	10
176-1861	8	1/4	18.5	26	18	14	10
176-1862	8	3/8	22	27.5	21	14	10
176-1863	10	3/8	22	30.5	21	17	10
176-1864	12	3/8	22	32.5	21	20	10
176-1865	12	1/2	26	35	26	20	10

BANJO STEM SINGLE

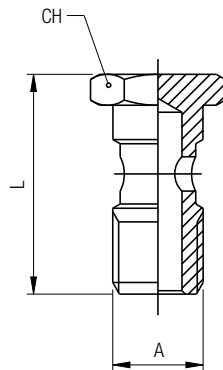

Stock No.	A	L	CH	Pack	L2
176-1842	1/8	28	14	10	22.5
176-1843	1/4	32	17	10	24
176-1844	3/8	36	19	10	23
176-1845	1/2	42	24	10	
176-1846	M5	22	8	10	22
176-1847	M6	23	8	10	22
176-1848	*M12×1.5	32	17	10	

MALE ADAPTOR PARALLEL

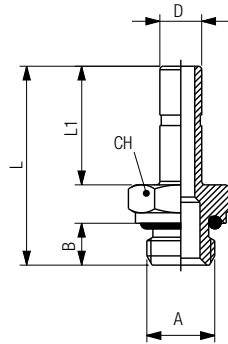

Stock No.	D	A	B	L	L1	CH	Pack
176-1300	4	1/8	6	26.5	15	13	10
176-1299	4	M5	4	24	15	8	10
176-1307	5	1/8	6	28.5	17	13	10
176-1308	5	1/4	8	31	17	16	10
176-1306	5	M5	4	26	17	8	10
176-1301	6	1/8	6	28.5	17	13	10
176-1309	6	M5	4	26	17	8	10
176-1303	8	1/8	6	29.5	18	13	10
176-1304	8	1/4	8	32	18	16	10
176-1305	8	3/8	9	33.5	18	20	10
176-1783	10	1/8	6	33.5	22	13	10
176-1779	10	1/4	8	36	22	16	10
176-1780	10	3/8	9	37.5	22	20	10
176-1781	12	1/4	8	38.5	24.5	16	10
176-1782	12	3/8	9	40	24.5	20	10
176-1784	14	1/2	10	44	26.5	24	10

POLYAMIDE PLUG

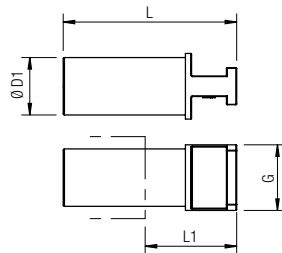

Stock No.	ØD1	G	L	L1	Pack
176-1310	4	6	29.5	15.5	10
176-1311	6	8	32	15.5	10
176-1312	8	10	35.5	19.5	10
176-1785	10	12	40	19.5	10
176-1786	12	14	41.5	20	10
176-1787	14	16	42	19.5	10

DOUBLE JOINT

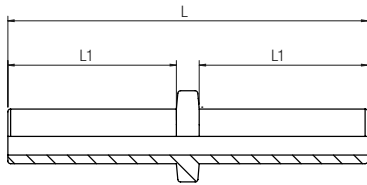

Stock No.	Tube	L	L1	Pack	L1
176-1390	4	34,5	16	10	15
176-1391	6	39,5	18,5	10	15
176-1392	8	42	19,5	10	17
176-1866	10	51,5	24	10	17
176-1867	12	60	28	10	17

REDUCER

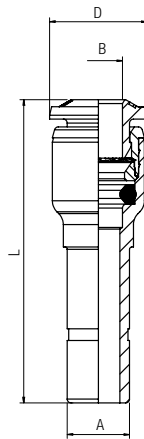

Stock No.	A	B	L	D	Pack
176-1393	6	4	34	10	10
176-1395	8	4	38,5	12	10
176-1394	8	6	39	12,5	10
176-1871	10	6	49,5	14	10
176-1868	10	8	42	14	10
176-1873	12	6	38,5	12,5	10
176-1869	12	8	41,5	14	10
176-1870	12	10	48,5	17	10
176-1874	14	8	37,5	14	10
176-1875	14	10	49,5	20	10
176-1872	14	12	50	20	10

MINI - STRAIGHT MALE ADAPTOR (PARALLEL)

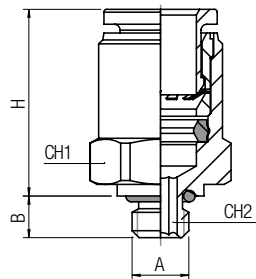

Stock No.	Tube	A	B	H	CH1	CH2	Pack
176-1397	3	M3	3	11	6	1,5	10
176-1398	3	M5	4	10	7	2	10
176-1399	4	M5	3,6	14	9	2,5	10
176-1400	4	1/8	5	11,5	13	3	10
176-1401	6	M5	3,6	16	11	2,5	10
176-1402	6	1/8	5	13,5	13	3	10
176-1404	6	1/4	7,1	12	16	4	10

MINI - STRAIGHT CONNECTOR

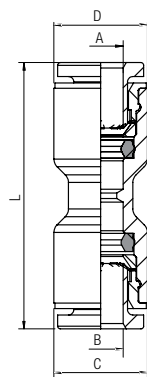

Stock No.	A	B	C	D	L	Pack
176-1405	4	4	8.5	8.5	25	10
176-1406	6	6	10.5	10.5	28	10
176-1407	8	6	10.5	14	34,5	10

MINI - BULKHEAD CONNECTOR

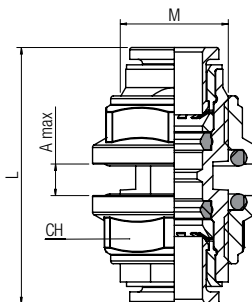

Stock No.	Tube	M	L	CH	A max	Pack
176-1408	4	M10×1	25	13	5,5	10
176-1409	6	M12×1	28	15	8,5	10

MINI - ORIENTING ELBOW MALE ADAPTOR (PARALLEL)

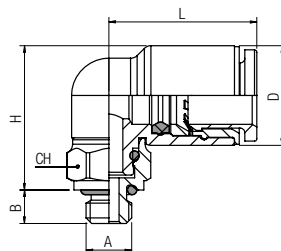

Stock No.	Tube	A	B	H	L	D	CH	Pack
176-1410	3	M3	3	13	11	6,5	8	10
176-1411	3	M5	4	12,5	11	6,5	8	10
176-1413	4	1/8	5	13	14	8,5	13	10
176-1414	4	1/4	7,1	13	14	8,5	16	10
176-1412	4	M5	3,6	13,5	14	8,5	8	10
176-1416	6	1/8	5	15	16	10,5	13	10
176-1417	6	1/4	7,1	15	16	10,5	16	10
176-1415	6	M5	3,6	15,5	16	10,5	8	10

MINI - EQUAL ELBOW

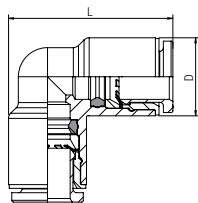

Stock No.	Tube	L	D	Pack
176-1418	4	19	8.5	10
176-1419	6	22.5	10.5	10

MINI - TEE CONNECTOR

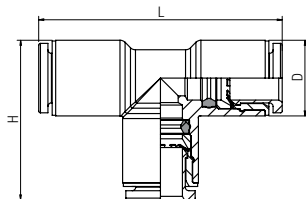

Stock No.	Tube	H	L	D	Pack
176-1420	3	14.5	22	6.5	10
176-1421	4	19	29	8.5	10
176-1422	6	22.5	34.5	10.5	10

MINI - ORIENTING FLOW REGULATOR FOR VALVE (PARALLEL)

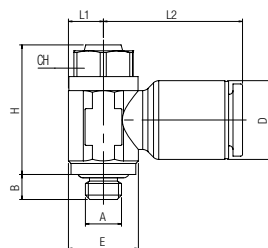

Stock No.	Tube	A	B	H	E	L1	L2	D	CH	Pack
176-1893	4	M5	3,6	18	9,5	4,5	16,5	8,5	8	10
176-1894	6	M5	3,6	18	9,5	4,5	19	10,5	8	10

MINI - ORIENTING FLOW REGULATOR FOR CYLINDER (PARALLEL)

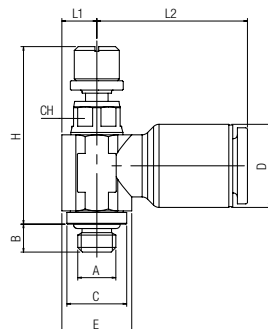

Stock No.	Tube	A	B	H	E	C	L1	L2	D	CH	Pack
176-1895	4	M5	3.6	21.5+24.5	9	7.5	4.5	17	8.5	6	10
176-1896	4	1/8	5	24+27.5	11.5	13.5	6.5	17	8.5	7	10
176-1897	6	M5	3.6	21.5+24.5	9	7.5	4.5	19.5	10.5	6	10
176-1898	6	1/8	5	24+27.5	11.5	13.5	6.5	19.5	10.5	7	10

Acetal Push-In Fittings

Designed for connection of tube-to-tube and tube to a threaded installation, our tube adaptors offer a flexibility you expect from RS PRO. All are push to connect, making connection fast and easy.

BULKHEAD ELBOW CONNECTOR



Stock No.	ØD	T	L	E	H1 (Hex)	H2 (Hex)
916-0839	4	M12×P1.0	33.5	23	14	14
916-0833	6	M14×P1.0	38	24	17	17
916-0842	8	M16×P1.0	43	29	19	19
916-0845	10	M20×P1.0	50	36	24	24

IN-LINE CONNECTOR

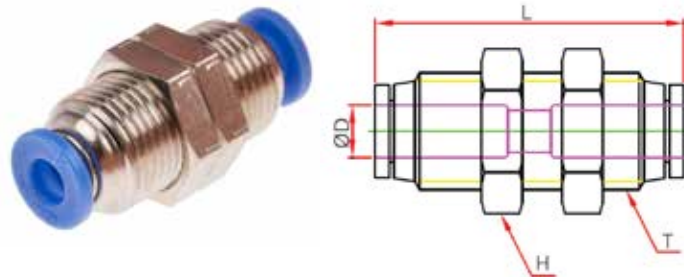

Stock No.	ØD	T	L	H (Hex)
916-0820	4	M12×P1.0	30.5	14
916-0823	6	M14×P1.0	31	17
916-0827	8	M16×P1.0	35	19
916-0836	10	M20×P1.0	41	24
144-2632	12	M22×P1.0	44	27

CROSS ADAPTOR

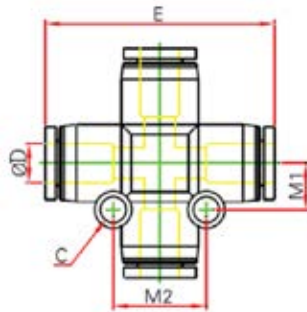

Stock No.	ØD	M1	M2	E	C
916-0928	6	7.9	15.8	38	3.2
916-0937	8	9	18	44.8	3.2
916-0930	10	11.8	23.5	56.8	4.2
144-2633	12	13.3	26.6	58.6	4.2

BANJO CONNECTOR

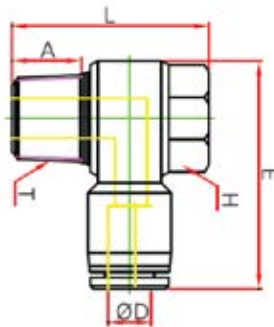

Stock No.	ØD	T	E	L	A	H (Hex)
916-0849	4	PT 1/8	29	23.6	7	12
144-2640	4	PT 1/4	34	26.5	8.5	14
144-2639	4	M5×P0.8	25	17.5	4	8
916-0858	6	PT 1/8	30	23	7	12
916-0851	6	PT 1/4	34	26.5	9.5	14
144-2641	6	M5×P0.8	26.5	17.5	4	8
916-0855	8	PT 1/8	32	24	7	12
916-0864	8	PT 1/4	37	26.5	9.5	14
916-0867	10	PT 1/8	37.5	24	7	12
916-0861	10	PT 1/4	41	26.5	9.5	14
144-2642	10	PT 3/8	43.2	32	10.5	19

ELBOW THREADED-TO-TUBE ADAPTOR



Stock No.	ØD	T (Thread)	E	L	A	H (Hex)
916-0754	4	M5×P0.8	24.5	37	3.5	8
916-0763	4	PT 1/8	29.5	41	7.5	12
916-0766	6	M5×P0.8	26.5	38.5	8	10
916-0760	6	PT 1/8	30	41	7.5	12
916-0779	6	PT 1/4	34	48.5	11.4	14
916-0772	8	PT 1/8	31.5	41	7.5	12
916-0776	8	PT 1/4	37.5	48.5	11.4	14
916-0785	10	PT 1/8	37	41	7.5	12
916-0788	10	PT 1/8	36	58.5	8	17
916-0782	10	PT 1/4	36	60.8	10	17

ELBOW TUBE-TO-TUBE ADAPTOR



Stock No.	ØD	E	M	C
916-0889	4	24	7	3.2
916-0883	6	25	8	3.2
916-0892	8	29	9	3.2
916-0895	10	37	12	4.2
144-2625	12	40	13.5	4.2

STRAIGHT NON RETURN VALVE



Stock No.	ØD	L
916-0934	4	44.5
916-0946	8	54
916-0943	6	47.5
916-0940	10	63.5
144-2702	12	65

SPEED CONTROL ELBOW

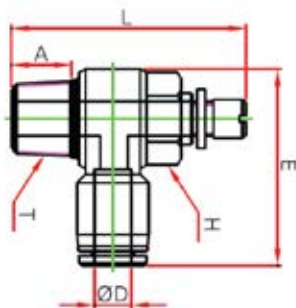

Stock No.	ØD	T	E	L Max	A	H (Hex)
144-2657	4	M5×P0.8	24.5	37	3.5	8
916-0959	4	PT 1/8	29.5	41	7.5	12
144-2658	6	M5×P0.8	26.5	38.5	8	10
916-0952	6	PT 1/8	30	41	7.5	12
144-2659	6	PT 1/4	34	48.5	11.4	14
916-0956	8	PT 1/8	31.5	41	7.5	12
144-2660	8	PT 1/4	37.5	48.5	11.4	14
916-0965	10	PT 1/8	37	41	7.5	12

MALE PUSH-IN THREADED-TO-TUBE ADAPTOR

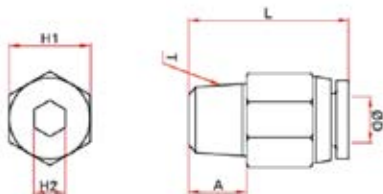

Stock No.	ØD	T (Thread)	L	A	H1 (Hex)	H2 (Hex)
916-0697	4	M5×P0.8	20	3.5	10	2
916-0707	4	PT 1/8	20.5	8	10	3
916-0700	4	PT 1/4	19	10	14	3
916-0704	6	M5×P0.8	21	3.5	12	2
916-0713	6	PT 1/8	21.3	8	12	4
916-0716	6	PT 1/4	23	10	14	4
916-0710	8	PT 1/8	26	8	14	5
916-0729	8	PT 1/4	25	10	14	5
144-2604	8	PT 3/8	22	11	17	5
916-0722	10	PT 1/8	30	8	17	5
916-0726	10	PT 1/4	31.5	10	17	6
144-2605	10	PT 3/8	29	11	17	8
144-2606	12	PT 3/8	30.6	11	21	8
144-2607	12	PT 1/2	31.6	14	21	8

FEMALE PUSH-IN THREADED-TO-TUBE ADAPTOR

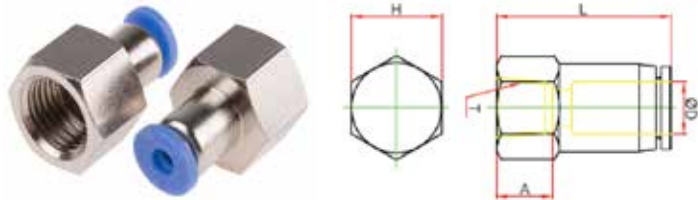

Stock No.	ØD	T	L	A	H (Hex)
916-0738	4	PT 1/4	26.5	10	17
916-0732	6	PT 1/8	25	8.5	14
916-0741	6	PT 1/4	27	10	17
916-0744	8	PT 1/8	26	8.5	14
916-0748	8	PT 1/4	28.5	10	17
916-0757	10	PT 1/8	30	8.5	17
916-0750	10	PT 1/4	32	11	17

STRAIGHT TUBE-TO-TUBE CONNECTOR

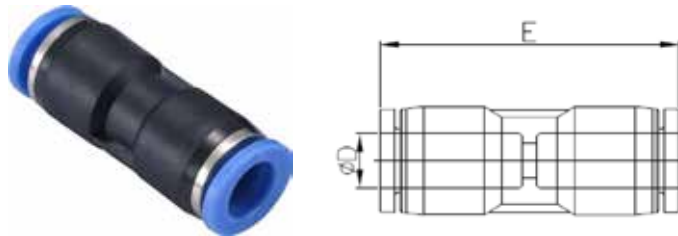

Stock No.	ØD	E
916-0870	4	33
916-0873	6	34.5
916-0877	8	38.5
916-0886	10	48.5
144-2624	12	49

PUSH-IN Y TUBE-TO-TUBE ADAPTER

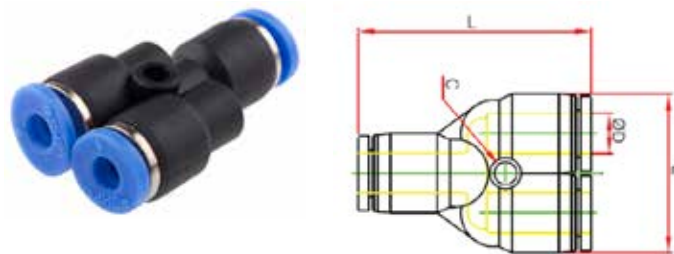

Stock No.	ØD	L	E	C
916-0915	4	35.5	22	3.2
916-0918	6	37	26	3.2
916-0912	8	39.5	30	3.2
916-0921	10	50.5	37	4.2
144-2627	12	52.5	42	4.2

PUSH-IN TEE THREADED-TO-TUBE ADAPTOR



Stock No.	ØD	T (Thread)	E	L	A	H (Hex)
916-0791	4	M5×P0.8	37	26.3	4	10
916-0794	4	PT 1/8	37	29.9	8	10
144-2619	4	PT 1/4	37	32	10	14
916-0798	6	M5×P0.8	38	28.4	4	12
916-0808	6	PT 1/8	38	31.5	8	12
916-0801	6	PT 1/4	38	34	10	14
916-0805	8	PT 1/8	44.5	35	8	14
916-0814	8	PT 1/4	44.5	37	10	14
144-2620	8	PT 3/8	44.5	38.6	11	17
916-0817	10	PT 1/8	56.5	42.2	8	17
916-0811	10	PT 1/4	56.5	44.5	10	17
144-2621	10	PT 3/8	56.5	45.5	11	17
144-2622	12	PT 3/8	58	48.3	11	19
144-2623	12	PT 1/2	58	50.5	14	21

PUSH-IN TEE TUBE-TO-TUBE ADAPTOR



Stock No.	ØD	E	L	M1	M2	C
916-0899	4	36.5	24	7	14	3.2
916-0909	6	37.5	25.5	8	16	3.2
916-0902	8	44.5	29.5	9	18	3.2
916-0906	10	57	37	12	24	4.2
144-2626	12	58	39	13.5	27	4.2

Stainless Steel Push-In Fittings

Fully made of stainless steel AISI 316L, the RS PRO stainless steel push-in range has been developed to drive corrosive fluids or to be used in aggressive environments. The range is ideal for direct contact with food fluids.

This line can be used also in salty environments and on machines that need frequent washing with aggressive detergents.

The series conforms to NSF 61, NSF 169 & NSF 372.

Features

Main advantages

- Quick connection and disconnection
- Full flow and vacuum resistance thanks to shaped seals
- 3 threads available: BSPP, BSPT (universal short) & metric
- Full stainless steel AISI 316L
- Food & beverage compatible
- Silicon free

Applications

- Automation with washing
- Farming, fining,
- Chemical, petro-chemical, pharmaceutical
- Medical, life & sciences
- Vacuum

STRAIGHT MALE ADAPTOR (TAPER)

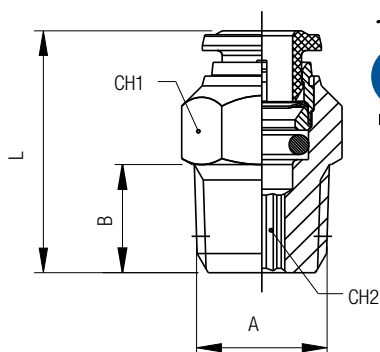

Stock No.	Tube	A	B	L	CH1	CH2	Pack
176-2151	6	1/8	7.5	22.5	13	4	10
176-2152	6	1/4	11	24.5	14	4	10
176-2154	8	1/8	7.5	25.5	14	5	10
176-2155	8	1/4	11	25	14	6	10
176-2156	10	1/4	11	30.5	17	7	10
176-2157	12	3/8	11.5	33.5	21	9	10

STRAIGHT MALE ADAPTOR (PARALLEL)

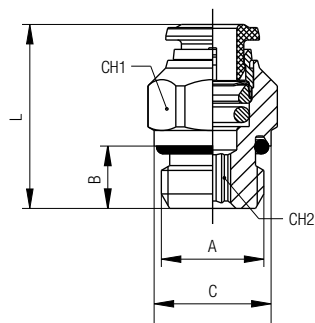

Stock No.	Tube	A	B	C	L	CH1	CH2	Pack
176-2158	4	1/8	6	13	19.5	10	3	10
176-2160	4	M5	4	8	20	10	2	10
176-2159	6	1/8	6	13	23.5	13	4	10

STRAIGHT CONNECTOR

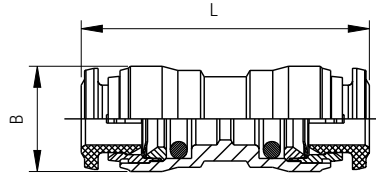

Stock No.	Tube	L	B	Pack
176-2161	4	31	10.5	10
176-2162	6	35	12.5	10
176-2163	8	36.5	14.5	10
176-2164	10	42	17.5	10

BULKHEAD CONNECTOR

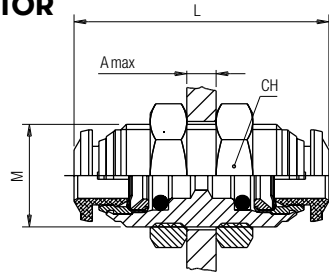

Stock No.	Tube	M	L	CH	A max	Pack
176-2165	4	M12×1	31	17	7	10
176-2166	6	M14×1	35	17	9.5	10
176-2167	8	M16×1	37	19	10.5	10

ORIENTING ELBOW MALE ADAPTOR (TAPER)

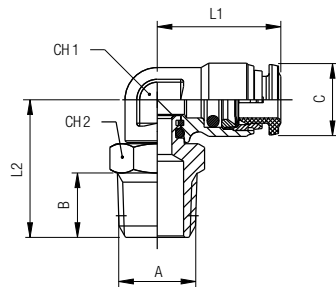

Stock No.	Tube	A	B	C	L1	L2	CH1	CH2	Pack
176-2168	6	1/4	11	12.5	21	26	11	14	10
176-2169	8	1/4	11	14.5	22.5	28.5	12	14	10

ORIENTING ELBOW MALE ADAPTOR (PARALLEL)

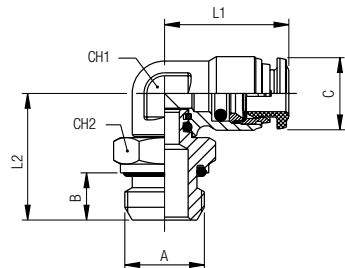

Stock No.	Tube	A	B	C	L1	L2	CH1	CH2	Pack
176-2170	4	M5	4	10	18	18.5	9	8	10

ELBOW CONNECTOR

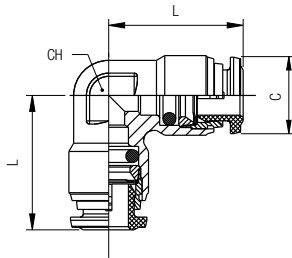

Stock No.	Tube	C	L	CH	Pack
176-2171	4	10	18	9	10
176-2172	6	12.5	21	11	10
176-2173	8	14.5	22.5	12	10

TEE CONNECTOR

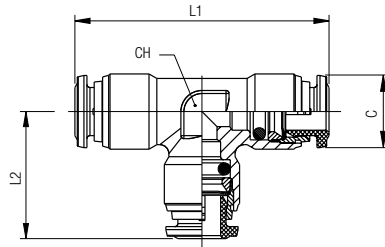

Stock No.	Tube	C	L1	L2	CH	Pack
176-2174	4	10	36	18	9	10
176-2176	6	12.5	42	21	11	10
176-2177	8	14.5	45	22.5	12	10

RUBBER HOISING IT MATTERS.

Explore the RS PRO range of rubber tubing and hosing for fluid, gases and solids.

rspro.com



Stainless Steel Threaded Adaptors

Fully made of stainless steel AISI 316L, the RS PRO threaded adaptor range has been developed to drive corrosive fluids or to be used in aggressive environments. It is ideal for direct contact with food fluids.

This line can be used in salty environments and on machines that need frequent washing with aggressive detergents.

The series conforms to NSF 61, NSF 169 & NSF 372.

Features

Main advantages

- Quick connection and disconnection
- Full flow and vacuum resistance thanks to shaped seals
- 3 threads available: BSPP, BSPT (universal short) & metric
- Full stainless steel AISI 316L
- Food & beverage compatible
- Silicon free

Applications

- Automation with washing
- Farming, mining
- Chemical, petrochemical, pharmaceutical
- Medical, life & sciences
- Vacuum

NIPPLE (TAPER)

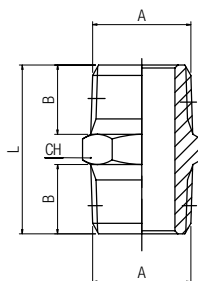

Stock No.	A	B	L	CH	Pack
176-2178	1/4	11	27	14	10
176-2179	3/8	11.5	28	17	10
176-2180	1/2	14	33.5	22	10
176-2182	3/4	16.5	40	27	10

REDUCING NIPPLE (TAPER)

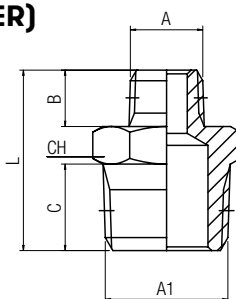

Stock No.	A	A1	B	C	L	CH	Pack
176-2186	1/8	1/4	7.5	11	23.5	14	10
176-2183	1/4	3/8	11	11.5	27.5	17	10
176-2184	3/8	1/2	11.5	14	31	22	10
176-2185	1/2	3/4	14	16.5	37.5	27	10

REDUCER (TAPER)

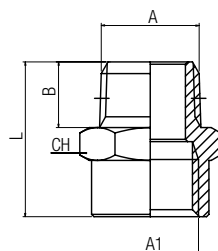

Stock No.	A	A1	B	L	CH	Pack
176-2187	1/4	1/2	11	30	24	10
176-2188	1/8	1/4	7.5	22	17	10

REDUCER (TAPER)

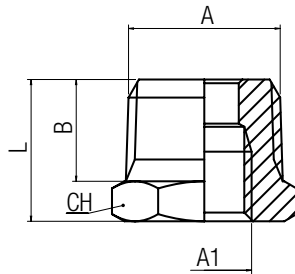

Stock No.	A	A1	B	L	CH	Pack
176-2189	1/4	1/8	11	16	14	10
176-2190	3/8	1/8	11.5	16.5	17	10
176-2191	3/8	1/4	11.5	16.5	17	10
176-2192	1/2	1/4	14	19.5	22	10
176-2193	1/2	3/8	14	19.5	22	10

SLEEVE

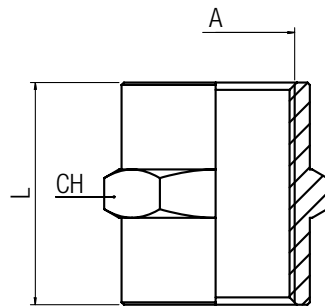

Stock No.	A	L	CH	Pack
176-2194	1/8	15	14	10
176-2195	1/4	22	17	10
176-2196	3/8	24	22	10
176-2197	1/2	30	27	10

MALE PLUG (TAPER) DIN 906

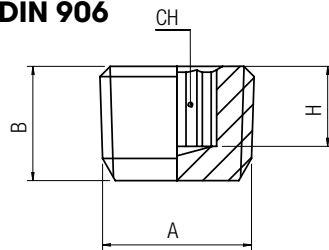

Stock No.	A	B	H	CH	Pack
176-2198	1/8	7.5	5	5	10
176-2199	1/4	10	7	6	10
176-2200	3/8	11	7	8	10
176-2201	1/2	13	8	10	10

MALE HOSE ADAPTER (TAPER)

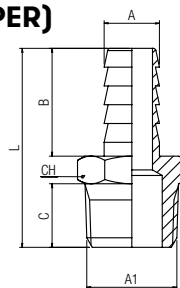

Stock No.	A	A1	B	C	L	CH	Pack
176-2202	7	1/4	19.5	11	35.5	14	10
176-2203	7	1/8	19.5	7.5	32	11	10
176-2204	10	1/4	19.5	11	35.5	14	10
176-2205	10	3/8	19.5	11.5	36	17	10
176-2206	16	1/2	19.5	14	39	22	10

FEMALE TEE

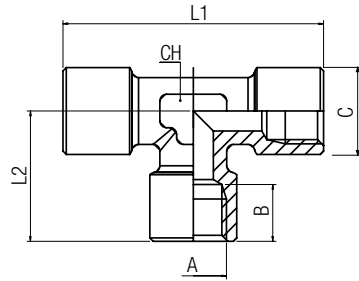

Stock No.	A	B	C	L1	L2	CH	Pack
176-2207	1/8	8.5	13	37	18.5	12	10
176-2208	1/4	11	16.5	49	24.5	12	10
176-2209	3/8	12	20.5	54	29	15	10
176-2211	1/2	15	25.5	64	34	20	10

FEMALE ELBOW

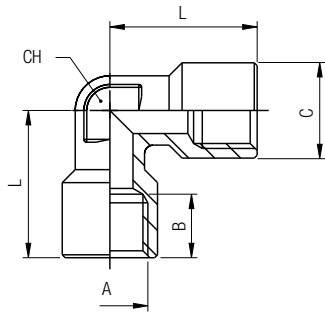

Stock No.	A	C	B	L	CH	Pack
176-2212	1/8	13	8.5	21	10	10
176-2213	1/4	16.5	11	25.5	12	10
176-2214	3/8	20.5	12	28	15	10
176-2215	1/2	25.5	15	32	20	10

MALE-FEMALE ELBOW

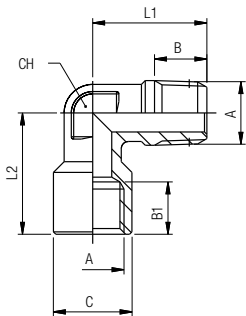

Stock No.	A	B	B1	C	L1	L2	CH	Pack
176-2216	1/8	7.5	8.5	13	18	21	10	10
176-2217	1/4	11	11	16.5	24	25.5	12	10
176-2218	3/8	11.5	12	20.5	27	28	15	10
176-2219	1/2	14	15	25.5	29.5	32	20	10

SILENCER

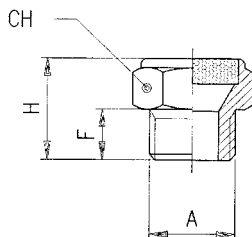

Stock No.	A	F	H	CH	dB*	Pack
176-2220	1/8	8	15	14	73	10
176-2221	1/4	8	15	17	74	10

Push-On Fittings

The RS PRO range of push-on brass fittings are designed to connect safely with thermoplastic tubes in pneumatic and fluid applications. The sealing is metallic and the connection is easy, thanks to the particular shape of the hose adaptor.

The hexagon of the locking nut is always on top to facilitate mounting.

Features

Main advantages

- Tested technology
- All fluids compatibility
- Safely connection
- Metallic sealing
- Mechanical resistance
- Silicon free

Applications

- Compressed air
- Pneumatic automation
- Industrial cooling
- Inert gases, steam
- Inkjet printing
- Vacuum

STRAIGHT MALE ADAPTOR (TAPER)

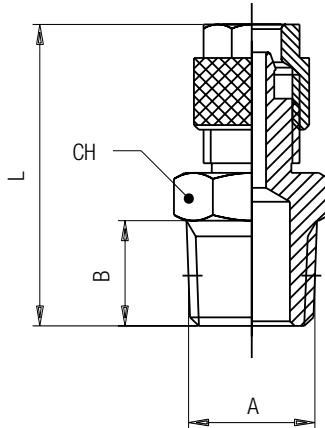

Stock No.	Tube	A	B	L	CH	Pack
176-0923	4/2.7	1/8	7.5	23.5	12	10
176-0924	6/4	1/8	7.5	25.6	12	10
176-0925	6/4	1/4	11	29.6	14	10
176-0926	8/6	1/4	11	30.9	14	10
176-0928	8/6	3/8	11.5	31.4	17	10
176-0929	10/8	1/4	11	33	14	10
176-0930	10/8	3/8	11.5	33.5	17	10
176-0931	12/10	3/8	11.5	35	17	10
176-0932	12/10	1/2	14	38	22	10

STRAIGHT MALE ADAPTOR (PARALLEL)

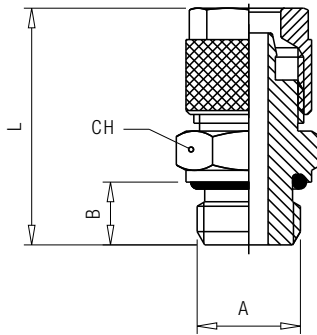

Stock No.	Tube	A	B	L	CH	Pack
176-0934	4/2.7	1/8	6	23	13	10
176-0935	6/4	1/8	6	25.1	13	10
176-0936	6/4	1/4	8	28.1	16	10
176-0937	8/6	1/8	6	26.4	14	10
176-0938	8/6	1/4	8	29.4	16	10
176-0939	8/6	3/8	9	30.4	19	10
176-0940	10/8	1/4	8	31.5	16	10
176-0941	10/8	3/8	9	32.5	19	10
176-0942	12/10	3/8	9	34	19	10
176-0943	12/10	1/2	10	36	24	10

STRAIGHT FEMALE ADAPTOR

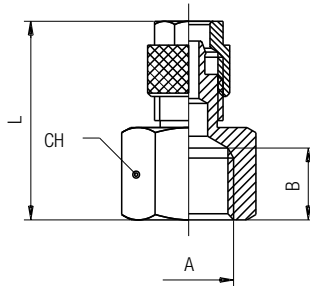

Stock No.	Tube	A	B	L	CH	Pack
176-0944	6/4	1/8	8.5	23.3	14	10
176-0945	6/4	1/4	11	27	17	10
176-0946	8/6	1/4	11	28.7	17	10
176-0947	8/6	3/8	11.5	29.2	22	10
176-0948	10/8	1/4	11	30.5	17	10
176-0950	10/8	3/8	11.5	31	22	10

STRAIGHT CONNECTOR

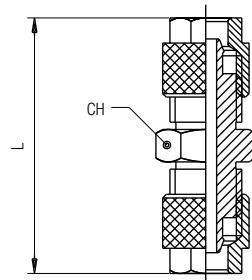

Stock No.	Tube	L	CH	Pack
176-2240	4/2.7	27.5	8	10
176-2241	6/4	32.2	12	10
176-2242	8/6	34.8	12	10
176-2243	10/8	39	14	10

BULKHEAD CONNECTOR

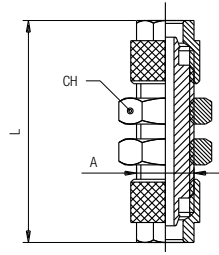

Stock No.	Tube	A	L	CH	Pack
176-2244	4/2.7	M6×0.5	35	10	10
176-2245	6/4	M10×1	45.5	14	10
176-2246	8/6	M12×1	48.4	17	10
176-2247	10/8	M14×1	52	17	10

ELBOW MALE ADAPTOR (TAPER)

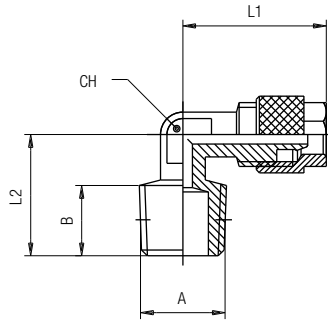

Stock No.	Tube	A	B	L1	L2	CH	Pack
176-0951	4/2.7	1/8	7.5	19.5	15	8	10
176-0952	6/4	1/8	7.5	19.5	15	8	10
176-0953	6/4	1/4	11	20.6	19	8	10
176-0954	8/6	1/8	7.5	19.9	16.5	9	10
176-0956	8/6	1/4	11	21.9	19	9	10
176-0957	8/6	3/8	11.5	23.4	21	9	10
176-0958	10/8	1/4	11	24	22	11	10
176-0959	10/8	3/8	12.5	25.5	22.5	11	10

ORIENTING ELBOW MALE ADAPTOR (PARALLEL)

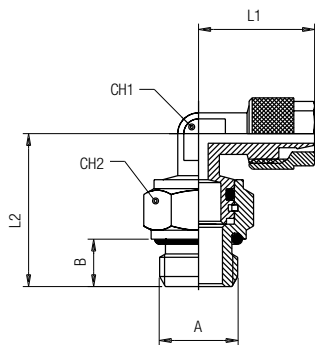

Stock No.	Tube	A	B	L1	L2	CH1	CH2	Pack
176-0960	6/4	1/8	6	20.6	22	8	13	10
176-0962	6/4	1/4	8	20.6	26	8	16	10
176-0963	8/6	1/8	6	21.6	21.6	9	13	10
176-0964	8/6	1/4	8	23.1	26.5	9	16	10
176-0965	10/8	1/4	8	24	27.5	11	16	10
176-0966	4/2.7	1/8	6	18.5	22	8	13	10

ELBOW CONNECTOR

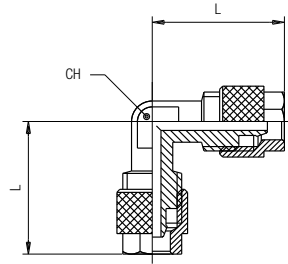

Stock No.	Tube	L	CH	Pack
176-2249	4/2.7	20	8	10
176-2250	6/4	20.6	8	10
176-2251	8/6	21.9	9	10
176-2252	10/8	25.5	11	10

TEE MALE ADAPTOR (TAPER) - CENTRE LEG

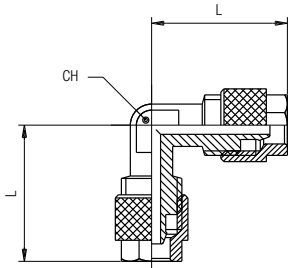

Stock No.	Tube	A	B	L1	L2	CH	Pack
176-0967	4/2.7	1/8	7.5	37	15.5	8	10
176-0968	5/3	1/8	7.5	39	15.5	8	10
176-0969	6/4	1/8	7.5	39	15.5	8	10
176-0970	8/6	1/8	7.5	39.8	16.5	9	10
176-0971	8/6	1/4	11	43.8	20.5	9	10

ORIENTING TEE MALE ADAPTOR (PARALLEL) - CENTRE LEG

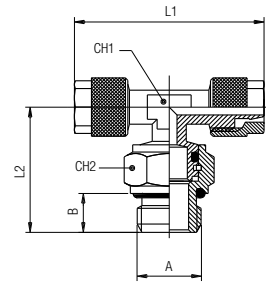

Stock No.	Tube	A	B	L1	L2	CH1	CH2	Pack
176-0972	6/4	1/8	6	41.2	22	8	13	10
176-0973	6/4	1/4	8	41.2	26	8	16	10
176-0974	8/6	1/8	6	43.2	24	9	13	10
176-0975	8/6	1/4	8	43.2	27.5	9	16	10
176-0976	10/8	1/4	8	48	27.5	11	16	10

TEE CONNECTOR

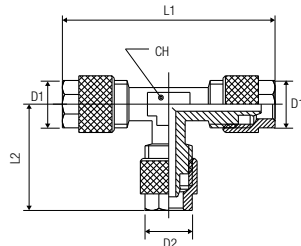

Stock No.	D1	L1	L2	CH	Pack
176-2253	4/2.7	40	20.5	8	10
176-2255	6/4	41.2	20.6	8	10
176-2256	8/6	43.8	21.9	9	10
176-2257	10/8	51	25.5	11	10

STEEL AND NBR CENTERING BIMATERIAL WASHER

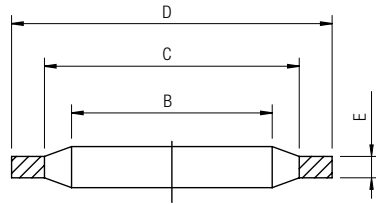

Stock No.	Size	B	C	D	E	Pack
176-1749	1/8	10.4	12	14.7	1.25	20
176-1750	1/4	13.85	15.75	18.7	1.25	20
176-1751	3/8	17.35	19.25	22.7	1.25	20
176-1752	1/2	21.65	23.55	26.7	1.25	20
176-1753	3/4	27.3	29.2	32.5	1.25	20

TUBE CUTTER

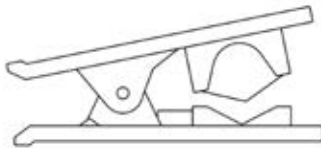

Stock No.	Colour	Pack	Max Size Cut
176-0977	Red	10	15 mm
172-8969	Black	1	15 mm

TUBE CUTTER



Stock No.	Colour	Pack	Max Size Cut
828-0223	Red	1	13 mm

Function Fittings

When specific pneumatic operations are required, RS PRO function fittings are designed to carry these out. Made from brass, stainless steel 316L, technopolymer and aluminium, they respond to the most extreme demands of pneumatics: flow controls, pressure regulators, unidirectional valves, block valves, check valves, quick exhaust valves, logic elements, slide valves, etc.

Features

Main advantages

- Compact and sharp in pneumatic
- Limited pressure drop
- Easy to handle
- Function repeatability
- Range of materials
- Silicon free

Applications

- Pneumatic automation
- Automotive processes
- Food & beverage
- Fluid technology
- Vacuum

ORIENTING FLOW REGULATOR FOR CYLINDER (PARALLEL)

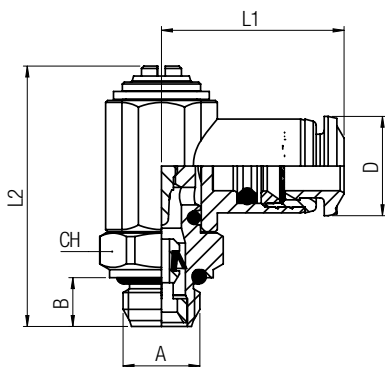

Stock No.	Tube	A	B	L1	L2	CH	D	Pack
176-1876	4	1/8	5,5	21,5	31	14	10	10
176-1877	6	1/8	5,5	23	31	14	12,5	10
176-1878	6	1/4	5,5	25,5	36,5	17	12,5	10
176-1880	8	1/8	5,5	23,5	31	14	14	10
176-1881	8	1/4	7	26	36,5	17	14	10
176-1882	8	3/8	8	27	42,5	20	14	10

ORIENTING FLOW REGULATOR FOR CYLINDER (PARALLEL)

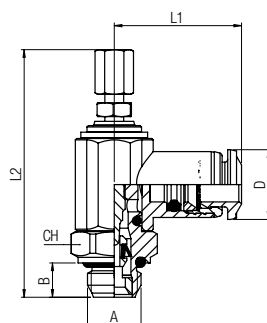

Stock No.	Tube	A	B	L1	L2	CH	D	Pack
176-1883	6	1/4	5,5	25,5	36,5	17	12,5	10
176-1884	8	1/8	5,5	23,5	31	14	14	10
176-1886	8	1/4	7	26	36,5	17	14	10
176-1887	8	3/8	8	27	42,5	20	14	10
176-1888	10	3/8	8	30	42,5	20	17	10

TUBE IN-LINE NEEDLE VALVE (UNIDIRECTIONAL FLOW)

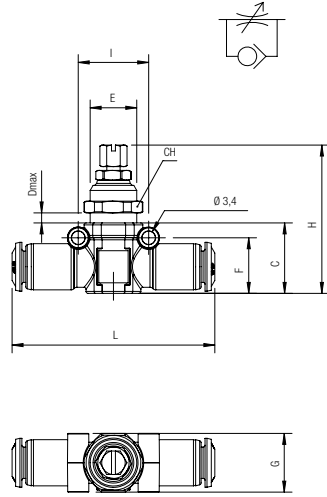

Stock No.	Tube	C	D	E	F	G	H	I	L	CH	Pack
176-1892	4	18	4	M12×1	14.5	15	37.5+43.5	18	52	14	10
176-1889	6	18	6	M12×1	14.5	15	37.5+43.5	18	52	14	10
176-1890	8	20	6.5	M14×1	16.5	17	39.5+45.5	20	58	16	10
176-1891	10	23.5	8	M16×1	19.5	19	47.5+53.5	22.5	67	18	10

UNI-DIRECTIONAL FLOW REGULATOR

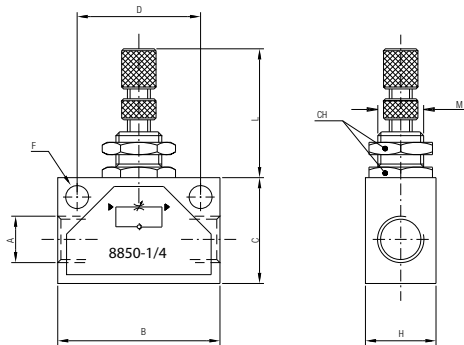

Stock No.	A	B	C	H	D	F	L	M	CH	Pack
176-1755	1/8	35	22	18	24.7	4.5	26-36	M12×0.75	15	10
176-1757	1/4	46	30	20	35	6.5	26-36	M12×0.75	15	10
176-1758	3/8	50	30	25	35	6.5	32-42	M18×1.5	22	10
176-1759	1/2	60	40	25	44	6.5	32-44	M18×1.5	22	10
176-1754	M5	25	15	12	18	4.5	20-27	M10×0.75	12	10

QUICK EXHAUST VALVE

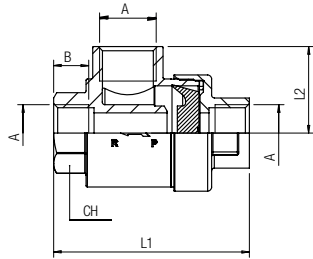

Stock No.	A	B	L1	L2	CH	Pack
176-2258	1/8	8.5	42	19.5	15	10
176-2259	1/4	11	54	25	19	10
176-2261	3/8	12	60.5	26.5	22	10
176-2262	1/2	15	72	32	26	10
176-2263	3/4	18.5	88	37	32	5

SLIDE VALVE

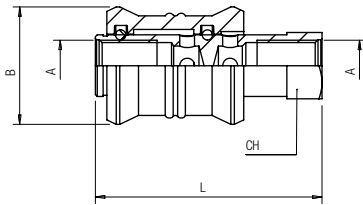

Stock No.	A	B	L	CH	Pack
176-2264	1/4	30	58	17	10
176-2265	3/8	35	70	22	5

FEMALE-FEMALE NON RETURN VALVE

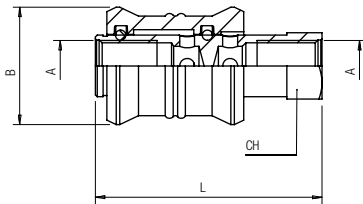

Stock No.	A	B	L	CH	Pack
176-2266	1/8	8.5	35.5	13	10
176-2267	1/4	11	43	17	10
176-2268	3/8	12	58	24	10
176-2269	1/2	15	63	24	10

PUSH-IN CONNECTIONS NON-RETURN VALVE

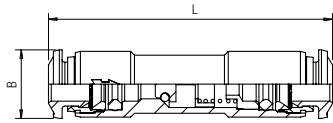

Stock No.	Tube	L	B	Pack
176-2270	4	44.5	10	10
176-2271	6	52	12.5	10
176-2272	8	56	14	10

UNIDIRECTIONAL BLOCK VALVE

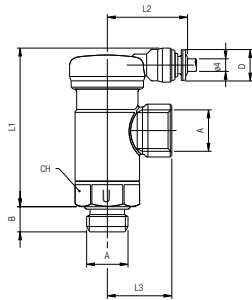

Stock No.	A	B	L1	L2	L3	CH	D	Pack
176-2147	1/8	6	50	25	18.5	18	11	5
176-2148	1/4	8	50.5	25	20.5	18	11	5

BIDIRECTIONAL BLOCK VALVE

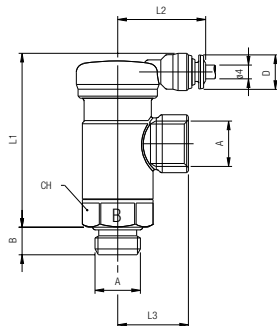

Stock No.	A	B	L1	L2	L3	CH	D	Pack
176-2149	1/8	6	50	25	18.5	18	11	5
176-2150	1/4	8	50.5	25	20.5	18	11	5

Quick Couplings

Fully made of stainless steel AISI 316L, our quick couplings range has been developed to drive corrosive fluids or to be used in aggressive environments. It is ideal for direct contact with food fluids.

This line can be used in salty environments and on machines that need frequent washing with aggressive detergents.

The series conforms to NSF 61, NSF 169 & NSF 372.

Features

Main advantages

- DN 2,5 - 12 mm
- Standard profiles
- Multisocket
- Single handed operation
- Light and compact
- Safety version
- Moulding couplers
- Silicon Free

Applications

- Compressed air & tools
- Pneumatic & fluidtechnology
- Food & beverage
- Life & sciences
- Cooling system
- Inert gases, vacuum

MALE SOCKET

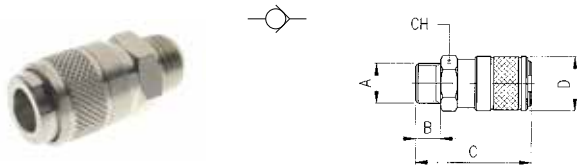

RS PRO DN5 quick connect couplings with MIGNON profile. Interchangeable with RECTUS/LEGRIS, PARKER 21/90, CAMOZZI 5050 - 5150, CEJN 220 and FESTO KD - KS 3.

Product details

- Working Pressure: 0 bar to 12 bar (1.2 MPa)
- Working Temperature: - 20 °C to + 80 °C
- Fluid: Compressed Air

Stock No.	A	B	C	D	CH	Pack
176-1899	1/8	6	35.5	18	16	10
176-1900	1/4	8	37.5	18	16	10

FEMALE SOCKET

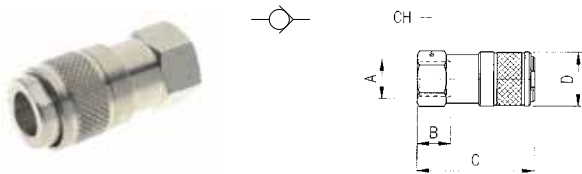

RS PRO DN5 quick connect couplings with MIGNON profile. Interchangeable with RECTUS/LEGRIS, PARKER 21/90, CAMOZZI 5050 - 5150, CEJN 220 and FESTO KD - KS 3.

Product details

- Working Pressure: 0 bar to 12 bar (1.2 MPa)
- Working Temperature: - 20 °C to + 80 °C
- Fluid: Compressed Air

Stock No.	A	B	C	D	CH	Pack
176-1901	1/8	7.5	35	18	16	10
176-1902	1/4	11	38.5	18	16	10

SOCKET WITH REST FOR RUBBER HOSE

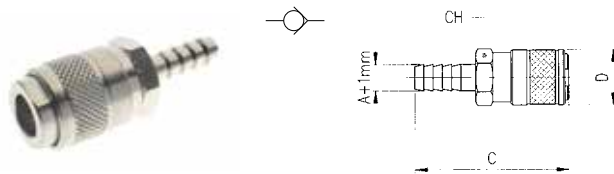

RS PRO DN5 quick connect couplings with MIGNON profile. Interchangeable with RECTUS/LEGRIS, PARKER 21/90, CAMOZZI 5050 - 5150, CEJN 220 and FESTO KD - KS 3.

Product details

- Working Pressure: 0 bar to 12 bar (1.2 MPa)
- Working Temperature: - 20 °C to + 80 °C
- Fluid: Compressed Air

Stock No.	A	B	C	D	CH	Pack
176-1903	4	-	48	18	16	10
176-1904	6	-	48	18	16	10
176-1905	8	-	48	18	16	10

BULKHEAD SOCKET WITH SPIGOT FOR RUBBER HOSE

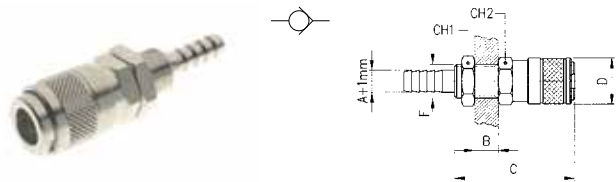

RS PRO DN5 quick connect couplings with MIGNON profile. Interchangeable with RECTUS/LEGRIS, PARKER 21/90, CAMOZZI 5050 - 5150, CEJN 220 and FESTO KD - KS 3.

Product details

- Working Pressure: 0 bar to 12 bar (1.2 MPa)
- Working Temperature: - 20 °C to + 80 °C
- Fluid: Compressed Air

Stock No.	A	B	C	D	F	CH1	CH2	Pack
176-1906	4	8	61	18	M10×1	14	16	10
176-1907	6	8	61	18	M12×1	17	16	10

MALE PLUG



RS PRO DN5 quick connect couplings with MIGNON profile. Interchangeable with RECTUS/LEGRIS, PARKER 21/90, CAMOZZI 5050 - 5150, CEJN 220 and FESTO KD - KS 3.

Product details

- Working Pressure: 0 bar to 12 bar (1.2 MPa)
- Working Temperature: - 20 °C to + 80 °C
- Fluid: Compressed Air

Stock No.	A	B	C	D	CH	Pack
176-1944	1/8	6	26	-	14	10
176-1945	1/4	8	28.5	-	17	10

FEMALE PLUG



RS PRO DN5 quick connect couplings with MIGNON profile. Interchangeable with RECTUS/LEGRIS, PARKER 21/90, CAMOZZI 5050 - 5150, CEJN 220 and FESTO KD - KS 3.

Product details

- Working Pressure: 0 bar to 12 bar (1.2 MPa)
- Working Temperature: - 20 °C to + 80 °C
- Fluid: Compressed Air

Stock No.	A	B	C	D	CH	Pack
176-1946	1/8	7.5	25	-	14	10
176-1947	1/4	11	28.5	-	17	10

PLUG WITH REST FOR RUBBER HOSE

RS PRO DN5 quick connect couplings with MIGNON profile. Interchangeable with RECTUS/LEGRIS, PARKER 21/90, CAMOZZI 5050 - 5150, CEJN 220 and FESTO KD - KS 3.

Product details

- Working Pressure: 0 bar to 12 bar (1.2 MPa)
- Working Temperature: - 20 °C to + 80 °C
- Fluid: Compressed Air



Stock No.	A	B	C	D	CH	Pack
176-1948	4	-	35	9	-	10
176-1949	6	-	35	9	-	10
176-1950	8	-	38	12	-	10

MALE SOCKET

RS PRO DN5.5 quick connect couplings according to UNI ISO 6150 B12. Interchangeable with RECTUS/LEGRIS 23/24, PARKER 20/30 - 1/4, TEMA 1400, HANSEN 3000, CEJN 310, INDUSTRIAL 1/4, GROMELLE 600 and US-MIL SPEC C-4109.

Product details

- Working Pressure: 0 bar to 16 bar (1.6 MPa)
- Working Temperature: - 20 °C to + 80 °C
- Fluid: Compressed Air

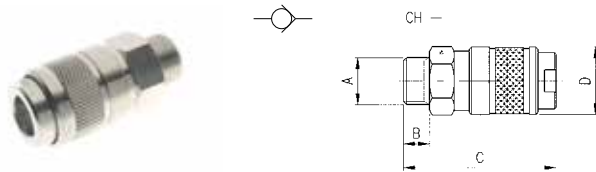

Stock No.	A	B	C	D	CH	Pack
176-1908	1/4	8	53	24	21	10
176-1909	3/8	9	54	24	21	10
176-1910	1/2	10	55	24	24	10

FEMALE SOCKET

RS PRO DN5.5 quick connect couplings according to UNI ISO 6150 B12. Interchangeable with RECTUS/LEGRIS 23/24, PARKER 20/30 - 1/4, TEMA 1400, HANSEN 3000, CEJN 310, INDUSTRIAL 1/4, GROMELLE 600 and US-MIL SPEC C-4109.

Product details

- Working Pressure: 0 bar to 16 bar (1.6 MPa)
- Working Temperature: - 20 °C to + 80 °C
- Fluid: Compressed Air

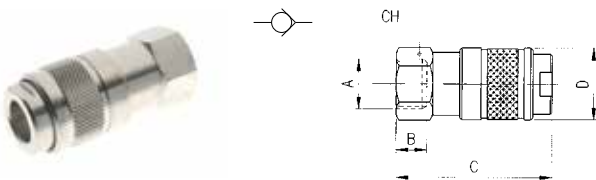

Stock No.	A	B	C	D	CH	Pack
176-1911	3/8	11.5	55.5	24	21	10

SOCKET WITH REST FOR RUBBER HOSE

RS PRO DN5.5 quick connect couplings according to UNI ISO 6150 B12. Interchangeable with RECTUS/LEGRIS 23/24, PARKER 20/30 - 1/4, TEMA 1400, HANSEN 3000, CEJN 310, INDUSTRIAL 1/4, GROMELLE 600 and US-MIL SPEC C-4109.

Product details

- Working Pressure: 0 bar to 16 bar (1.6 MPa)
- Working Temperature: - 20 °C to + 80 °C
- Fluid: Compressed Air

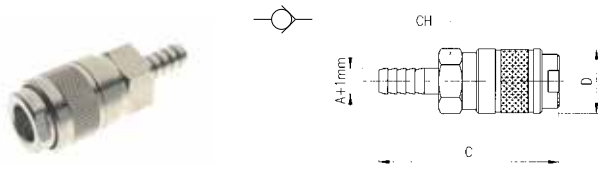

Stock No.	A	B	C	D	CH	Pack
176-1912	6	-	64	24	21	10
176-1913	8	-	64	24	21	10
176-1914	10	-	64	24	21	10

STEEL MALE PLUG

RS PRO DN5.5 quick connect couplings according to UNI ISO 6150 B12. Interchangeable with RECTUS/LEGRIS 23/24, PARKER 20/30 - 1/4, TEMA 1400, HANSEN 3000, CEJN 310, INDUSTRIAL 1/4, GROMELLE 600 and US-MIL SPEC C-4109.

Product details

- Working Pressure: -0.99 bar (-0.099 MPa) to 15 bar (1.5 MPa)
- Working Temperature: - 20 °C to + 80 °C
- Fluid: Compressed Air

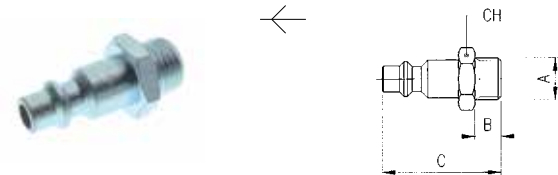

Stock No.	A	B	C	D	CH	Pack
176-1105	1/4	8	36.5	-	17	10
176-1106	3/8	9	37.5	-	19	10
176-1107	1/2	10	39	-	24	10

STEEL FEMALE PLUG

RS PRO DN5.5 quick connect couplings according to UNI ISO 6150 B12. Interchangeable with RECTUS/LEGRIS 23/24, PARKER 20/30 - 1/4, TEMA 1400, HANSEN 3000, CEJN 310, INDUSTRIAL 1/4, GROMELLE 600 and US-MIL SPEC C-4109.

Product details

- Working Pressure: -0.99 bar (-0.099 MPa) to 15 bar (1.5 MPa)
- Working Temperature: - 20 °C to + 80 °C
- Fluid: Compressed Air



Stock No.	A	B	C	D	CH	Pack
176-1108	1/4	11	36.5	-	17	10
176-1109	3/8	11.5	37	-	19	10
176-1110	1/2	14	39.5	-	24	10

STEEL PLUG WITH REST FOR RUBBER HOSE

RS PRO DN5.5 quick connect couplings according to UNI ISO 6150 B12. Interchangeable with RECTUS/LEGRIS 23/24, PARKER 20/30 - 1/4, TEMA 1400, HANSEN 3000, CEJN 310, INDUSTRIAL 1/4, GROMELLE 600 and US-MIL SPEC C-4109.

Product details

- Working Pressure: -0.99 bar (-0.099 MPa) to 15 bar (1.5 MPa)
- Working Temperature: - 20 °C to + 80 °C
- Fluid: Compressed Air

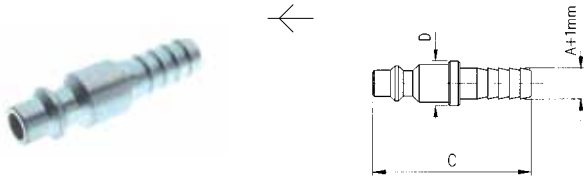

Stock No.	A	B	C	D	CH	Pack
176-1272	6	-	43.5	12	-	10
176-1274	8	-	43.5	12	-	10
176-1760	10	-	46	14	-	10

MALE SOCKET

RS PRO DN5.5 quick connect couplings according to UNI ISO 6150 C 10. Interchangeable with RECTUS/LEGRIS 18.

Product details

- Working Pressure: 0 bar to 25 bar (2,5 MPa)
- Working Temperature: - 20 °C to + 80 °C
- Fluid: Compressed Air

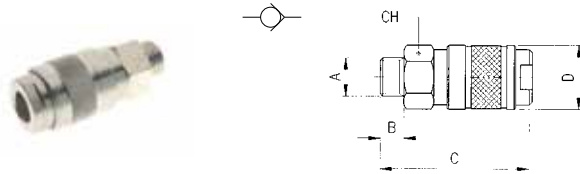

Stock No.	A	B	C	D	CH	Pack
176-1915	1/4	8	51	22	19	10
176-1916	3/8	9	52	22	19	10

FEMALE SOCKET

RS PRO DN5.5 quick connect couplings according to UNI ISO 6150 C 10. Interchangeable with RECTUS/LEGRIS 18.

Product details

- Working Pressure: 0 bar to 25 bar (2,5 MPa)
- Working Temperature: - 20 °C to + 80 °C
- Fluid: Compressed Air

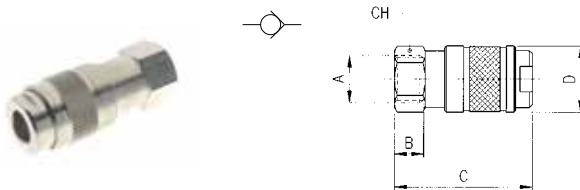

Stock No.	A	B	C	D	CH	Pack
176-1917	1/4	11	53	22	19	10
176-1918	3/8	11.5	53.5	22	20	10

SOCKET WITH REST FOR RUBBER HOSE

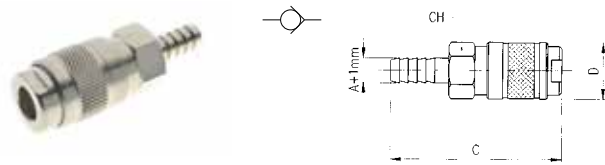

RS PRO DN5.5 quick connect couplings according to UNI ISO 6150 C 10. Interchangeable with RECTUS/LEGRIS 18.

Product details

- Working Pressure: 0 bar to 25 bar (2,5 MPa)
- Working Temperature: - 20 °C to + 80 °C
- Fluid: Compressed Air

Stock No.	A	B	C	D	CH	Pack
176-1919	8	-	62.5	22	19	10
176-1920	10	-	62.5	22	19	10

MALE PLUG

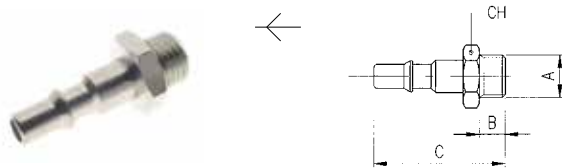

RS PRO DN5.5 quick connect couplings according to UNI ISO 6150 C 10. Interchangeable with RECTUS/LEGRIS 18.

Product details

- Working Pressure: 0 bar to 25 bar (2,5 MPa)
- Working Temperature: - 20 °C to + 80 °C
- Fluid: Compressed Air

Stock No.	A	B	C	D	CH	Pack
176-1951	1/4	8	41.5	-	17	10
176-1952	3/8	9	42.5	-	19	10

**RUBBER HOOSING
IT MATTERS.**

Explore the RS PRO range of rubber tubing and hosing for fluid, gases and solids.

rspro.com



STEEL MALE PLUG

RS PRO DN5.5 quick connect couplings according to UNI ISO 6150 B12. Interchangeable with RECTUS/LEGRIS 23/24, PARKER 20/30 - 1/4, TEMA 1400, HANSEN 3000, CEJN 310, INDUSTRIAL 1/4, GROMELLE 600 and US-MIL SPEC C-4109.

Product details

- Working Pressure: -0.99 bar [-0.099 MPa] to 15 bar [1.5 MPa]
- Working Temperature: - 20 °C to + 80 °C
- Fluid: Compressed Air

Stock No.	A	B	C	D	CH	Pack
176-1111	1/4	8	41.5	-	17	10

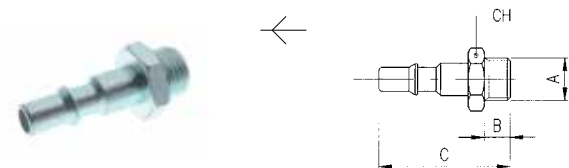

PLUG WITH REST FOR RUBBER HOSE

RS PRO DN5.5 quick connect couplings according to UNI ISO 6150 C 10. Interchangeable with RECTUS/LEGRIS 18.

Product details

- Working Pressure: 0 bar to 25 bar [2,5 MPa]
- Working Temperature: - 20 °C to + 80 °C
- Fluid: Compressed Air

Stock No.	A	B	C	D	CH	Pack
176-1955	6	-	48	10	-	10
176-1956	8	-	51	12	-	10
176-1957	10	-	51	14	-	10



MALE SOCKET

RS PRO DN7.5 - 7.8 quick connect couplings with EUROPEAN profile. Interchangeable with RECTUS/LEGRIS 25/26/1600/1625, TEMA 1600, CAMOZZI 5080 - 5180, CEJN 320 and FESTO KD - KS 6, KD - KS 4.

Product details

- Working Pressure: 0 bar to 16 bar [1,6 MPa]
- Working Temperature: - 20 °C to + 80 °C
- Fluid: Compressed Air

Stock No.	A	B	C	D	CH	Pack
176-1921	1/4	8	48	24	21	10

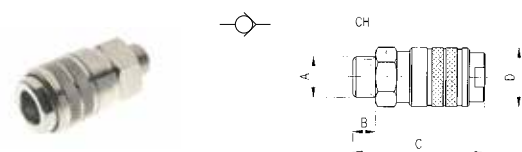

SOCKET WITH REST FOR RUBBER HOSE

RS PRO DN7.5 - 7.8 quick connect couplings with EUROPEAN profile. Interchangeable with RECTUS/LEGRIS 25/26/1600/1625, TEMA 1600, CAMOZZI 5080 - 5180, CEJN 320 and FESTO KD - KS 6, KD - KS 4.

Product details

- Working Pressure: 0 bar to 16 bar [1,6 MPa]
- Working Temperature: - 20 °C to + 80 °C
- Fluid: Compressed Air

Stock No.	A	B	C	D	CH	Pack
176-1922	6	-	61	24	21	10
176-1923	8	-	61	24	21	10
176-1924	10	-	61	24	21	10
176-1925	12	-	61	24	21	10

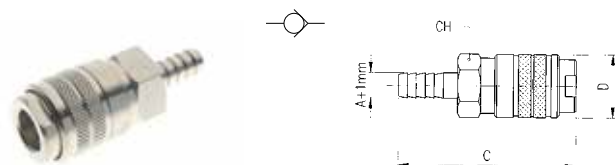

MALE SOCKET FOR SHUTTER PLUG

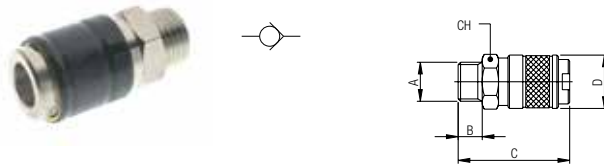

RS PRO DN5 quick connect couplings with MIGNON DOUBLE SHUT OFF profile. Interchangeable with RECTUS/LEGRIS, PARKER 21/90, CAMOZZI 5050 - 5150 and CEJN 200.

Product details

- Working Pressure: 0 bar to 12 bar (1.2 MPa)
- Working Temperature: - 20 °C to + 80 °C
- Fluid: Compressed Air

Stock No.	A	B	C	D	CH	Pack
176-1926	1/8	6	35.5	18	16	10
176-1927	1/4	8	37.5	18	16	10

FEMALE SOCKET FOR SHUTTER PLUG

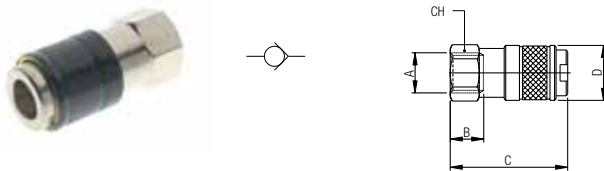

RS PRO DN5 quick connect couplings with MIGNON DOUBLE SHUT OFF profile. Interchangeable with RECTUS/LEGRIS, PARKER 21/90, CAMOZZI 5050 - 5150 and CEJN 200.

Product details

- Working Pressure: 0 bar to 12 bar (1.2 MPa)
- Working Temperature: - 20 °C to + 80 °C
- Fluid: Compressed Air

Stock No.	A	B	C	D	CH	Pack
176-1928	1/8	7.5	35	18	16	10
176-1929	1/4	11	38.5	18	16	10

SOCKET WITH REST FOR RUBBER HOSE FOR SHUTTER PLUG

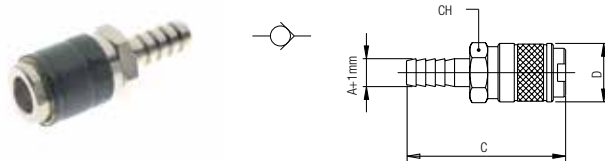

RS PRO DN5 quick connect couplings with MIGNON DOUBLE SHUT OFF profile. Interchangeable with RECTUS/LEGRIS, PARKER 21/90, CAMOZZI 5050 - 5150 and CEJN 200.

Product details

- Working Pressure: 0 bar to 12 bar (1.2 MPa)
- Working Temperature: - 20 °C to + 80 °C
- Fluid: Compressed Air

Stock No.	A	B	C	D	CH	Pack
176-1930	4	-	48	18	16	10
176-1931	6	-	48	18	16	10

MALE SHUTTER PLUG

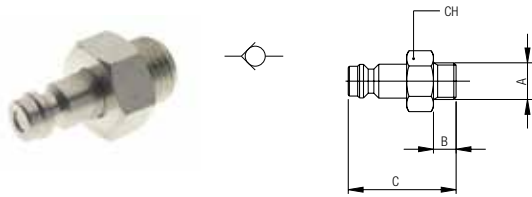

RS PRO DN5 quick connect couplings with MIGNON DOUBLE SHUT OFF profile. Interchangeable with RECTUS/LEGRIS, PARKER 21/90, CAMOZZI 5050 - 5150 and CEJN 200.

Product details

- Working Pressure: 0 bar to 12 bar (1.2 MPa)
- Working Temperature: - 20 °C to + 80 °C
- Fluid: Compressed Air

Stock No.	A	B	C	D	CH	Pack
176-1959	1/8	6	29.5	-	14	10
176-1960	1/4	8	31.5	-	17	10

FEMALE SHUTTER PLUG

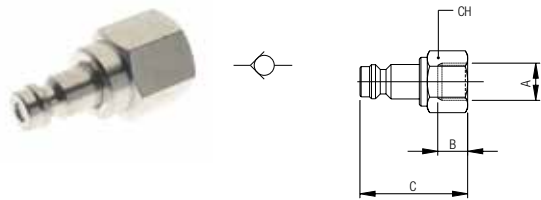

RS PRO DN5 quick connect couplings with MIGNON DOUBLE SHUT OFF profile. Interchangeable with RECTUS/LEGRIS, PARKER 21/90, CAMOZZI 5050 - 5150 and CEJN 200.

Product details

- Working Pressure: 0 bar to 12 bar (1.2 MPa)
- Working Temperature: - 20 °C to + 80 °C
- Fluid: Compressed Air

Stock No.	A	B	C	D	CH	Pack
176-1961	1/8	7.5	31.5	-	14	10
176-1962	1/4	11	35	-	17	10

MALE SOCKET

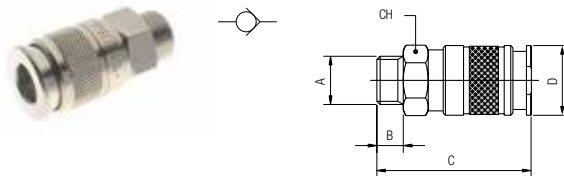

RS PRO quick connect couplings with MULTISOCKET profile. Interchangeable with a wide range of standards such as EUROPEAN, SWISS, ITALIAN, UNI-ISO 6150-B12 and INDUSTRIAL 1/4. For suitability with other manufacturer series please refer to the available datasheet.

Product details

- Working Pressure: 0 bar to 16 bar (1.6 MPa)
- Working Temperature: - 20 °C to + 80 °C
- Fluid: Compressed Air

Stock No.	A	B	C	D	CH	Pack
176-1933	1/4	8	49	24	21	10
176-1934	3/8	9	50	24	21	10
176-1935	1/2	10	51	24	24	10

FEMALE SOCKET

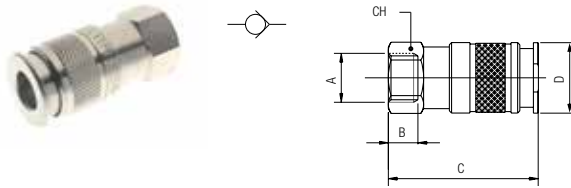

RS PRO quick connect couplings with MULTISOCKET profile. Interchangeable with a wide range of standards such as EUROPEAN, SWISS, ITALIAN, UNI-ISO 6150-B12 and INDUSTRIAL 1/4. For suitability with other manufacturer series please refer to the available datasheet.

Product details

- Working Pressure: 0 bar to 16 bar (1,6 MPa)
- Working Temperature: - 20 °C to + 80 °C
- Fluid: Compressed Air

Stock No.	A	B	C	D	CH	Pack
176-1936	1/4	11	51	24	21	10
176-1937	3/8	11.5	51	24	21	10
176-1938	1/2	14	55	24	24	10

SOCKET WITH REST FOR RUBBER HOSE

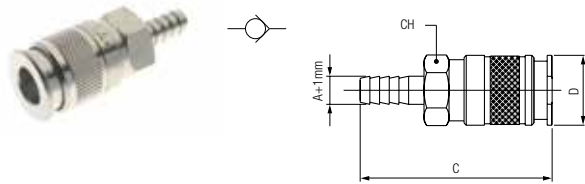

RS PRO quick connect couplings with MULTISOCKET profile. Interchangeable with a wide range of standards such as EUROPEAN, SWISS, ITALIAN, UNI-ISO 6150-B12 and INDUSTRIAL 1/4. For suitability with other manufacturer series please refer to the available datasheet.

Product details

- Working Pressure: 0 bar to 16 bar (1,6 MPa)
- Working Temperature: - 20 °C to + 80 °C
- Fluid: Compressed Air

Stock No.	A	B	C	D	CH	Pack
176-1939	6	-	61	24	21	10
176-1940	8	-	61	24	21	10
176-1941	10	-	61	24	21	10

MALE SOCKET

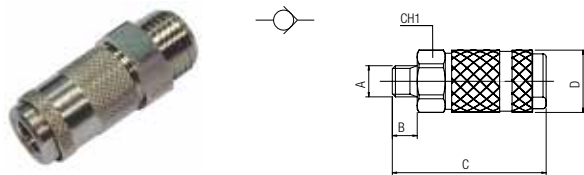

RS PRO DN2.7 quick connect couplings with MINI profile. Interchangeable with RECTUS/LEGRIS, PARKER 20/91 and FESTO KD - KS 2.

Product details

- Working Pressure: 0 bar to 12 bar (1,2 MPa)
- Working Temperature: - 20 °C to + 80 °C
- Fluid: Compressed Air

Stock No.	A	B	C	D	CH1	Pack
176-2000	1/8	26,5	6	10	11	10
176-1999	M5	24,5	4	10	9	10

FEMALE SOCKET

RS PRO DN2.7 quick connect couplings with MINI profile. Interchangeable with RECTUS/LEGRIS, PARKER 20/91 and FESTO KD - KS 2.

Product details

- Working Pressure: 0 bar to 12 bar (1.2 MPa)
- Working Temperature: - 20 °C to + 80 °C
- Fluid: Compressed Air

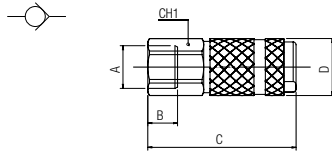

Stock No.	A	B	C	D	CH1	Pack
176-2003	1/8	28	7,5	10	12	10
176-2001	M5	26	5,5	10	9	10

FEMALE PLUG

RS PRO DN2.7 quick connect couplings with MINI profile. Interchangeable with RECTUS/LEGRIS, PARKER 20/91 and FESTO KD - KS 2.

Product details

- Working Pressure: 0 bar to 12 bar (1.2 MPa)
- Working Temperature: - 20 °C to + 80 °C
- Fluid: Compressed Air

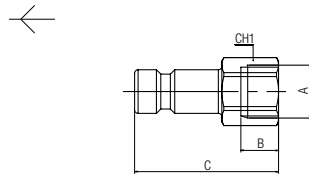

Stock No.	A	B	C	CH1	Pack
176-2008	1/8	7.5	18.5	12	10
176-2009	M5	5.5	16.5	7	10

MALE SOCKET

RS PRO quick connect couplings according to UNI ISO 6150 B-15 (B-SOCKET DN9) and EUROPEAN DN10 standard. Interchangeable with RECTUS/LEGRIS 30 and 27, PARKER 30 - 3/8, HANSEN 4000, CEJN 410 and 430, INDUSTRIAL 3/8, GROMELLE 900 and US - MIL SPEC C-4109.

Product details

- Working Pressure: 0 bar to 16 bar (1.6 MPa)
- Working Temperature: - 20 °C to + 80 °C
- Fluid: Compressed Air

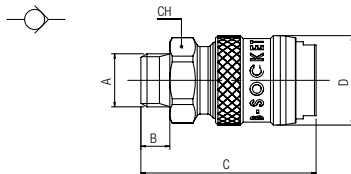

Stock No.	A	B	C	D	CH	Pack
176-2004	3/8	9	54,5	28	24	10
176-2005	1/2	10	55,5	28	24	10

FEMALE SOCKET

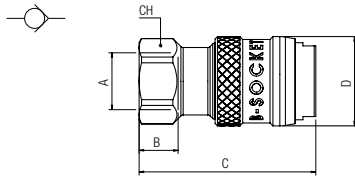

RS PRO quick connect couplings according to UNI ISO 6150 B-15 (B-SOCKET DN9) and EUROPEAN DN10 standard. Interchangeable with RECTUS/LEGRIS 30 and 27, PARKER 30 - 3/8, HANSEN 4000, CEJN 410 and 430, INDUSTRIAL 3/8, GROMELLE 900 and US - MIL SPEC C-4109.

Product details

- Working Pressure: 0 bar to 16 bar (1.6 MPa)
- Working Temperature: - 20 °C to + 80 °C
- Fluid: Compressed Air

Stock No.	A	B	C	D	CH	Pack
176-2006	3/8	11,5	55	28	24	10
176-2007	1/2	12	56,5	28	24	10

MALE PLUG

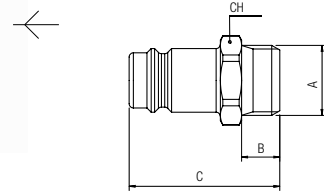

RS PRO quick connect couplings according to UNI ISO 6150 B-15 (B-SOCKET DN9) and EUROPEAN DN10 standard. Interchangeable with RECTUS/LEGRIS 30 and 27, PARKER 30 - 3/8, HANSEN 4000, CEJN 410 and 430, INDUSTRIAL 3/8, GROMELLE 900 and US - MIL SPEC C-4109.

Product details

- Working Pressure: 0 bar to 16 bar (1.6 MPa)
- Working Temperature: - 20 °C to + 80 °C
- Fluid: Compressed Air

Stock No.	A	C	B	CH	Pack
176-2010	3/8	35,5	9	19	10
176-2011	1/2	37	10	24	10

FEMALE PLUG

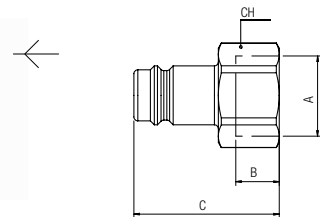

RS PRO quick connect couplings according to UNI ISO 6150 B-15 (B-SOCKET DN9) and EUROPEAN DN10 standard. Interchangeable with RECTUS/LEGRIS 30 and 27, PARKER 30 - 3/8, HANSEN 4000, CEJN 410 and 430, INDUSTRIAL 3/8, GROMELLE 900 and US - MIL SPEC C-4109.

Product details

- Working Pressure: 0 bar to 16 bar (1.6 MPa)
- Working Temperature: - 20 °C to + 80 °C
- Fluid: Compressed Air

Stock No.	A	C	B	CH	Pack
176-2012	3/8	34	11,5	19	10
176-2013	1/2	37	14	24	10

STEEL MALE PLUG

RS PRO DN5.5 quick connect couplings according to UNI ISO 6150 B12. Interchangeable with RECTUS/LEGRIS 23/24, PARKER 20/30 - 1/4, TEMA 1400, HANSEN 3000, CEJN 310, INDUSTRIAL 1/4, GROMELLE 600 and US-MIL SPEC C-4109.

Product details

- Working Pressure: -0.99 bar [-0.099 MPa] to 15 bar [1.5 MPa]
- Working Temperature: - 20 °C to + 80 °C
- Fluid: Compressed Air

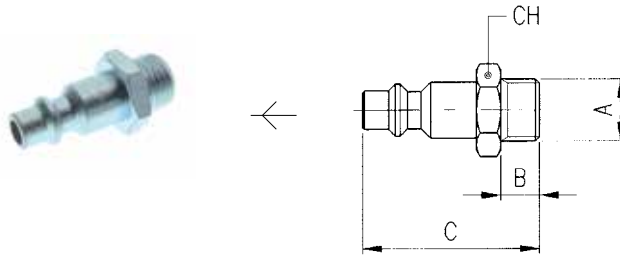

Stock No.	A	B	C	D	CH	Pack
176-1105	1/4	8	36.5	-	17	10
176-1106	3/8	9	37.5	-	19	10
176-1107	1/2	10	39	-	24	10

STEEL FEMALE PLUG

RS PRO DN5.5 quick connect couplings according to UNI ISO 6150 B12. Interchangeable with RECTUS/LEGRIS 23/24, PARKER 20/30 - 1/4, TEMA 1400, HANSEN 3000, CEJN 310, INDUSTRIAL 1/4, GROMELLE 600 and US-MIL SPEC C-4109.

Product details

- Working Pressure: -0.99 bar [-0.099 MPa] to 15 bar [1.5 MPa]
- Working Temperature: - 20 °C to + 80 °C
- Fluid: Compressed Air

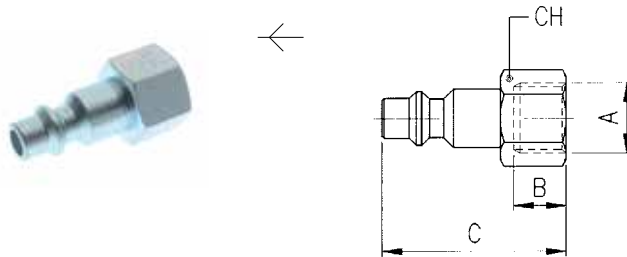

Stock No.	A	B	C	D	CH	Pack
176-1108	1/4	11	36.5	-	17	10
176-1109	3/8	11.5	37	-	19	10
176-1110	1/2	14	39.5	-	24	10

STEEL PLUG WITH REST FOR RUBBER HOSE

RS PRO DN5.5 quick connect couplings according to UNI ISO 6150 B12. Interchangeable with RECTUS/LEGRIS 23/24, PARKER 20/30 - 1/4, TEMA 1400, HANSEN 3000, CEJN 310, INDUSTRIAL 1/4, GROMELLE 600 and US-MIL SPEC C-4109.

Product details

- Working Pressure: -0.99 bar [-0.099 MPa] to 15 bar [1.5 MPa]
- Working Temperature: - 20 °C to + 80 °C
- Fluid: Compressed Air

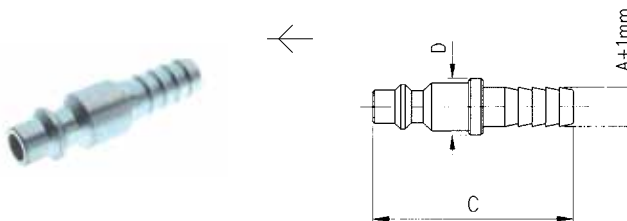

Stock No.	A	B	C	D	CH	Pack
176-1272	6	-	43.5	12	-	10
176-1274	8	-	43.5	12	-	10
176-1760	10	-	46	14	-	10

STEEL MALE PLUG

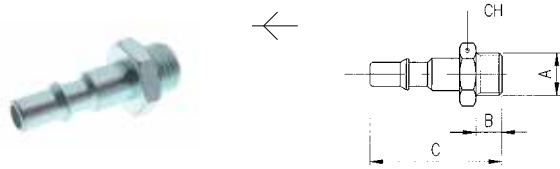

RS PRO DN5.5 quick connect couplings according to UNI ISO 6150 B12. Interchangeable with RECTUS/LEGRIS 23/24, PARKER 20/30 - 1/4, TEMA 1400, HANSEN 3000, CEJN 310, INDUSTRIAL 1/4, GROMELLE 600 and US-MIL SPEC C-4109.

Product details

- Working Pressure: -0.99 bar [-0.099 MPa] to 15 bar [1.5 MPa]
- Working Temperature: - 20 °C to + 80 °C
- Fluid: Compressed Air

Stock No.	A	B	C	D	CH	Pack
176-1111	1/4	8	41.5	-	17	10

STEEL FEMALE PLUG



RS PRO DN5.5 quick connect couplings according to UNI ISO 6150 B12. Interchangeable with RECTUS/LEGRIS 23/24, PARKER 20/30 - 1/4, TEMA 1400, HANSEN 3000, CEJN 310, INDUSTRIAL 1/4, GROMELLE 600 and US-MIL SPEC C-4109.

Product details

- Working Pressure: -0.99 bar [-0.099 MPa] to 15 bar [1.5 MPa]
- Working Temperature: - 20 °C to + 80 °C
- Fluid: Compressed Air

Stock No.	A	B	C	D	CH	Pack
176-1112	1/4	11	41.5	-	17	10

FEMALE PLUG

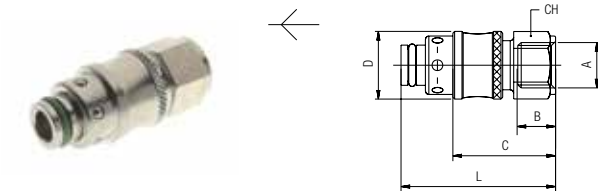

RS PRO DN8 quick connect couplings with FRENCH profile. Interchangeable with DN8 RECTUS 608 / 612.

Product details

- Working Pressure: 0 bar to 15 bar [1.5 MPa]
- Working Temperature: - 15 °C to + 200 °C
- Fluid: Water / Cooling Water / Oil

Stock No.	A	B	C	D	L	CH	Pack
176-1963	1/4	11	30	20	47	17	10

STRAIGHT PLUG WITH REST FOR RUBBER HOSE

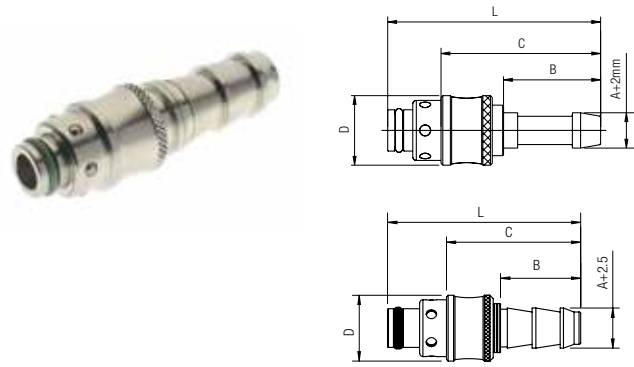

RS PRO DN8 quick connect couplings with FRENCH profile. Interchangeable with DN8 RECTUS 608 / 612.

Product details

- Working Pressure: 0 bar to 15 bar (1.5 MPa)
- Working Temperature: - 15 °C to + 200 °C
- Fluid: Water / Cooling Water / Oil

Stock No.	A	B	C	D	L	Pack
176-1968	3/8	24	48	20	60	10
176-1969	1/2	28	54.5	20	66	10
176-1965	8	27.5	45	20	62.5	10
176-1966	10	27.5	45	20	62.5	10
176-1967	12	33	50.5	20	68	10

PLUG WITH REST FOR RUBBER HOSE TO 90°

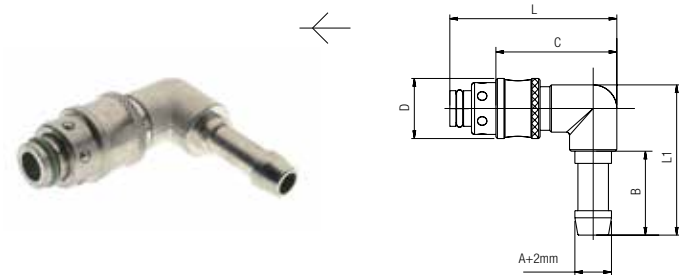

RS PRO DN8 quick connect couplings with FRENCH profile. Interchangeable with DN8 RECTUS 608 / 612.

Product details

- Working Pressure: 0 bar to 15 bar (1.5 MPa)
- Working Temperature: - 15 °C to + 200 °C
- Fluid: Water / Cooling Water / Oil

Stock No.	A	B	C	D	L	L1	Pack
176-1971	8	27.5	39.5	20	57	49	10
176-1972	10	27.5	39.5	20	57	49	10
176-1973	12	33	39.5	20	57	55	10

MALE SOCKET

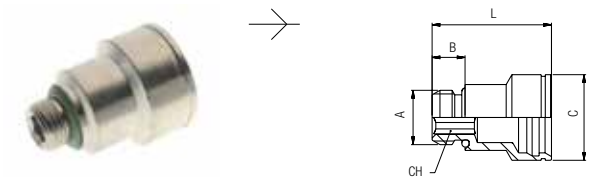

RS PRO DN8 quick connect couplings with FRENCH profile. Interchangeable with DN8 RECTUS 608 / 612.

Product details

- Working Pressure: 0 bar to 15 bar (1.5 MPa)
- Working Temperature: - 15 °C to + 200 °C
- Fluid: Water / Cooling Water / Oil

Stock No.	A	B	C	L	CH	Pack
176-1977	1/8	6	21	27.5	5	10
176-1978	1/4	8	21	29	8	10
176-1979	3/8	9	21	30	10	10

EXTENDED MALE SOCKET

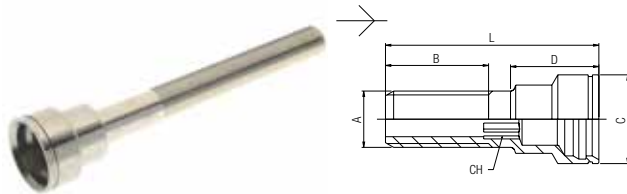

RS PRO DN8 quick connect couplings with FRENCH profile. Interchangeable with DN8 RECTUS 608 / 612.

Product details

- Working Pressure: 0 bar to 15 bar (1.5 MPa)
- Working Temperature: - 15 °C to + 200 °C
- Fluid: Water / Cooling Water / Oil

Stock No.	A	B	C	D	L	CH	Pack
176-1980	1/8	27	21	21	50	5	10
176-1981	1/8	60	21	21	100	5	10
176-1982	1/8	60	21	21	150	5	10
176-1983	1/8	60	21	21	200	5	10
176-1984	1/4	27	21	20	50	8	10
176-1985	1/4	60	21	20	100	8	10
176-1987	1/4	60	21	20	150	8	10
176-1988	1/4	60	21	20	200	8	10
176-1989	3/8	35	21	11	50	10	10
176-1990	3/8	60	21	11	100	10	10
176-1991	3/8	60	21	11	150	10	10
176-1993	3/8	60	21	11	200	10	10

MALE SOCKET TAPER

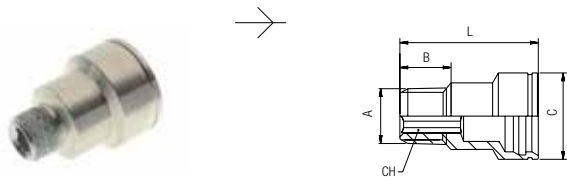

RS PRO DN8 quick connect couplings with FRENCH profile. Interchangeable with DN8 RECTUS 608 / 612.

Product details

- Working Pressure: 0 bar to 15 bar (1.5 MPa)
- Working Temperature: - 15 °C to + 200 °C
- Fluid: Water / Cooling Water / Oil

Stock No.	A	B	C	L	CH	Pack
176-1994	1/8	7.5	21	28	5	10
176-1995	1/4	11	21	31	8	10
176-1996	3/8	11.5	21	31	10	10

FEMALE PLUG

RS PRO DN12 quick connect couplings with FRENCH profile. Interchangeable with DN12 RECTUS 608 / 612.

Product details

- Working Pressure: 0 bar to 15 bar (1.5 MPa)
- Working Temperature: - 15 °C to + 200 °C
- Fluid: Water / Cooling Water / Oil

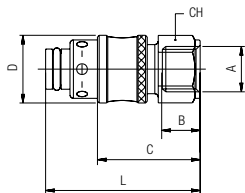

Stock No.	A	B	C	D	L	CH	Pack
176-1974	1/2	15	38.5	28	58	24	10

STRAIGHT PLUG WITH REST FOR RUBBER HOSE

RS PRO DN12 quick connect couplings with FRENCH profile. Interchangeable with DN12 RECTUS 608 / 612.

Product details

- Working Pressure: 0 bar to 15 bar (1.5 MPa)
- Working Temperature: - 15 °C to + 200 °C
- Fluid: Water / Cooling Water / Oil

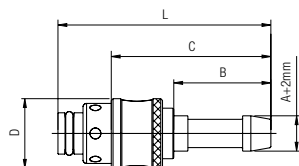

Stock No.	A	B	C	D	L	Pack
176-1975	13	33	55	28	75	10
176-1976	16	33	55	28	75	10

MALE SOCKET

RS PRO DN12 quick connect couplings with FRENCH profile. Interchangeable with DN12 RECTUS 608 / 612.

Product details

- Working Pressure: 0 bar to 15 bar (1.5 MPa)
- Working Temperature: - 15 °C to + 200 °C
- Fluid: Water / Cooling Water / Oil

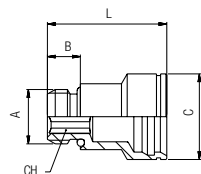

Stock No.	A	B	C	L	CH	Pack
176-1997	3/8	9	32	37.5	10	10
176-1998	1/2	10	32	38	12	10

Blow Guns

Designed for effective industrial drying and cleaning, RS PRO blow gun nozzles deliver a jet of compressed air wherever it is needed. Precise control of the blow gun is enabled with the thumb lever.

Features

Component Parts and Materials

- Nickel-plated brass back connection
- Nickel-plated brass hand/ferro plastified
- Nickel-plated brass central body
- Nickel-plated brass front body
- Nickel-plated brass locking nut
- Nickel-plated inox nozzle
- Yellow brass clamping olive
- NBR 70 O-RING seals steel pin
- Nickel-plated brass plunger
- Steel AISI 302 plunger thrust spring
- NBR 70 O-RING seals
- NBR 70 O-RING seals
- Steel AISI 302 plunger back spring

BLOWGUN WITH Ø6 mm BENT PIPE WITH METAL BUSHING

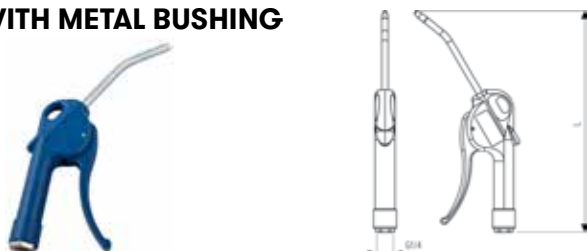

Stock No.	L	Pack
176-2230	217	1

VENTURI EFFECT NOZZLE (SPARE PART)

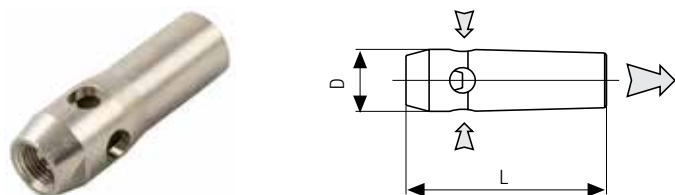

Stock No.	L	D	Pack
176-2229	55	14	1

STRAIGHT NOZZLE (SPARE PART)

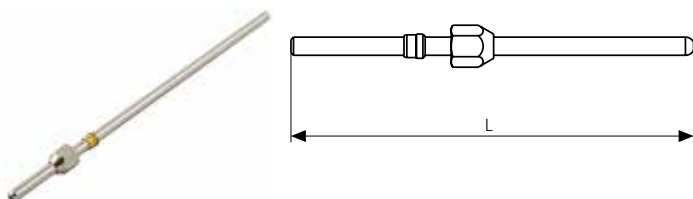

Stock No.	L	Pack
176-2228	300	1

Nickel-Plated Brass Adaptors

RS PRO has available a large range of nickel-plated brass adaptors in countless configurations and multiple sizes. All offer high pressure performance and operation to temperatures of +300°C.

We offer nipples, reducers, plugs, extensions, hose adaptors and tee, Y and elbow connectors.

Features

Main advantages

- Complete range M5 - 1"
- Compatible with all fluids
- Mechanically resistant
- Standard and bayonet connection
- Silicon free

Applications

- Compressed air
- Pneumatic automation
- Industrial water circuits
- Inert Gases, fluids, Steam
- Vacuum

NIPPLE (TAPER)

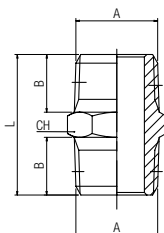

Stock No.	A	B	L	CH	Pack
176-0978	1/8	7.5	19.5	12	10
176-0980	3/8	11.5	28	17	10
176-0981	1/2	14	33.5	22	10
176-0979	1/4	11	27	14	10
176-0982	3/4	16.5	40	27	10
176-0984	1"	19	46.5	34	10

NIPPLE (PARALLEL)

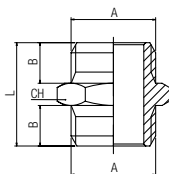

Stock No.	A	B	L	CH	Pack
176-0985	1/8	6	16.5	14	10
176-0986	1/4	8	21	17	10
176-0987	3/8	9	23	19	10
176-0988	1/2	10	25.5	24	10
176-2133	M5	4	11.5	8	10

REDUCING NIPPLE (TAPER)

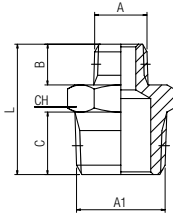

Stock No.	A	A1	B	C	L	CH	Pack
176-0995	1/8	1/4	7.5	11	23.5	14	10
176-0989	1/8	3/8	7.5	11.5	24	17	10
176-0990	1/4	3/8	11	11.5	27.5	17	10
176-0991	1/4	1/2	11	14	30.5	22	10
176-0992	3/8	1/2	11.5	14	31	22	10
176-0993	1/2	3/4	14	16.5	37.5	27	10
176-0994	3/4	1"	16.5	19	44	34	10

REDUCER (PARALLEL)

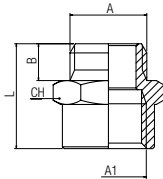

Stock No.	A	A1	B	L	CH	Pack
176-0996	1/8	1/8	6	17	14	10
176-1004	1/8	1/4	6	20.5	17	10
176-0997	1/8	3/8	6	21.5	22	10
176-0998	1/4	1/4	8	22.5	17	10
176-1000	1/4	3/8	8	23.5	22	10
176-1001	1/4	1/2	8	26.5	26	10
176-1002	3/8	3/8	9	24.5	22	10
176-1003	3/8	1/2	9	27.5	26	10
176-2134	M5	1/8	4	14.5	14	10

EXTENSION (PARALLEL)

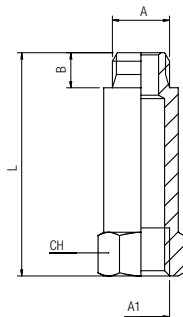

Stock No.	A	A1	L	B	CH	Pack
176-1005	1/8	1/8	22	6	14	10
176-1008	1/8	1/8	32	6	14	10
176-1006	1/4	1/4	35	8	17	10
176-1007	1/4	1/4	51	8	17	10

REDUCER (TAPER)

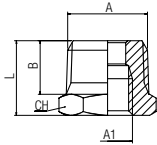

Stock No.	A	A1	B	L	CH	Pack
176-1010	1/4	1/8	11	16	14	10
176-1011	3/8	1/8	11.5	16.5	17	10
176-1012	3/8	1/4	11.5	16.5	17	10
176-1013	1/2	1/4	14	19.5	22	10
176-1014	1/2	3/8	14	19.5	22	10
176-1016	3/4	3/8	16.5	23.5	27	10
176-1017	3/4	1/2	16.5	23.5	27	10

REDUCER (PARALLEL) WITH NBR O-RING

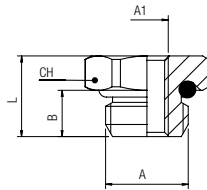

Stock No.	A	A1	B	L	CH	R	C	Pack
176-1018	1/8	M5	5,4	9,4	13	8	3	10
176-1026	1/4	M5	7	11	16	20	6	10
176-1019	1/4	1/8	5,5	11,1	16	20	6	10
176-1020	3/8	1/8	6,5	12,6	20	70	10	10
176-1022	3/8	1/4	6,5	12,6	20	40	9	10
176-1027	1/2	1/8	9,5	14,5	25	130	12	10
176-1023	1/2	1/4	9,6	14,6	25	130	12	10
176-1024	1/2	3/8	9,6	14,6	25	110	12	10
176-1028	3/4	1/4	11	16	34	130	12	10
176-1029	3/4	3/8	11	16	34	130	12	10
176-1025	3/4	1/2	11,1	16	34	110	12	10

MALE ORIENTING NIPPLE WITH OR (PARALLEL)

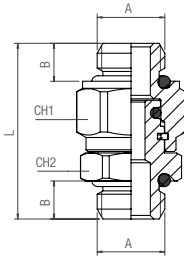

Stock No.	A	B	L	CH1	CH2	Pack
176-1030	1/8	5,5	25	14	13	10
176-1031	1/4	7	29	17	16	10
176-1032	3/8	8	33	20	20	10
176-1033	1/2	9,5	37	25	25	10
176-1034	3/4	11	48,5	34	34	10

SLEEVE

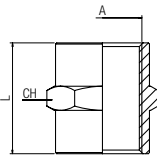

Stock No.	A	L	CH	Pack
176-1035	1/8	15	14	10
176-1036	1/4	22	17	10
176-1038	3/8	24	22	10
176-1039	1/2	30	26	10
176-2135	M5	11	8	10
176-1040	3/4	32	32	10

REDUCING SLEEVE

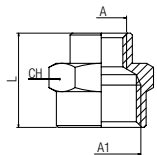

Stock No.	A	A1	L	CH	Pack
176-1047	1/8	1/4	19	17	10
176-1041	1/8	3/8	20	22	10
176-1042	1/4	3/8	23	22	10
176-1044	1/4	1/2	25	24	10
176-1045	3/8	1/2	27,5	24	10
176-1046	1/2	3/4	30	30	10
176-2136	M5	1/8	13	14	10

MALE PLUG (PARALLEL) WITH HEXAGON EMBEDDED AND NBR O-RING

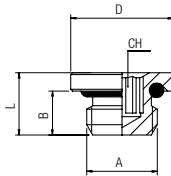

Stock No.	A	B	L	D	CH	Pack
176-1048	1/8	6	8.5	14	5	10
176-1049	1/4	8	11	17	6	10
176-1050	3/8	9	12.5	20	8	10
176-1051	1/2	10	13.5	25	10	10
176-2137	M5	4	6	8	2	10

MALE PLUG (PARALLEL)

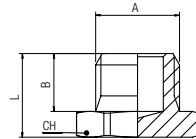

Stock No.	A	B	L	CH	Pack
176-1052	1/8	6.5	10	14	10
176-1053	1/4	9	13	17	10

MALE PLUG (TAPER)

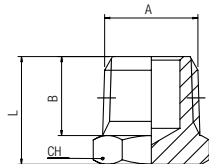

Stock No.	A	B	L	CH	Pack
176-1052	1/4	11	15	14	10
176-1053	3/8	11,5	15,5	17	10

MALE PLUG (TAPER)

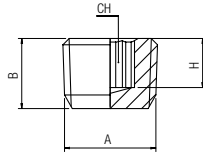

Stock No.	A	B	H	CH	Pack
176-1054	1/8	7.5	5	5	10
176-1055	1/4	10	7	6	10
176-1056	3/8	11	7	8	10
176-1057	1/2	13	8	10	10

MALE HOSE ADAPTER (TAPER)

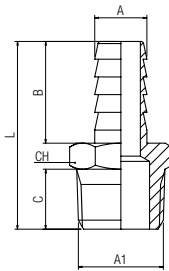

Stock No.	A	A1	B	C	L	CH	Pack
176-2014	4	1/8	19.5	7.5	32	12	10
176-2015	6	1/8	19.5	7.5	32	12	10
176-2017	7	1/8	19.5	7.5	32	12	10
176-2016	7	1/4	19.5	11	35.5	14	10
176-2020	10	1/8	19.5	7.5	32	12	10
176-2021	10	1/4	19.5	11	35.5	14	10
176-2022	10	3/8	19.5	11.5	36	17	10
176-2023	12	3/8	19.5	11.5	36	17	10
176-2025	16	3/8	19.5	11.5	36	17	10
176-2026	16	1/2	19.5	14	39	22	10
176-2027	16	3/4	19.5	16.5	43.5	27	10
176-2028	18	3/8	19.5	11.5	36	19	10
176-2030	18	1/2	19.5	14	39	22	10
176-2029	18	3/4	19.5	16.5	43.5	27	10
176-2019	25	3/4	30	14.5	51.5	27	10
176-2031	25	1"	30	16	53.5	34	10

MALE HOSE ADAPTER (PARALLEL) WITH O-RING

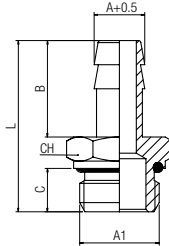

Stock No.	A	A1	B	C	L	CH	Pack
176-2038	6	1/4	20	8	34.5	16	10
176-2032	7	1/4	20	8	34.5	16	10
176-2033	8	1/8	20	6	31	13	10
176-2034	8	1/4	20	8	34.5	16	10
176-2039	8	3/8	20	9	35.5	19	10
176-2040	10	1/4	20	8	34.5	16	10
176-2041	10	3/8	24	9	39.5	19	10
176-2042	10	1/2	22	10	39.5	24	10
176-2035	12	1/4	20	8	34.5	16	10
176-2037	13	1/2	22	10	39.5	24	10
176-2036	17	1/2	24	10	41.5	24	10

BULKHEAD CONNECTOR

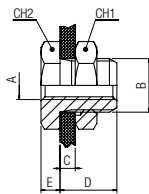

Stock No.	A	B	C max	D	E	CH1	CH2	Pack
176-2044	1/8	M16×1.5	10	14	4	22	19	10
176-2045	1/4	M20×1.5	16	21	4	27	24	10
176-2046	3/8	M26×1.5	15	21	5	32	30	10
176-2043	M5	M10×1	7	10.5	3.5	14	14	10

FEMALE TEE

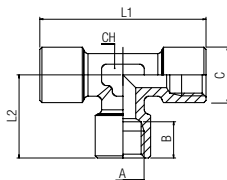

Stock No.	A	B	L2	L1	C	CH	Pack
176-1058	1/8	8.5	19.5	39	13	12	10
176-1060	1/4	11	24.5	49	16.5	13	10
176-1061	3/8	12	27	54	20.5	16	10
176-1062	1/2	15	32	64	25.5	20	10
176-1063	3/4	16.5	36.5	73	32.5	27	10

CENTRE LEG MALE TEE

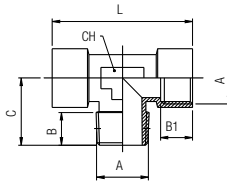

Stock No.	A	B	B1	C	L	CH	Pack
176-1064	1/8	8	8.5	17.5	39	12	10
176-1066	1/4	11	11	23	49	13	10
176-1067	3/8	11.5	12	25.5	54	16	10
176-1068	1/2	14	15	29.5	64	20	10
176-1069	3/4	14.5	16.5	32	73	27	10
176-1070	1"	16.8	19	39	90	30	5

OFF SET MALE TEE

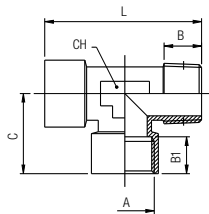

Stock No.	A	B	B1	C	L	CH	Pack
176-1071	1/8	8	8.5	19.5	37	12	10
176-1072	1/4	11	11	24.5	47.5	13	10
176-1073	3/8	11.5	12	27	52.5	16	10
176-1074	1/2	14	15	32	61.5	20	10

MALE ELBOW

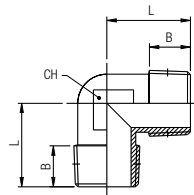

Stock No.	A	B	L	CH	Pack
176-1075	1/8	7.5	18	11	10
176-1076	1/4	11	24	13	10
176-1077	3/8	12	27	17	10
176-1078	1/2	14	29.5	20	10

FEMALE ELBOW

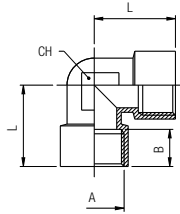

Stock No.	A	B	L	CH	Pack
176-1079	1/8	8.5	21	11	10
176-1080	1/4	11	25.5	13	10
176-1081	3/8	11.5	28	17	10
176-1082	1/2	15	32	20	10
176-1083	3/4	16.5	36.5	27	10

MALE-FEMALE ELBOW

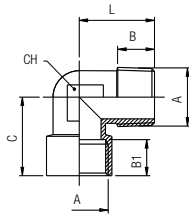

Stock No.	A	B	B1	C	L	CH	Pack
176-1084	1/8	7.5	8.5	21	18	11	10
176-1085	1/4	11	11	25.5	24	13	10
176-1086	3/8	11.5	12	28	27	17	10
176-1088	1/2	14	15	32	29.5	20	10
176-1089	3/4	14.5	16.5	36.5	32	27	10

CENTRAL MALE Y 90°

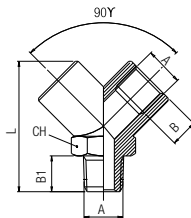

Stock No.	A	B	B1	L	CH	Pack
176-1090	1/4	11	11	37	17	10
176-1091	3/8	11.5	12.5	46	22	10
176-1092	1/2	14	16.5	58	26	10

FEMALE Y 90°

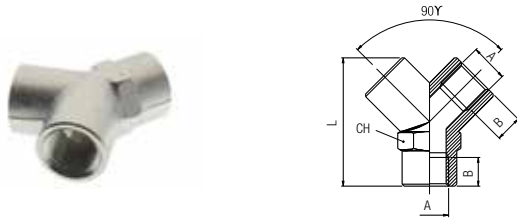

Stock No.	A	B	L	CH	Pack
176-1094	1/8	8.5	33	14	10
176-1095	1/4	11	37	17	10
176-1096	3/8	11.5	46	22	10
176-1097	1/2	14	58	26	10

ALUMINIUM TEE CROSS

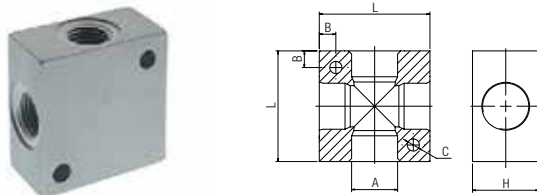

Stock No.	A	L	H	B	C	Pack
176-1098	1/4	40	20	6.5	5.5	10
176-1099	3/8	50	25	7.5	5.5	5
176-1101	1/2	50	30	7.5	5.5	5

ALUMINIUM DISTRIBUTION MANIFOLD

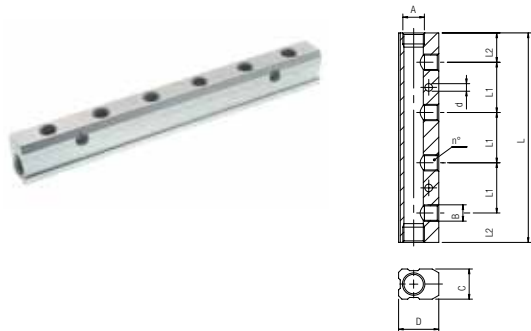

Stock No.	A	B	n°	C	D	L1	L2	L	d	Pack
176-1102	3/8	1/4	3	22	30	36	20	112	5.5	5
176-1103	3/8	1/4	4	22	30	36	20	148	5.5	5
176-1104	3/8	1/4	6	22	30	36	20	220	5.5	5

ADAPTER FEMALE BSP - MALE NPTF

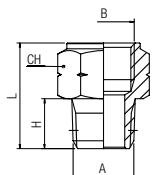

Stock No.	A NPTF	B G	H	L	CH	Pack
176-1113	1/8	1/8	8.5	19.5	14	10
176-1114	1/4	1/4	13	27	17	10
176-1115	3/8	3/8	13	28	22	10

ADAPTER FEMALE NPTF - MALE G THREAD

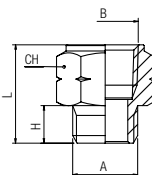

Stock No.	A G	B NPTF	H	L	CH	Pack
176-1117	1/8	1/8	6	17	14	10
176-1118	1/4	1/4	8	23	17	10
176-1119	3/8	3/8	9	24	22	10
176-1120	1/2	1/2	12	31.5	27	10

SILENCER

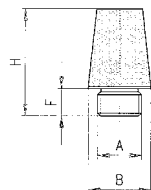

Stock No.	A	F	B	H	dB*	Pack
176-2273	1/8	4.5	12.5	21	81	10
176-2274	1/4	6	15	25	83	10
176-2275	3/8	8.5	19	34.5	87	10
176-2277	1/2	8	23	43	90	10
176-2278	3/4	9	30	50	92 @ 4 Bar	10

SILENCER

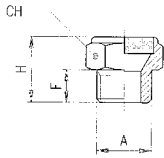

Stock No.	A	F	H	CH	dB*	Pack
176-2279	1/8	6	14	13	73	10
176-2280	1/4	7	17	16	74	10
176-2281	3/8	8	18	19	85	10
176-2282	1/2	10	20	24	89	10

SILENCER

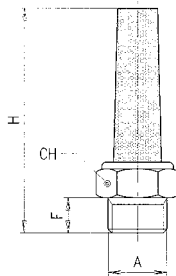

Stock No.	A	F	H	CH	dB*	Pack
176-2283	1/8	6	44	13	76	10
176-2284	1/4	7	50	16	75	10
176-2285	3/8	8	54	19	88	10
176-2286	1/2	9	67	24	89	10

POROUS POLYETHYLENE SILENCER

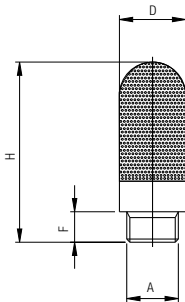

Stock No.	A	F	H	D	Pack
176-2288	1/8	6	34	12.5	10
176-2289	1/4	7	42.5	15.5	10
176-2290	3/8	11.5	67.5	18.5	10
176-2291	1/2	11	78	23.5	10
176-2287	M5	4	23	6.5	10

Ball Valves

Our RS PRO ball valve range with chrome nickel-plated brass body have been created and engineered to give excellent performance in the field. It is this performance and their compact dimensions that provide a solution to the growing demand of miniaturisation.

Features

Main advantages

- 2-3 ways with exhaust
- Threads 1/8 to 3/8
- Suitable for multiple fluids
- Supercompact dimension
- Coloured plates for Identification
- Silicon free

Applications

- Compressed air, tools
- Pneumatic automation
- Fluid technology
- Food & beverage
- Life & sciences
- Inert gases, vacuum
- Plumbing

FEMALE RP ISO 7 - FEMALE RP ISO 7 VALVE

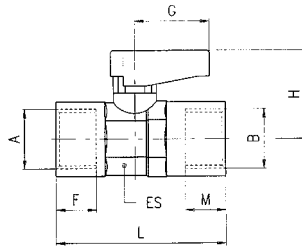

Stock No.	A	B	DN	ES	F	M	L	G	H	Pack
176-2138	1/8	1/8	6	14-15	7.4	7.4	36	19	21	10
176-2139	1/4	1/4	6	14-15	11	11	43	19	21	10
176-2140	3/8	3/8	8	18-19	11.4	11.4	47	19	22	10

TAPER MALE R ISO 7 - FEMALE RP ISO 7 VALVE

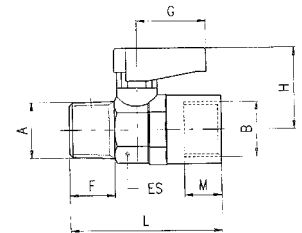

Stock No.	A	B	DN	ES	F	M	L	G	H	Pack
176-2141	1/8	1/8	6	14-15	7.4	7.4	36	19	21	10
176-2142	1/4	1/4	6	14-15	11	11	43	19	21	10
176-2143	3/8	3/8	8	18-19	11.4	11.4	46	19	22	10

Solenoid Pilot Valves

The solenoid pilot valve range is robust, versatile and combines high performances with compact installation dimensions.

Offering large flow capacity, short change-over times and low change-over pressure, the RS PRO range is solenoid, electrical, mechanical or manually operated. They can withstand up to 10 bar working pressure.

Features

Main advantages

- Extremely durable
- High flow in a compact dimension
- Easy installation
- Large range
- Energy saving

Applications

- Pneumatic automation, robotics, handling
- Automotive process
- Textile, packaging,
- Food processing
- ATEX zone

3/2 Ways - MONOSTABLE SPRING RETURN

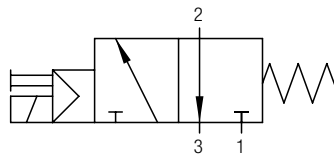

NC

Stock No.	Ways	Function	Size	Pack
176-2112	3/2	NC	1/8	1
176-2113	3/2	NC	1/4	1
176-2114	3/2	NC	1/2	1

5/2 Ways - MONOSTABLE SPRING RETURN

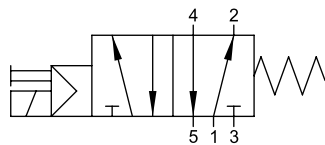

Stock No.	Ways	Size	Pack
176-2115	5/2	1/8	1
176-2132	5/2	1/4	1
176-2117	5/2	1/2	1

5/2 Ways - TWO STABLE POSITIONS

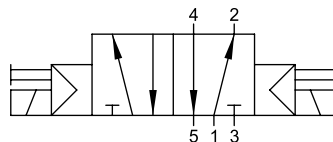

Stock No.	Ways	Size	Pack
176-2125	5/2	1/8	1
176-2126	5/2	1/4	1
176-2127	5/2	1/2	1

5/3 Ways - MONOSTABLE SPRING RETURN

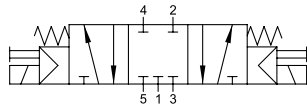

CC

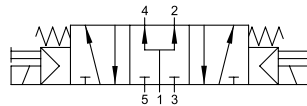

PC

Stock No.	Ways	Function	Size	Pack
176-2102	5/3	CC	1/8	1
176-2120	5/3	CC	1/4	1
176-2121	5/3	CC	1/2	1
176-2122	5/3	PC	1/8	1
176-2123	5/3	PC	1/4	1
176-2124	5/3	PC	1/2	1

3/2 Ways - MONOSTABLE SPRING RETURN

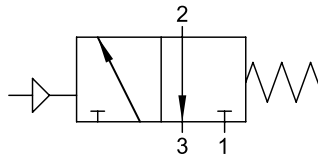

Stock No.	Ways	Size	Pack
176-2116	3/2	1/8	1
176-2104	3/2	1/4	1
176-2105	3/2	1/2	1

5/2 Ways - MONOSTABLE SPRING RETURN

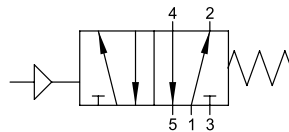

Stock No.	Ways	Size	Pack
176-2106	5/2	1/8	1
176-2107	5/2	1/4	1
176-2108	5/2	1/2	1

5/2 Ways - TWO STABLE POSITIONS

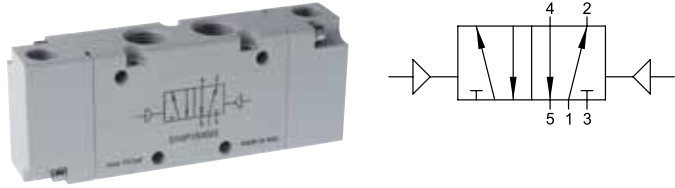

Stock No.	Ways	Size	Pack
176-2109	5/2	1/8	1
176-2110	5/2	1/4	1
176-2111	5/2	1/2	1

SOLENOID 22MM

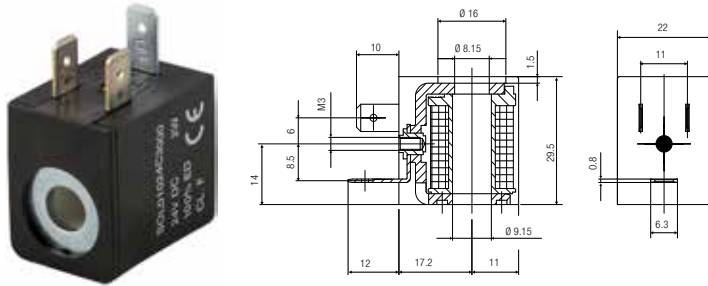

Stock No.	Voltage	Power	Pack
176-2128	12V DC	3W	1
176-2129	24V DC	3W	1
176-2130	24V AC	5VA	1
176-2131	110V AC	5VA	1
176-2118	220V AC	5VA	1

CONNECTOR 22MM

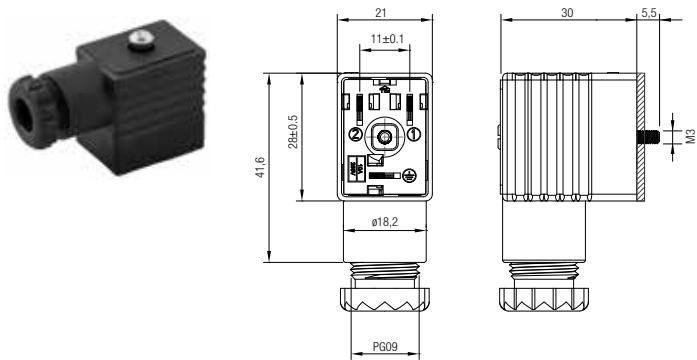

Stock No.	Colour	Pins	Pack
176-2066	Black	2	1

Fluid Solenoid Valves

RS PRO offers a range of direct acting and indirect acting solenoid valves in a choice of fittings, thread sizes and specifications. Normally open and normally closed options are available.

Construction includes brass or stainless steel armature tube and stainless steel core. Solenoids, available separately, also form part of the range.

Features

Main advantages

- Body: brass
- Seals: NBR - EPDM - FKM
- Welded armature tube: brass or stainless steel
- Fixed and mobile core: stainless steel
- Springs: stainless steel

2/2 NC - DIRECT ACTING SOLENOID VALVES

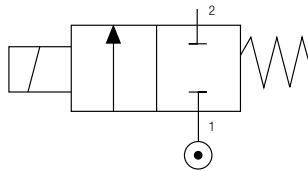

Stock No.	Seals	Thread Size	Ø mm	Viscosity	Kv m3/h	Power		ΔP bar	
						DC	AC	Min	Max
176-2060	NBR	1/8"	1,5	25	0.06	6,5	-	0	21.1
176-2050	NBR	1/4"	2.5	53	0.15	6,5	-	0	3.7
176-2051	FKM	1/4"	2.5	53	0.15	-	7,5	0	11

2/2 NO - DIRECT ACTING SOLENOID VALVES

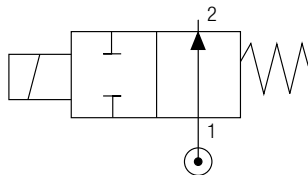

Stock No.	Seals	Thread Size	Ø mm	Viscosity	Kv m3/h	Power		ΔP bar	
						DC	AC	Min	Max
176-2048	NBR	1/8"	2	37	0.09	6,5	-	0	11
176-2049	FKM	1/8"	2	37	0.09	-	7,5	0	28.7
176-2052	NBR	1/4"	2	37	0.09	8	-	0	9.5
176-2053	FKM	1/4"	2	37	0.09	-	7,5	0	9.5

2/2 NC - DIRECT ACTING SOLENOID VALVES

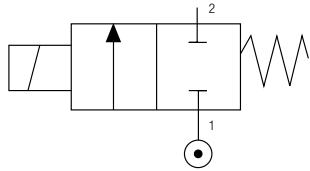

Stock No.	Seals	Thread Size	Ø mm	Viscosity	Kv m3/h	Power		ΔP bar	
						DC	AC	Min	Max
176-2054	NBR	1/4"	3	53	0.21	8	-	0	11.4
176-2055	FKM	1/4"	3	53	0.21	-	14	0	40
176-2056	NBR	1/4"	4	53	0.35	8	-	0	4
176-2057	FKM	1/4"	4	53	0.35	-	14	0	15

2/2 NC - INDIRECT ACTING SOLENOID VALVES

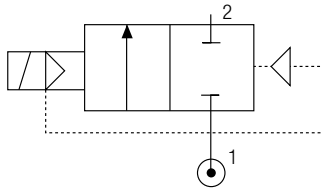

Stock No.	Seals	Thread Size	Ø mm	Viscosity	Kv m3/h	Power		ΔP bar	
						DC	AC	Min	Max
176-2058	NBR	1/2"	12	25	3.03	6.5	-	0.15	11.2
176-2059	FKM	1/2"	12	25	3.03	-	7.5	0.15	13.8

2/2 NO - INDIRECT ACTING SOLENOID VALVES

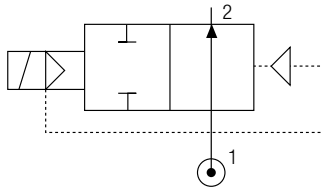

Stock No.	Seals	Thread Size	Ø mm	Viscosity	Kv m3/h	Power		ΔP bar	
						DC	AC	Min	Max
176-2076	NBR	1/2"	12	25	3.03	6.5	-	0.15	9.5
176-2061	FKM	1/2"	12	25	3.03	-	7.5	0.15	9.5

2/2 NC - INDIRECT ACTING SOLENOID VALVES

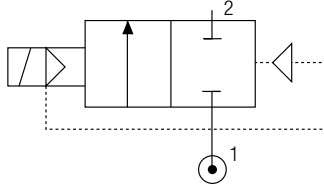

Stock No.	Seals	Thread Size	Ø mm	Viscosity	Kv m3/h	Power		ΔP bar	
						DC	AC	Min	Max
176-2047	NBR	3/4"	18	25	5.56	6.5	-	0.15	11.2
176-2063	FKM	3/4"	18	25	5.56	-	7.5	0.15	13.8
176-2064	NBR	1"	25	25	10.97	6.5	-	0.15	11.2
176-2065	FKM	1"	25	25	10.97	-	7.5	0.15	13.8

SOLENOIDS

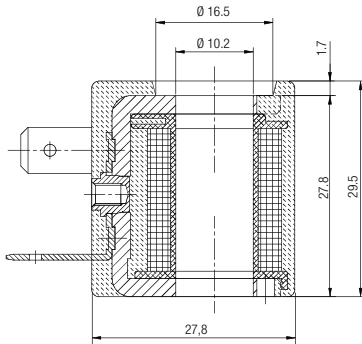

Stock No.	Operator diameter	Size	Voltage		Function
			DC	AC	
176-2069	10	22	24	48	6.5
176-2073	10	30	24	48	8
176-2068	10	22	24	-	7.5
176-2070	10	22	110	-	7.5
176-2071	10	22	220	110	7.5
176-2072	10	30	24	-	11
176-2075	10	30	110	-	11
176-2062	10	30	220	110	11

CONNECTOR

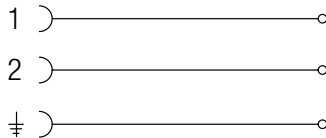

Stock No.	Colour	Pins	Size
176-2067	Black	2	30-36

Magnetic Switches

Our magnetic switches consist of RS PRO magnetic reed switch with either 2-core or 3-core PVC cable for use with pneumatic cylinders.

MAGNETIC SWITCHES



Stock No.	Connection - Wires	Sensor type	Voltage Range	Max current at 25°C	Max power/ Resistive load	Max voltage drop	Response time
176-1580	2 WIRE PVC - 2,5 MT	REED	3-130 V AC/DC	50 mA	10 W	3.2	0.5 ms max
176-1618	3 WIRE PVC - 2,5 MT	PNP - HALL	10-30 V DC	200 mA	6 W	0.8	0.2 ms max

BRACKET FOR DSL TO USE WITH MINI-CYLINDERS



Stock No.	Ø	F = Ø	A	B
176-1625	16	17.3 mm	14	8
176-1624	20	21.3 mm	14	8
176-1623	25	26.3 mm	14	8

Compact Cylinders

The compact cylinder range from RS PRO is robust, versatile and combines high performances with compact installation dimensions. Construction consists of chrome steel piston rod and polyurethane rod and piston seal.

The range covers bore diameters to 100mm.

Features

- Main advantages**
- NBR O-ring seals
 - Sintered bronze bearing
 - Zinc-plated steel screw
 - Anodised aluminium cylinder body
 - Bonded ferrite magnet

DOUBLE ACTING MAGNETIC Bore from 32 to 100

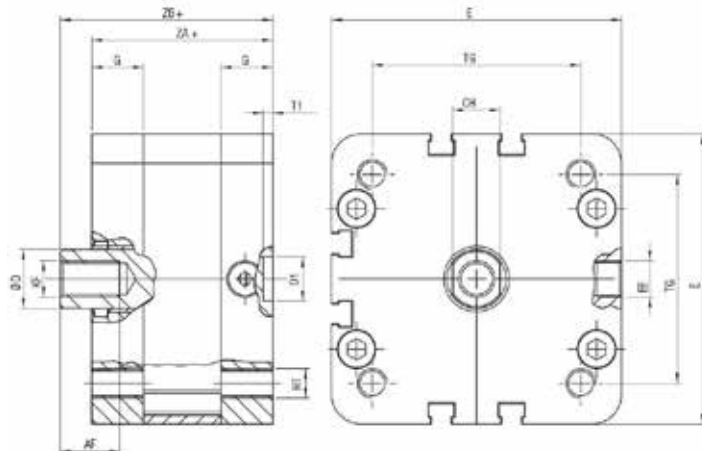

Stock No.	Ø	Stroke	Ø D	E	A	KK	CH	AF	KF	RT	G	TG	EE	PL	ØD1	T1	ZA+	ZB+
176-1587	32	25	12	49	19	M10X1,25	10	12	M8	M6	14,5	32,5	G1/8	7.5	9	2,1	44	51
176-1586	32	50	12	49	19	M10X1,25	10	12	M8	M6	14,5	32,5	G1/8	7.5	9	2,1	44	51
176-1585	32	80	12	49	19	M10X1,25	10	12	M8	M6	14,5	32,5	G1/8	7.5	9	2,1	44	51
176-1584	32	100	12	49	19	M10X1,25	10	12	M8	M6	14,5	32,5	G1/8	7.5	9	2,1	44	51
176-1583	32	125	12	49	19	M10X1,25	10	12	M8	M6	14,5	32,5	G1/8	7.5	9	2,1	44	51
176-1581	40	25	12	55	19	M10X1,25	10	12	M8	M6	15	38	G1/8	7.5	9	2,1	45	52
176-1656	40	50	12	55	19	M10X1,25	10	12	M8	M6	15	38	G1/8	7.5	9	2,1	45	52
176-1577	40	80	12	55	19	M10X1,25	10	12	M8	M6	15	38	G1/8	7.5	9	2,1	45	52
176-1638	40	100	12	55	19	M10X1,25	10	12	M8	M6	15	38	G1/8	7.5	9	2,1	45	52
176-1693	40	125	12	55	19	M10X1,25	10	12	M8	M6	15	38	G1/8	7.5	9	2,1	45	52
176-1692	50	25	16	68	22	M12X1,25	13	16	M10	M8	14,5	46,5	G1/8	7.5	12	2,6	45	53
176-1691	50	50	16	68	22	M12X1,25	13	16	M10	M8	14,5	46,5	G1/8	7.5	12	2,6	45	53
176-1690	50	80	16	68	22	M12X1,25	13	16	M10	M8	14,5	46,5	G1/8	7.5	12	2,6	45	53
176-1689	50	100	16	68	22	M12X1,25	13	16	M10	M8	14,5	46,5	G1/8	7.5	12	2,6	45	53
176-1688	50	125	16	68	22	M12X1,25	13	16	M10	M8	14,5	46,5	G1/8	7.5	12	2,6	45	53
176-1687	50	200	16	68	22	M12X1,25	13	16	M10	M8	14,5	46,5	G1/8	7.5	12	2,6	45	53
176-1677	63	25	16	78,5	22	M12X1,25	13	16	M10	M8	14	56,5	G1/8	7.5	12	2,6	49	57,5
176-1685	63	50	16	78,5	22	M12X1,25	13	16	M10	M8	14	56,5	G1/8	7.5	12	2,6	49	57,5

DOUBLE ACTING MAGNETIC
Bore from 32 to 100

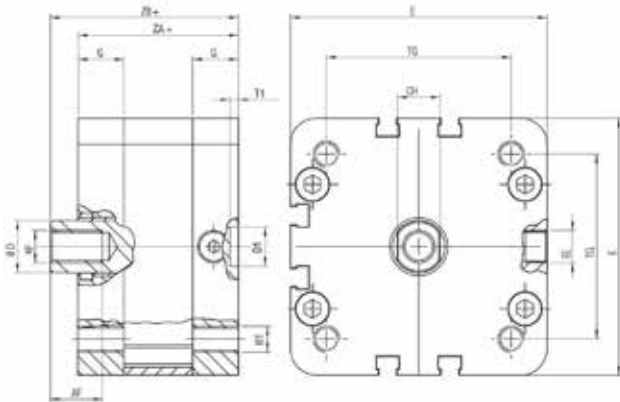

Stock No.	Ø	Stroke	Ø D	E	A	KK	CH	AF	KF	RT	G	TG	EE	PL	ØD1	T1	ZA+	ZB+
176-1694	63	80	16	78,5	22	M12X1,25	13	16	M10	M8	14	56,5	G1/8	7,5	12	2,6	49	57,5
176-1683	63	100	16	78,5	22	M12X1,25	13	16	M10	M8	14	56,5	G1/8	7,5	12	2,6	49	57,5
176-1682	63	125	16	78,5	22	M12X1,25	13	16	M10	M8	14	56,5	G1/8	7,5	12	2,6	49	57,5
176-1681	63	200	16	78,5	22	M12X1,25	13	16	M10	M8	14	56,5	G1/8	7,5	12	2,6	49	57,5
176-1680	80	25	20	98	28	M16X1,5	17	20	M12	M10	15,5	72	G1/8	7,5	12	2,6	54	64
176-1679	80	50	20	98	28	M16X1,5	17	20	M12	M10	15,5	72	G1/8	7,5	12	2,6	54	64
176-1678	80	80	20	98	28	M16X1,5	17	20	M12	M10	15,5	72	G1/8	7,5	12	2,6	54	64
176-1703	80	100	20	98	28	M16X1,5	17	20	M12	M10	15,5	72	G1/8	7,5	12	2,6	54	64
176-1705	80	125	20	98	28	M16X1,5	17	20	M12	M10	15,5	72	G1/8	7,5	12	2,6	54	64
176-1686	80	200	20	98	28	M16X1,5	17	20	M12	M10	15,5	72	G1/8	7,5	12	2,6	54	64
176-1711	100	25	25	120	28	M16X1,5	22	20	M12	M10	20	89	G1/8	7,5	12	2,6	67	77
176-1710	100	50	25	120	28	M16X1,5	22	20	M12	M10	20	89	G1/8	7,5	12	2,6	67	77
176-1709	100	80	25	120	28	M16X1,5	22	20	M12	M10	20	89	G1/8	7,5	12	2,6	67	77
176-1708	100	100	25	120	28	M16X1,5	22	20	M12	M10	20	89	G1/8	7,5	12	2,6	67	77
176-1707	100	125	25	120	28	M16X1,5	22	20	M12	M10	20	89	G1/8	7,5	12	2,6	67	77
176-1706	100	200	25	120	28	M16X1,5	22	20	M12	M10	20	89	G1/8	7,5	12	2,6	67	77

DOUBLE ACTING CUSHIONED MAGNETIC

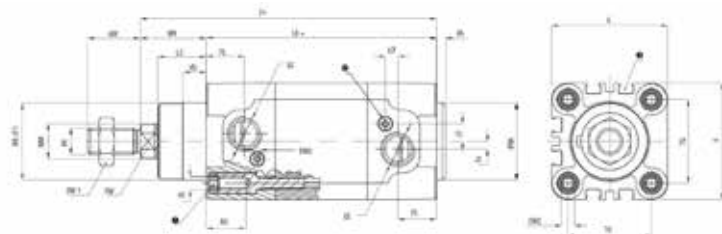

Stock No.	Ø	Stroke	ØB d11	VD	VA	L2	WH	Ø MM	SW	KK	AM	SW1	Z	L8	BG	RT	SW2	E	TG	EE	PL	J3	J2	L7	SW3
176-1695	32	25	30	10	4	20	26	12	10	M10X1,25	22	17	120	94	18	M6	6	46	32,5	G 1/8	18	4	6,5	2	2,5
176-1704	32	50	30	10	4	20	26	12	10	M10X1,25	22	17	120	94	18	M6	6	46	32,5	G 1/8	18	4	6,5	2	2,5
176-1714	32	80	30	10	4	20	26	12	10	M10X1,25	22	17	120	94	18	M6	6	46	32,5	G 1/8	18	4	6,5	2	2,5
176-1702	32	100	30	10	4	20	26	12	10	M10X1,25	22	17	120	94	18	M6	6	46	32,5	G 1/8	18	4	6,5	2	2,5
176-1701	32	125	30	10	4	20	26	12	10	M10X1,25	22	17	120	94	18	M6	6	46	32,5	G 1/8	18	4	6,5	2	2,5
176-1700	32	160	30	10	4	20	26	12	10	M10X1,25	22	17	120	94	18	M6	6	46	32,5	G 1/8	18	4	6,5	2	2,5
176-1699	32	200	30	10	4	20	26	12	10	M10X1,25	22	17	120	94	18	M6	6	46	32,5	G 1/8	18	4	6,5	2	2,5
176-1698	32	250	30	10	4	20	26	12	10	M10X1,25	22	17	120	94	18	M6	6	46	32,5	G 1/8	18	4	6,5	2	2,5
176-1697	40	25	35	10.5	4	22	30	16	13	M12X1,25	24	19	135	105	18	M6	6	54	38	G 1/4	17,5	3,5	8	5,8	2,5
176-1696	40	50	35	10.5	4	22	30	16	13	M12X1,25	24	19	135	105	18	M6	6	54	38	G 1/4	17,5	3,5	8	5,8	2,5
176-1675	40	80	35	10.5	4	22	30	16	13	M12X1,25	24	19	135	105	18	M6	6	54	38	G 1/4	17,5	3,5	8	5,8	2,5
176-1647	40	100	35	10.5	4	22	30	16	13	M12X1,25	24	19	135	105	18	M6	6	54	38	G 1/4	17,5	3,5	8	5,8	2,5
176-1684	40	125	35	10.5	4	22	30	16	13	M12X1,25	24	19	135	105	18	M6	6	54	38	G 1/4	17,5	3,5	8	5,8	2,5
176-1655	40	160	35	10.5	4	22	30	16	13	M12X1,25	24	19	135	105	18	M6	6	54	38	G 1/4	17,5	3,5	8	5,8	2,5
176-1654	40	200	35	10.5	4	22	30	16	13	M12X1,25	24	19	135	105	18	M6	6	54	38	G 1/4	17,5	3,5	8	5,8	2,5
176-1653	40	250	35	10.5	4	22	30	16	13	M12X1,25	24	19	135	105	18	M6	6	54	38	G 1/4	17,5	3,5	8	5,8	2,5
176-1652	50	25	40	11.5	4	28	37	20	17	M16X1,5	32	22	143	106	20	M8	8	64	46,5	G 1/4	20,5	7	10	2	4
176-1651	50	50	40	11.5	4	28	37	20	17	M16X1,5	32	22	143	106	20	M8	8	64	46,5	G 1/4	20,5	7	10	2	4
176-1650	50	80	40	11.5	4	28	37	20	17	M16X1,5	32	22	143	106	20	M8	8	64	46,5	G 1/4	20,5	7	10	2	4
176-1640	50	100	40	11.5	4	28	37	20	17	M16X1,5	32	22	143	106	20	M8	8	64	46,5	G 1/4	20,5	7	10	2	4
176-1648	50	125	40	11.5	4	28	37	20	17	M16X1,5	32	22	143	106	20	M8	8	64	46,5	G 1/4	20,5	7	10	2	4
176-1657	50	160	40	11.5	4	28	37	20	17	M16X1,5	32	22	143	106	20	M8	8	64	46,5	G 1/4	20,5	7	10	2	4
176-1646	50	200	40	11.5	4	28	37	20	17	M16X1,5	32	22	143	106	20	M8	8	64	46,5	G 1/4	20,5	7	10	2	4
176-1645	50	250	40	11.5	4	28	37	20	17	M16X1,5	32	22	143	106	20	M8	8	64	46,5	G 1/4	20,5	7	10	2	4
176-1644	63	25	45	15	4	29	37	20	17	M16X1,5	32	22	158	121	20	M8	8	74	56,5	G 3/8	22	11	8,5	4	4
176-1643	63	50	45	15	4	29	37	20	17	M16X1,5	32	22	158	121	20	M8	8	74	56,5	G 3/8	22	11	8,5	4	4

Did you know?

RS PRO offers over 50,000 quality industrial products including:

- Pneumatic Adaptors, Fittings & Couplings
- Pneumatic Tubing & Air Hose
- Pneumatic Air Preparation
- Pneumatic Valves & Manifolds
- Pneumatic Instrumentation & Switches
- Hydraulic Fluids & Filtration
- Hydraulic Tubing & Hose
- Power Transmission - Belts, Pulleys, Gears, Sprockets, Couplings & Rotary Bearings

Explore our entire range online today.

DOUBLE ACTING CUSHIONED MAGNETIC

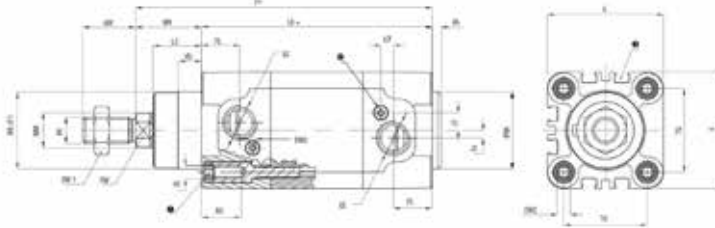

Stock No.	Ø	Stroke	ØB d11	VD	VA	L2	WH	Ø MM	SW	KK	AM	SW1	Z	L8	BG	RT	SW2	E	TG	EE	PL	J3	J2	L7	SW3
176-1642	63	80	45	15	4	29	37	20	17	M16X1,5	32	22	158	121	20	M8	8	74	56,5	G 3/8	22	11	8,5	4	4
176-1641	63	100	45	15	4	29	37	20	17	M16X1,5	32	22	158	121	20	M8	8	74	56,5	G 3/8	22	11	8,5	4	4
176-1666	63	125	45	15	4	29	37	20	17	M16X1,5	32	22	158	121	20	M8	8	74	56,5	G 3/8	22	11	8,5	4	4
176-1668	63	160	45	15	4	29	37	20	17	M16X1,5	32	22	158	121	20	M8	8	74	56,5	G 3/8	22	11	8,5	4	4
176-1649	63	200	45	15	4	29	37	20	17	M16X1,5	32	22	158	121	20	M8	8	74	56,5	G 3/8	22	11	8,5	4	4
176-1674	63	250	45	15	4	29	37	20	17	M16X1,5	32	22	158	121	20	M8	8	74	56,5	G 3/8	22	11	8,5	4	4
176-1673	80	25	45	15.7	4	35	46	25	22	M20X1,5	40	30	174	128	19	M10	6	94	72	G 3/8	22	11	8,5	4	4
176-1672	80	50	45	15.7	4	35	46	25	22	M20X1,5	40	30	174	128	19	M10	6	94	72	G 3/8	22	11	8,5	4	4
176-1671	80	80	45	15.7	4	35	46	25	22	M20X1,5	40	30	174	128	19	M10	6	94	72	G 3/8	22	11	8,5	4	4
176-1670	80	100	45	15.7	4	35	46	25	22	M20X1,5	40	30	174	128	19	M10	6	94	72	G 3/8	22	11	8,5	4	4
176-1669	80	125	45	15.7	4	35	46	25	22	M20X1,5	40	30	174	128	19	M10	6	94	72	G 3/8	22	11	8,5	4	4
176-1658	80	160	45	15.7	4	35	46	25	22	M20X1,5	40	30	174	128	19	M10	6	94	72	G 3/8	22	11	8,5	4	4
176-1667	80	200	45	15.7	4	35	46	25	22	M20X1,5	40	30	174	128	19	M10	6	94	72	G 3/8	22	11	8,5	4	4
176-1676	80	250	45	15.7	4	35	46	25	22	M20X1,5	40	30	174	128	19	M10	6	94	72	G 3/8	22	11	8,5	4	4
176-1665	100	25	55	19.2	4	38	51,5	25	22	M20X1,5	40	30	189,5	138	19	M10	6	111	89	G 1/2	26	9	12,5	5	4
176-1664	100	50	55	19.2	4	38	51,5	25	22	M20X1,5	40	30	189,5	138	19	M10	6	111	89	G 1/2	26	9	12,5	5	4
176-1663	100	80	55	19.2	4	38	51,5	25	22	M20X1,5	40	30	189,5	138	19	M10	6	111	89	G 1/2	26	9	12,5	5	4
176-1662	100	100	55	19.2	4	38	51,5	25	22	M20X1,5	40	30	189,5	138	19	M10	6	111	89	G 1/2	26	9	12,5	5	4
176-1661	100	125	55	19.2	4	38	51,5	25	22	M20X1,5	40	30	189,5	138	19	M10	6	111	89	G 1/2	26	9	12,5	5	4
176-1660	100	160	55	19.2	4	38	51,5	25	22	M20X1,5	40	30	189,5	138	19	M10	6	111	89	G 1/2	26	9	12,5	5	4
176-1659	100	200	55	19.2	4	38	51,5	25	22	M20X1,5	40	30	189,5	138	19	M10	6	111	89	G 1/2	26	9	12,5	5	4
176-1713	100	250	55	19.2	4	38	51,5	25	22	M20X1,5	40	30	189,5	138	19	M10	6	111	89	G 1/2	26	9	12,5	5	4

Mini Cylinders

The mini cylinders range presents a selection of double acting magnetic cylinders with bore diameters from 16 to 25mm.

Constructed of a stainless steel AISI 304 cylinder body with steel AISI 303 piston rod and sintered bronze bearing, the RS PRO range offers the ideal compact solution and is designed for use with filtered, lubricated and non-lubricated compressed air.

Features

- Main advantages**
- Zinc-plated steel Nut
 - Steel AISI 303 piston rod
 - Polyurethane rod seal
 - Anodised aluminium front cover
 - Zinc-plated steel nut
 - Sintered bronze bearing
 - NBR O-RING seals
 - Neoprene bumper
 - Brass piston
 - Polyurethane piston seal
 - Bonded ferrite magnet
 - Stainless steel AISI 304 mini cylinder shape body
 - Anodised aluminium back cover

DOUBLE ACTING MAGNETIC

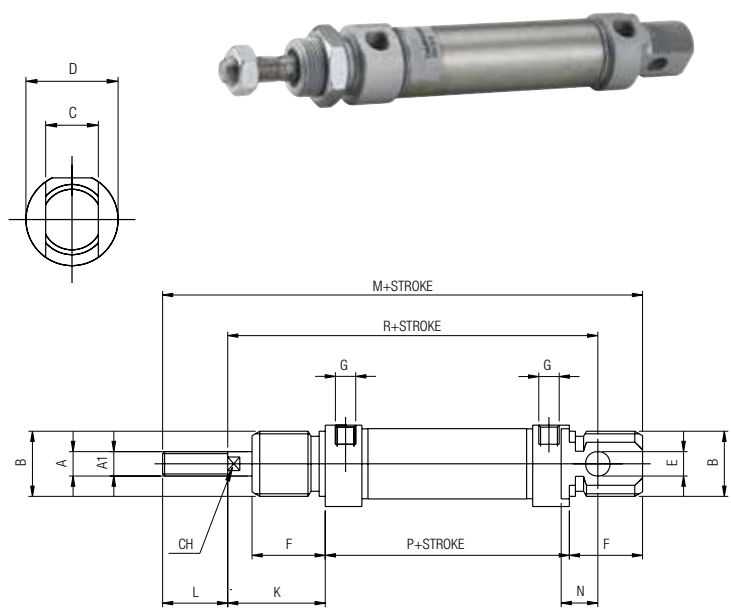

Stock No.	Ø	Stroke	A	A1	B	C	D	E	F	G	K	L	M	N	P	R	CH
176-1619	16	25	M6	6	M16X1,5	12	19	6	18	M5	22	16	109	9	53	82	5
176-1607	16	50	M6	6	M16X1,5	12	19	6	18	M5	22	16	109	9	53	82	5
176-1606	16	80	M6	6	M16X1,5	12	19	6	18	M5	22	16	109	9	53	82	5
176-1604	16	100	M6	6	M16X1,5	12	19	6	18	M5	22	16	109	9	53	82	5
176-1603	16	125	M6	6	M16X1,5	12	19	6	18	M5	22	16	109	9	53	82	5
176-1602	16	160	M6	6	M16X1,5	12	19	6	18	M5	22	16	109	9	53	82	5
176-1601	16	200	M6	6	M16X1,5	12	19	6	18	M5	22	16	109	9	53	82	5
176-1629	20	25	M8	8	M22X1,5	16	27	8	20	1/8G	24	20	131	12	67	95	7
176-1631	20	50	M8	8	M22X1,5	16	27	8	20	1/8G	24	20	131	12	67	95	7
176-1610	20	80	M8	8	M22X1,5	16	27	8	20	1/8G	24	20	131	12	67	95	7
176-1637	20	100	M8	8	M22X1,5	16	27	8	20	1/8G	24	20	131	12	67	95	7
176-1636	20	125	M8	8	M22X1,5	16	27	8	20	1/8G	24	20	131	12	67	95	7
176-1635	20	160	M8	8	M22X1,5	16	27	8	20	1/8G	24	20	131	12	67	95	7
176-1634	20	200	M8	8	M22X1,5	16	27	8	20	1/8G	24	20	131	12	67	95	7
176-1633	25	25	M10X1,25	10	M22X1,5	16	30	8	22	1/8G	28	22	140	12	68	104	9
176-1632	25	50	M10X1,25	10	M22X1,5	16	30	8	22	1/8G	28	22	140	12	68	104	9
176-1620	25	80	M10X1,25	10	M22X1,5	16	30	8	22	1/8G	28	22	140	12	68	104	9
176-1630	25	100	M10X1,25	10	M22X1,5	16	30	8	22	1/8G	28	22	140	12	68	104	9
176-1639	25	125	M10X1,25	10	M22X1,5	16	30	8	22	1/8G	28	22	140	12	68	104	9
176-1628	25	160	M10X1,25	10	M22X1,5	16	30	8	22	1/8G	28	22	140	12	68	104	9
176-1626	25	200	M10X1,25	10	M22X1,5	16	30	8	22	1/8G	28	22	140	12	68	104	9

Accessories for Cylinders

A selection of accessories for use with the RS PRO range of cylinders. We stock a range of accessories to speed system building and aid the correct working of a pneumatic installation.

YOKE WITH LOCABLE PIN

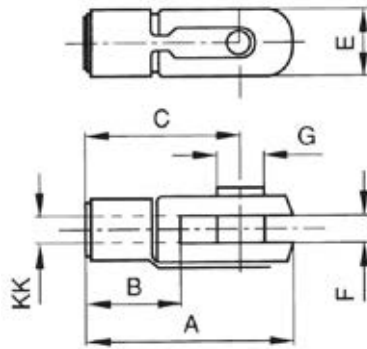

Stock No.	KK	A	B	C	E	F	G
176-1617	M6	31	12	24	12	6	6
176-1616	M8	42	16	32	16	8	8
176-1615	M10X1,25	52	20	40	20	10	10
176-1614	M12X1,25	62	24	48	24	12	12
176-1613	M16X1,5	83	32	64	32	16	16
176-1612	M20X1,5	105	40	80	40	20	20

CLEVIS BRACKET

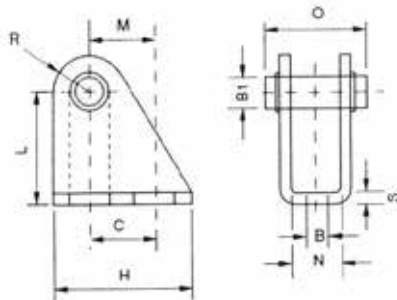

Stock No.	Ø	B	B1	C	H	L	M	N	O	R	S
176-1600	12-16	5,5	6	15	25	27	15	12,1	23	7	3
176-1609	20-25	6,6	8	20	32	30	20	16,1	29,5	10	4

FOOT

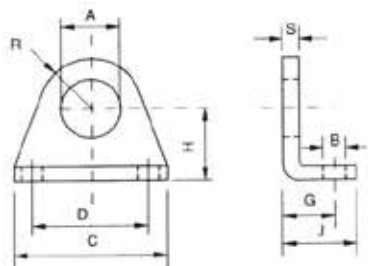

Stock No.	Ø	A	B	C	D	G	H	J	R	S
176-1622	12-16	16	5,5	42	32	14	20	20	13,5	4
176-1621	20-25	22	6,6	54	40	17	25	25	18	5

ROD ENDS SELF-LUBRICATING

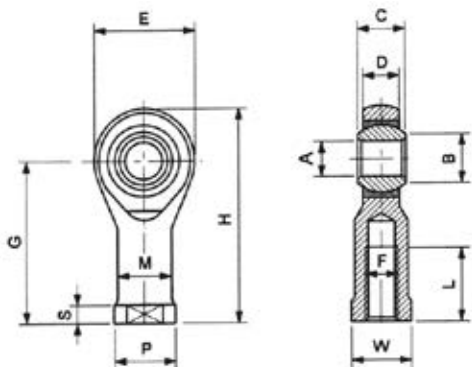

Stock No.	F	A	B	C	Sphere	D	E	G	H	L	M	P	S	W	Dynamic Radial Load Kg	Static Radial Load Kg	Weight (g)
176-1597	M6X1	6	8,9	9	12.7	6,75	20	30	40	9	10	13	5	11	470	1100	19
176-1568	M8X1,25	8	10,4	12	15.88	9	24	36	48	12	12,5	16	5	14	780	1900	36
176-1608	M10X1,25	10	12,9	14	19.05	10,5	28	43	57	15	15	19	6,5	17	1200	3100	88
176-1576	M12X1,25	12	15,4	16	22.23	12,5	34	50	67	18	17,5	22	6,5	18	1400	3700	120
176-1575	M16X1,5	16	19,3	21	28.58	15,5	42	64	85	24	22	27	8	24	2500	6300	240
176-1574	M20X1,5	20	24,4	25	34,93	18,5	50	77	102	30	27,5	34	10	30	3700	8300	430

FEMALE HINGE WITH SELF-LUBRICATING BUSHES - ALUMINIUM

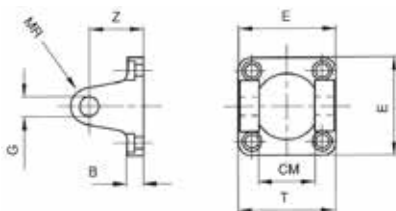

Stock No.	Ø	B	E	G	T	Z	CM	MR
176-1573	32	9	45	10	45	22	26	10
176-1572	40	9	52	12	52	25	28	12
176-1571	50	11	65	12	60	27	32	12
176-1561	63	11	75	16	70	32	40	16
176-1569	80	14	95	16	90	36	50	16
176-1578	100	14	115	20	110	41	60	20

MALE CLEVIS WITH SELF-LUBRICATING BUSHES - ALUMINIUM

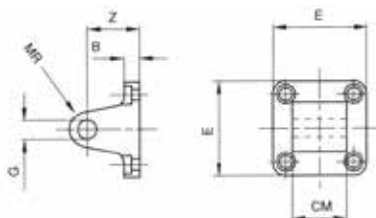

Stock No.	Ø	B	E	G	Z	CM	MR
176-1567	32	9	45	10	22	26	10
176-1566	40	9	52	12	25	28	12
176-1565	50	11	65	12	27	32	12
176-1564	63	11	75	16	32	40	16
176-1563	80	14	95	16	36	50	16
176-1562	100	14	115	20	41	60	20

LOW-RISE PEDESTAL - STEEL



Stock No.	Ø	B	C	E	F	O	U	V	R	Z	X	Y	H
176-1588	32	4	32	45	30	7	24	35	15	7	32,5	15,75	32
176-1590	40	4	36	52	30	9	28	36	17,5	7	38	17	36
176-1570	50	5	45	65	36	9	32	47	20	9	46,5	21,75	45
176-1596	63	5	50	75	35	9	32	45	22,5	9	56,5	21,75	50
176-1595	80	6	63	95	47	12	41	55	22,5	11	72	27	63
176-1594	100	6	75	115	53	14	41	57	27,5	11	89	26,5	71

PIN WITH SEEGER - STEEL

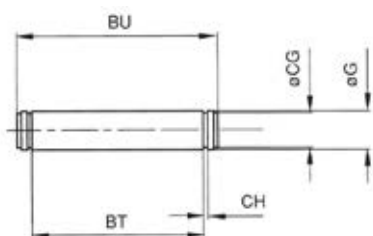

Stock No.	Ø	G	BT	BU	CG	CH
176-1593	32	10	46	53	9,6	1,1
176-1592	40	12	53	60	11,5	1,1
176-1591	50	12	61	68	11,5	1,1
176-1579	63	16	71	78	15,2	1,1
176-1589	80	16	91	98	15,2	1,1
176-1599	100	20	111	118	19	1,3

Air Treatment Units

Here we offer a range of components for filtration, regulation and lubrication of compressed air systems. Combined FR or FR+L units help with installation of the complete assembly to cleanse and rid the air of pollutants.

Features

Main advantages

- Modularity
- High flow rate
- Robust
- Light weight
- Silicon Free

Applications

- Pneumatic automation
- Compressed air circuits
- Compressors
- Compressed air pipeline

AIR DISTRIBUTOR

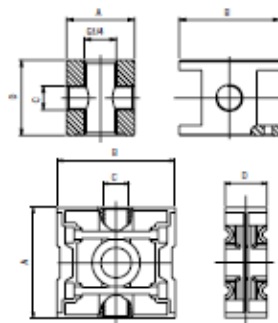

Stock No.	A	B	C	D
176-1730	42	45	1/4	24
176-1716	55	59	1/4	24
176-1717	65	70	3/8	32

MANOMETER BACK CONNECTION

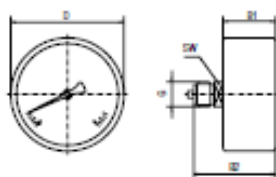

Stock No.	D	B1	B2	SW	G
176-1718	40	25	41.5	12	1/8

CONNECTION PLATE



Stock No.	Size
176-1733	FRL 1
176-1732	FRL 2
176-1747	FRL 3

FILTER

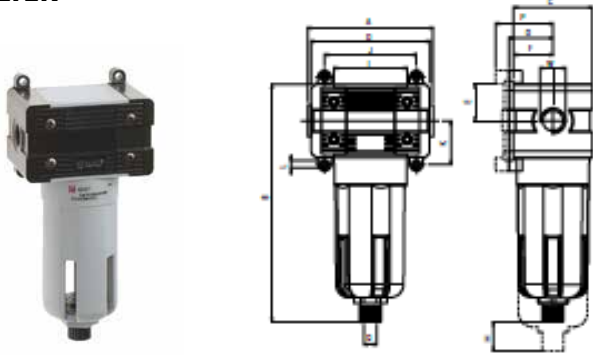

Stock No.	Size	Thread	Filtration	Flow Rate	Exhaust
176-1719	FIL 1	1/4	20 µm	1900 NI/min	S/M
176-1720	FIL 2	3/8	20 µm	3750 NI/min	S/M
176-1721	FIL 2	1/2	20 µm	3750 NI/min	S/M
176-1722	FIL 3	3/4	20 µm	6250 NI/min	S/M

REGULATOR

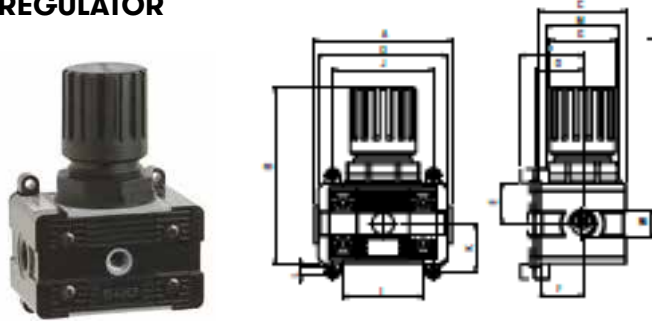

Stock No.	Size	Thread	Regulation	Flow Rate
176-1723	REG 1	1/4	0 ÷ 8 bar	2050 NI/min
176-1724	REG 2	3/8	0 ÷ 8 bar	3200 NI/min
176-1725	REG 2	1/2	0 ÷ 8 bar	3200 NI/min
176-1726	REG 3	3/4	0 ÷ 8 bar	6200 NI/min

FILTER REGULATOR

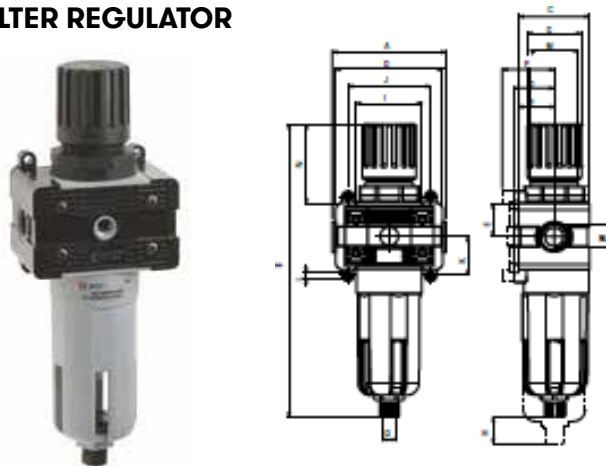

Stock No.	Size	Thread	Filtration	Regulation	Flow Rate	Exhaust
176-1727	FR 1	1/4	20 µm	0 ÷ 8 bar	1650 NI/min	S/M
176-1729	FR 2	3/8	20 µm	0 ÷ 8 bar	3000 NI/min	S/M
176-1738	FR 2	1/2	20 µm	0 ÷ 8 bar	3000 NI/min	S/M
176-1741	FR 3	3/4	20 µm	0 ÷ 8 bar	4500 NI/min	S/M

LUBRICATOR

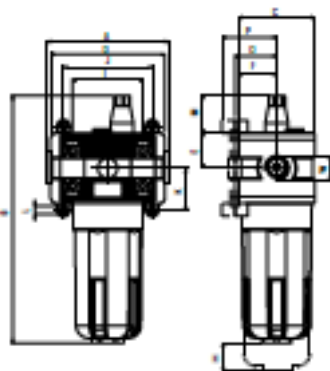

Stock No.	Size	Thread	Flow Rate	Oil loading System
176-1715	LUB 1	1/4	2600 NI/min	M
176-1746	LUB 2	3/8	5600 NI/min	M
176-1745	LUB 2	1/2	5600 NI/min	M
176-1744	LUB 3	3/4	8200 NI/min	M

SHUT OFF VALVE

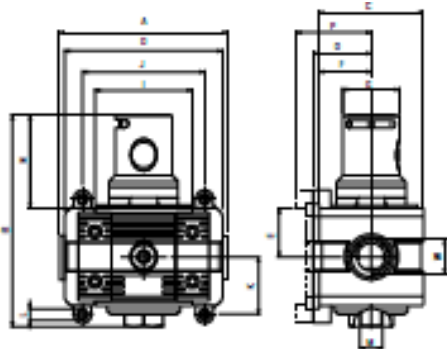

Stock No.	Size	Thread	Flow Rate	Drive
176-1743	V3V 1	1/4	1850 NI/min	M
176-1742	V3V 2	3/8	3000 NI/min	M
176-1731	V3V 2	1/2	3000 NI/min	M
176-1739	V3V 3	3/4	5200 NI/min	M

V + FR + L

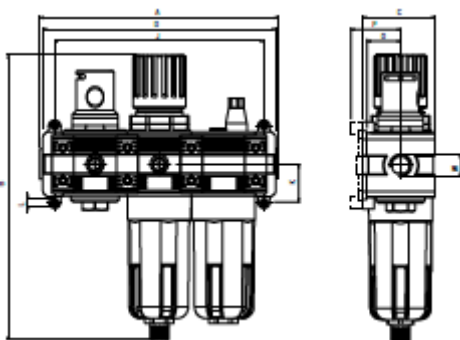

Stock No.	Size	Thread	Filtration	Regulation	Flow Rate
176-1748	V+FR+L 1	1/4	20 µm	0 ÷ 8 bar	800 NI/min
176-1737	V+FR+L 2	3/8	20 µm	0 ÷ 8 bar	2100 NI/min
176-1736	V+FR+L 2	1/2	20 µm	0 ÷ 8 bar	2100 NI/min
176-1735	V+FR+L 3	3/4	20 µm	0 ÷ 8 bar	3500 NI/min

Pressure and Vacuum Gauges

RS PRO presents a selection of general purpose pressure and vacuum gauges suitable for gaseous and liquid media. All are bottom entry with 3/8in or 1/2in connection.

Each gauge is encased in a highly durable stainless steel material making it perfect for applications where this is required. A range of maximum pressure measurements are offered and, with large analogue dial, are easy to read.

Features

Component Parts and Materials

- Instrument glass window
- Inbuilt restrictor screw
- Copper alloy element & movement
- Stainless steel case with G 3/8 in. BSPM (32mm flats)
- Bottom entry connection
- Ambient operating temperature between -20 and +60°C
- Operating temperature (Medium) +60°C
- 1.6 Per DIN 16005 accuracy class
- Calibrated versions available

PRESSURE AND VACUUM GAUGES



Stock No.	Gauge Outside Diameter (mm)	P (min) PSI	P (max) PSI	Connection Size (in)
188-992	100	-1	1	3/8
189-002	100	0	60	3/8
189-018	100	0	100	3/8
189-024	100	0	160	3/8
189-030	100	0	300	3/8
258-2330	100	0	1	1/2
258-2346	100	0	2.5	1/2
258-2352	100	0	4	1/2
258-2368	100	0	6	1/2
258-2380	100	0	10	1/2
258-2396	100	0	16	1/2
258-2403	100	0	25	1/2

Tubing

Supporting all pneumatic and some fluid applications, our range of RS PRO tubing is widely used across air brake, fuel and instrumentation applications and product line installations.

Standard tubing and **Light duty Nylon** tubing are ideal for low toxic, high temperature environments and applications involving food contact.

Superflex tubing is designed for use in compact pneumatic control systems. Offering superior flexibility, the need for elbow fittings is removed. It has a high impact resistance.

Polyurethane tubing can be used with push-fit adaptors and has exceptional abrasion and kink resistance, making it suitable for use with a wide range of chemicals.

STANDARD TUBING



Stock No.	Inside Diameter (mm)	Outside Diameter (mm)	Colour	Reel Length (m)
483-4914	2.5	4	Black	30
483-4936	2.5	4	Blue	30
483-4942	2.5	4	Yellow	30
483-4958	4	6	Black	30
483-4964	4	6	Green	30
483-4970	4	6	Blue	30
483-4986	4	6	Yellow	30
483-5018	5.5	8	Black	30
483-5030	5.5	8	Blue	30
483-5046	5.5	8	Yellow	30
483-5052	7	10	Black	30
483-5080	7	10	Blue	30
483-5103	8.5	12	Black	30
483-5541	2.5	4	Red	30
483-5585	5.5	8	Red	30
483-5608	7	10	Red	30

LIGHT DUTY NYLONTUBE



Stock No.	Inside Diameter (mm)	Outside Diameter (mm)	Colour	Reel Length (m)
415-0288	4.5	6	Natural	30
415-0345	6	8	Natural	30
415-0351	6	8	Black	30
415-0373	6	8	Green	30
415-0389	6	8	Red	30
415-0395	6	8	Blue	30
415-0402	6	8	Yellow	30
415-0480	9.5	12	Natural	30
415-0519	9.5	12	Red	30

SUPERFLEX TUBING



Stock No.	Inside Diameter (mm)	Outside Diameter (mm)	Colour	Reel Length (m)
415-0547	7	10	Natural	30
415-0553	7	10	Black	30
415-0569	7	10	Red	30
415-0597	8.5	12	Natural	30
415-0604	8.5	12	Black	30
415-0626	8.5	12	Blue	30
723-911	2.5	4	Natural	30
723-927	2.5	4	Black	30
723-933	2.5	4	Blue	30
723-949	2.5	4	Red	30
723-955	2.5	4	Green	30

POLYURETHANE TUBING



Stock No.	Inside Diameter (mm)	Outside Diameter (mm)	Colour	Reel Length (m)
917-2365	2.5	4	Black	30
917-2369	4	6	Black	30
917-2375	9	12	Black	30
917-2378	5	8	Black	30
917-2381	5	8	Blue	30
917-2384	2.5	4	Blue	30
917-2387	4	6	Blue	30
917-2390	7.5	10	Blue	30
917-2397	9	12	Blue	30
917-2400	4	6	Clear	30
917-2404	5	8	Clear	30
917-2410	4	6	Green	30
917-2413	9	12	Clear	30
917-2422	4	6	Red	30
917-2426	5	8	Red	30
917-2429	2.5	4	Red	30
917-2435	7.5	10	Red	30
917-2438	9	12	Red	30
917-2441	4	6	Yellow	30
917-2444	5	8	Yellow	30

EXPLORE OUR RANGE OF OVER 60,000 PRODUCTS

RS PRO is the own brand of RS and Allied that gives you every part you need across all industries at the quality and price you expect.

rspro.com



The RS PRO Seal of Approval - a sure sign of quality



AUDITED

In compliance with industry standards



INSPECTED

For guaranteed quality and performance



TESTED

By leading engineers



Since 1937, RS PRO has had a passion for industrial parts. More importantly, we believe that every part matters, because the quality of your applications will always be linked to the quality of every part going into them.

This is why we rigorously test every part against demanding industry standards to gain the RS PRO Seal of Approval.