

- > **Miniature size allows for easy installation and reduced footprints**
- > **Robust Poppet design provides exceptional product life**
- > **Closed Crossover design prevents unintended shifting**
- > **Choice of Toggle or Push button for easy actuation**
- > **Panel mountable & Swivel Input port allows for easy installation**
- > **High flow**



Technical features

Medium:

Compressed air, filtered, lubricated and non-lubricated

Operating Pressure:

26" Hg - 125 psi

Operating Temperature

-20°F to 160°F

Materials:

Aluminum Anodized, Brass Electroless Nickel, Acetal, Stainless Steel, Nylon, Buna-N

Operation:

Manual Toggle or Push Button

Mounting

Inline or panel

Panel Mounting:

Nominal mounting hole dimension

2/2NC & 3/2NC* = 31/64"

3/3 COE** = 25/32"

Port Size:

10-32, 1/8" NPT

Flow:

3/2NC*

2x3/2NO (3/3COE)

2x2/2NC

Cv = 0.42

Cv = 0.5 Ports 1-2

Cv = 0.54 Ports 1-2

*NC = Normally Closed

** COE = Center Open to Exhaust

Technical data

Model Number	Inlet Port Size Port 1	Outlet Ports Size		Function	Actuation	Actuation Force	
		Port 2	Port 3			At 50psi	At 125psi
NVC040201	1/8" NPT (F)	1/8" NPT (F)		2/2 Normally Closed	Detented Toggle/Toggle	13 oz	19 oz
NVC040203	1/8" NPT (F)	1/8" NPT (F)		2/2 Normally Closed	Toggle/Spring	13 oz	19 oz
NVC040205	1/8" NPT (F)	1/8" NPT (F)		2/2 Normally Closed	Push Button/Spring	3-1/2 lbs	5-2/1 lbs
NVC040221	1/8" NPT (F)	1/8" NPT (F)		2/2 Normally Closed	Detented Toggle/Toggle	13 oz	19 oz
NVC040223	1/8" NPT (F)	1/8" NPT (F)		2/2 Normally Closed	Toggle/Spring	13 oz	19 oz
NVC040225	1/8" NPT (F)	1/8" NPT (F)		2/2 Normally Closed	Push Button/Spring	3-1/2 lbs	5-2/1 lbs
NVC040101	1/8" NPT (F)	1/8" NPT (F)	1/8" NPT (F)	3/2 Normally Closed	Detented Toggle/Toggle	13 oz	19 oz
NVC040103	1/8" NPT (F)	1/8" NPT (F)	1/8" NPT (F)	3/2 Normally Closed	Toggle/Spring	13 oz	19 oz
NVC040105	1/8" NPT (F)	1/8" NPT (F)	1/8" NPT (F)	3/2 Normally Closed	Push Button/Spring	3-1/2 lbs	5-2/1 lbs
NVC040121	1/8" NPT (F)	1/8" NPT (F)	1/8" NPT (F)	3/2 Normally Closed	Detented Toggle/Toggle	13 oz	19 oz
NVC040123	1/8" NPT (F)	1/8" NPT (F)	1/8" NPT (F)	3/2 Normally Closed	Toggle/Spring	13 oz	19 oz
NVC040125	1/8" NPT (F)	1/8" NPT (F)	1/8" NPT (F)	3/2 Normally Closed	Push Button/Spring	3-1/2 lbs	5-2/1 lbs
NVC040401	1/8" NPT (F)	1/8" NPT (F)	1/8" NPT (F)	3/2 Normally Closed	Detented Toggle/Toggle	13 oz	19 oz
NVC040403	1/8" NPT (F)	1/8" NPT (F)	1/8" NPT (F)	3/2 Normally Closed	Toggle/Spring	13 oz	19 oz
NVC040405	1/8" NPT (F)	1/8" NPT (F)	1/8" NPT (F)	3/2 Normally Closed	Push Button/Spring	3-1/2 lbs	5-2/1 lbs
NVC040421	1/8" NPT (F)	1/8" NPT (F)	1/8" NPT (F)	3/2 Normally Closed	Detented Toggle/Toggle	13 oz	19 oz
NVC040423	1/8" NPT (F)	1/8" NPT (F)	1/8" NPT (F)	3/2 Normally Closed	Toggle/Spring	13 oz	19 oz
NVC040425	1/8" NPT (F)	1/8" NPT (F)	1/8" NPT (F)	3/2 Normally Closed	Push Button/Spring	3-1/2 lbs	5-2/1 lbs
NVC040501	1/8" NPT (F)	1/8" NPT (F)	1/8" NPT (F)	3/2 Normally Closed	Detented Toggle/Toggle	13 oz	19 oz
NVC040503	1/8" NPT (F)	1/8" NPT (F)	1/8" NPT (F)	3/2 Normally Closed	Toggle/Spring	13 oz	19 oz
NVC040505	1/8" NPT (F)	1/8" NPT (F)	1/8" NPT (F)	3/2 Normally Closed	Push Button/Spring	3-1/2 lbs	5-2/1 lbs
NVC040521	1/8" NPT (F)	1/8" NPT (F)	1/8" NPT (F)	3/2 Normally Closed	Detented Toggle/Toggle	13 oz	19 oz
NVC040523	1/8" NPT (F)	1/8" NPT (F)	1/8" NPT (F)	3/2 Normally Closed	Toggle/Spring	13 oz	19 oz
NVC040525	1/8" NPT (F)	1/8" NPT (F)	1/8" NPT (F)	3/2 Normally Closed	Push Button/Spring	3-1/2 lbs	5-2/1 lbs

Option selector

NVC*****

Seals	Substitute
Buna-N	0

Style and Function*	Substitute
Standard 3/2NC	401
Standard 2/2NC	402
Side Ported 3/2NC	404
Fully Ported 3/2NC	405

Actuator Style	Substitute
Detented Toggle	1
Momentary Toggle	3
Push Button	5

Actuator Material	Substitute
Nylon	0
Metal	2

*NC = Normally Closed

Technical data

Model Number	Inlet Port Size	Outlet Ports Size		Function	Actuation	Actuation Force	
	Port 1	Port 2	Port 3			At 50psi	At 125psi
NVC042601	1/8" NPT (F)	1/8" NPT (F)	Exhaust to Atmosphere	2x2/2NC	Detented Toggle/Toggle	72 oz	7-1/2 lbs
NVC042603	1/8" NPT (F)	1/8" NPT (F)	Exhaust to Atmosphere	2x2/2NC	Toggle/Spring	72 oz	7-1/2 lbs
NVC042601-HD	1/8" NPT (F)	1/8" NPT (F)	Exhaust to Atmosphere	2x2/2NC	Detented Toggle/Toggle	72 oz	7-1/2 lbs
NVC042603-HD	1/8" NPT (F)	1/8" NPT (F)	Exhaust to Atmosphere	2x2/2NC	Toggle/Spring	72 oz	7-1/2 lbs
NVC042501	1/8" NPT (F)	1/8" NPT (F)	Exhaust to Atmosphere	2x3/2NO (3/3COE)	Detented Toggle/Toggle	72 oz	7-1/2 lbs
NVC042503	1/8" NPT (F)	1/8" NPT (F)	Exhaust to Atmosphere	2x3/2NO (3/3COE)	Toggle/Spring	72 oz	7-1/2 lbs
NVC042501-HD	1/8" NPT (F)	1/8" NPT (F)	Exhaust to Atmosphere	2x3/2NO (3/3COE)	Detented Toggle/Toggle	72 oz	7-1/2 lbs
NVC042503-HD	1/8" NPT (F)	1/8" NPT (F)	Exhaust to Atmosphere	2x3/2NO (3/3COE)	Toggle/Spring	72 oz	7-1/2 lbs

Option selector

NVC*****

Seals	Substitute
Buna-N	0

Style and Function*	Substitute
2x3/2NO (3/3COE)	425
2x2/2NC	426

Actuator Style	Substitute
Standard	Blank
Heavy Duty Toggle	-HD

Actuator Material	Substitute
Detented Toggle	01
Momentary Toggle	03

**COE = Center Open to Exhaust

Dimensions

Standard

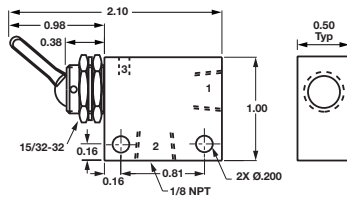

NVC040101 NVC040103
NVC040201 NVC040203

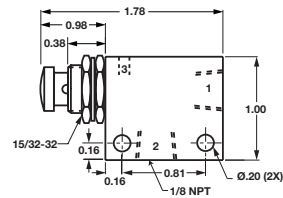

NVC040105 NVC040125
NVC040205 NVC040225

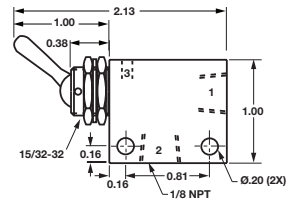

NVC040121 NVC040123
NVC040221 NVC040223

Fully Ported

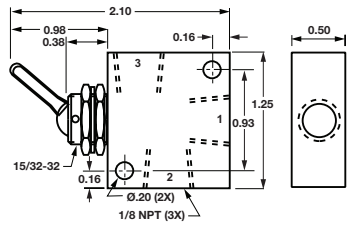

NVC040501 NVC040503

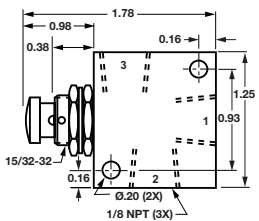

NVC040505 NVC040525

Side Ported

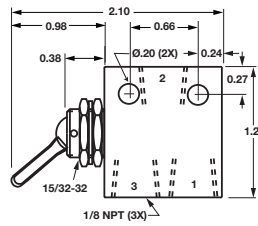

NVC040401 NVC040403

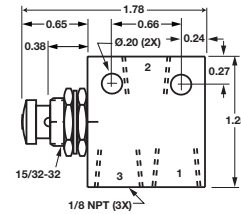

NVC040405 NVC040425

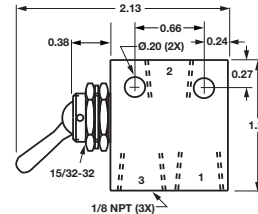

NVC040421 NVC040423

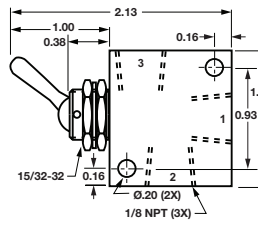

NVC040521 NVC040523

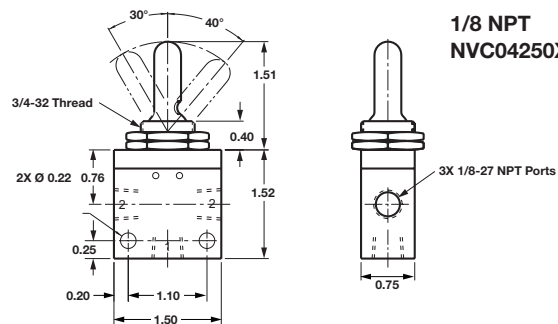

1/8 NPT
NVC04250X NVC04260X

Warning

Improper selection, misuse, age or malfunction of components used in systems can cause failure in various modes. The system designer is warned to consider the failure modes of all component parts and to provide adequate safeguards to prevent personal injury or damage to equipment or property in the event of such failure modes. System designers and end users are cautioned to consult instruction sheets and specifications available from the factory. The system designer/end user is responsible for verifying that all requirements for the application are met.

Warranty

The products described herein are warranted subject to seller's Standard Terms and Condition of Sale, available at seller's website.

Proposition 65: These products may contain chemicals known to the state of California to cause cancer, or birth defects, or other reproductive harm.