

- > **Miniature size allows for easy installation and reduced footprints**
- > **Robust Poppet design provides exceptional product life**
- > **Closed Crossover design prevents unintended shifting**
- > **Choice of Toggle or Push button for easy actuation**
- > **Panel mountable & Swivel Input port allows for easy installation**
- > **High flow**



Technical features

Medium:

Compressed air, filtered, lubricated and non-lubricated

Operating Pressure:

26" Hg - 125 psi

Operating Temperature

-20°F to 160°F

Materials:

Aluminum Anodized, Brass Electroless Nickel, Acetal, Stainless Steel, Nylon, Buna-N

Operation:

Manual Toggle or Push Button

Mounting

Inline or panel

Panel Mounting:

Nominal mounting hole dimension

2/2NC & 3/2NC* = 31/64"

3/3 COE** = 25/32"

Port Size:

10-32, 1/8" NPT

Flow:

3/2NC*

2x3/2NO (3/3COE)

2x2/2NC

Cv = 0.42

Cv = 0.5 Ports 1-2

Cv = 0.54 Ports 1-2

*NC = Normally Closed

** COE = Center Open to Exhaust

Technical data

| Model Number | Inlet Port Size Port 1 | Outlet Ports Size Port 2 | Outlet Ports Size Port 3 | Function | Actuation | Actuation Force | |
|--------------|---------------------------|-----------------------------|-----------------------------|---------------------|------------------------|-----------------|-----------|
| | | | | | | At 50psi | At 125psi |
| NVC040201 | 1/8" NPT (F) | 1/8" NPT (F) | | 2/2 Normally Closed | Detented Toggle/Toggle | 13 oz | 19 oz |
| NVC040203 | 1/8" NPT (F) | 1/8" NPT (F) | | 2/2 Normally Closed | Toggle/Spring | 13 oz | 19 oz |
| NVC040205 | 1/8" NPT (F) | 1/8" NPT (F) | | 2/2 Normally Closed | Push Button/Spring | 3-1/2 lbs | 5-2/1 lbs |
| NVC040221 | 1/8" NPT (F) | 1/8" NPT (F) | | 2/2 Normally Closed | Detented Toggle/Toggle | 13 oz | 19 oz |
| NVC040223 | 1/8" NPT (F) | 1/8" NPT (F) | | 2/2 Normally Closed | Toggle/Spring | 13 oz | 19 oz |
| NVC040225 | 1/8" NPT (F) | 1/8" NPT (F) | | 2/2 Normally Closed | Push Button/Spring | 3-1/2 lbs | 5-2/1 lbs |
| NVC040101 | 1/8" NPT (F) | 1/8" NPT (F) | 1/8" NPT (F) | 3/2 Normally Closed | Detented Toggle/Toggle | 13 oz | 19 oz |
| NVC040103 | 1/8" NPT (F) | 1/8" NPT (F) | 1/8" NPT (F) | 3/2 Normally Closed | Toggle/Spring | 13 oz | 19 oz |
| NVC040105 | 1/8" NPT (F) | 1/8" NPT (F) | 1/8" NPT (F) | 3/2 Normally Closed | Push Button/Spring | 3-1/2 lbs | 5-2/1 lbs |
| NVC040121 | 1/8" NPT (F) | 1/8" NPT (F) | 1/8" NPT (F) | 3/2 Normally Closed | Detented Toggle/Toggle | 13 oz | 19 oz |
| NVC040123 | 1/8" NPT (F) | 1/8" NPT (F) | 1/8" NPT (F) | 3/2 Normally Closed | Toggle/Spring | 13 oz | 19 oz |
| NVC040125 | 1/8" NPT (F) | 1/8" NPT (F) | 1/8" NPT (F) | 3/2 Normally Closed | Push Button/Spring | 3-1/2 lbs | 5-2/1 lbs |
| NVC040401 | 1/8" NPT (F) | 1/8" NPT (F) | 1/8" NPT (F) | 3/2 Normally Closed | Detented Toggle/Toggle | 13 oz | 19 oz |
| NVC040403 | 1/8" NPT (F) | 1/8" NPT (F) | 1/8" NPT (F) | 3/2 Normally Closed | Toggle/Spring | 13 oz | 19 oz |
| NVC040405 | 1/8" NPT (F) | 1/8" NPT (F) | 1/8" NPT (F) | 3/2 Normally Closed | Push Button/Spring | 3-1/2 lbs | 5-2/1 lbs |
| NVC040421 | 1/8" NPT (F) | 1/8" NPT (F) | 1/8" NPT (F) | 3/2 Normally Closed | Detented Toggle/Toggle | 13 oz | 19 oz |
| NVC040423 | 1/8" NPT (F) | 1/8" NPT (F) | 1/8" NPT (F) | 3/2 Normally Closed | Toggle/Spring | 13 oz | 19 oz |
| NVC040425 | 1/8" NPT (F) | 1/8" NPT (F) | 1/8" NPT (F) | 3/2 Normally Closed | Push Button/Spring | 3-1/2 lbs | 5-2/1 lbs |
| NVC040501 | 1/8" NPT (F) | 1/8" NPT (F) | 1/8" NPT (F) | 3/2 Normally Closed | Detented Toggle/Toggle | 13 oz | 19 oz |
| NVC040503 | 1/8" NPT (F) | 1/8" NPT (F) | 1/8" NPT (F) | 3/2 Normally Closed | Toggle/Spring | 13 oz | 19 oz |
| NVC040505 | 1/8" NPT (F) | 1/8" NPT (F) | 1/8" NPT (F) | 3/2 Normally Closed | Push Button/Spring | 3-1/2 lbs | 5-2/1 lbs |
| NVC040521 | 1/8" NPT (F) | 1/8" NPT (F) | 1/8" NPT (F) | 3/2 Normally Closed | Detented Toggle/Toggle | 13 oz | 19 oz |
| NVC040523 | 1/8" NPT (F) | 1/8" NPT (F) | 1/8" NPT (F) | 3/2 Normally Closed | Toggle/Spring | 13 oz | 19 oz |
| NVC040525 | 1/8" NPT (F) | 1/8" NPT (F) | 1/8" NPT (F) | 3/2 Normally Closed | Push Button/Spring | 3-1/2 lbs | 5-2/1 lbs |

Option selector

NVC*****

| Seals | Substitute |
|--------|------------|
| Buna-N | 0 |

| Style and Function* | Substitute |
|---------------------|------------|
| Standard 3/2NC | 401 |
| Standard 2/2NC | 402 |
| Side Ported 3/2NC | 404 |
| Fully Ported 3/2NC | 405 |

| Actuator Style | Substitute |
|------------------|------------|
| Detented Toggle | 1 |
| Momentary Toggle | 3 |
| Push Button | 5 |

| Actuator Material | Substitute |
|-------------------|------------|
| Nylon | 0 |
| Metal | 2 |

*NC = Normally Closed

Technical data

| Model Number | Inlet Port Size | Outlet Ports Size | | Function | Actuation | Actuation Force | |
|--------------|-----------------|-------------------|-----------------------|------------------|------------------------|-----------------|-----------|
| | Port 1 | Port 2 | Port 3 | | | At 50psi | At 125psi |
| NVC042601 | 1/8" NPT (F) | 1/8" NPT (F) | Exhaust to Atmosphere | 2x2/2NC | Detented Toggle/Toggle | 72 oz | 7-1/2 lbs |
| NVC042603 | 1/8" NPT (F) | 1/8" NPT (F) | Exhaust to Atmosphere | 2x2/2NC | Toggle/Spring | 72 oz | 7-1/2 lbs |
| NVC042601-HD | 1/8" NPT (F) | 1/8" NPT (F) | Exhaust to Atmosphere | 2x2/2NC | Detented Toggle/Toggle | 72 oz | 7-1/2 lbs |
| NVC042603-HD | 1/8" NPT (F) | 1/8" NPT (F) | Exhaust to Atmosphere | 2x2/2NC | Toggle/Spring | 72 oz | 7-1/2 lbs |
| NVC042501 | 1/8" NPT (F) | 1/8" NPT (F) | Exhaust to Atmosphere | 2x3/2NO (3/3COE) | Detented Toggle/Toggle | 72 oz | 7-1/2 lbs |
| NVC042503 | 1/8" NPT (F) | 1/8" NPT (F) | Exhaust to Atmosphere | 2x3/2NO (3/3COE) | Toggle/Spring | 72 oz | 7-1/2 lbs |
| NVC042501-HD | 1/8" NPT (F) | 1/8" NPT (F) | Exhaust to Atmosphere | 2x3/2NO (3/3COE) | Detented Toggle/Toggle | 72 oz | 7-1/2 lbs |
| NVC042503-HD | 1/8" NPT (F) | 1/8" NPT (F) | Exhaust to Atmosphere | 2x3/2NO (3/3COE) | Toggle/Spring | 72 oz | 7-1/2 lbs |

Option selector

NVC*****

| Seals | Substitute |
|--------|------------|
| Buna-N | 0 |

| Style and Function* | Substitute |
|---------------------|------------|
| 2x3/2NO (3/3COE) | 425 |
| 2x2/2NC | 426 |

| Actuator Style | Substitute |
|-------------------|--------------|
| Standard | Blank |
| Heavy Duty Toggle | -HD |

| Actuator Material | Substitute |
|-------------------|------------|
| Detented Toggle | 01 |
| Momentary Toggle | 03 |

**COE = Center Open to Exhaust

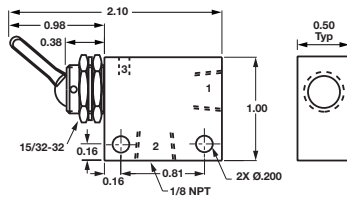
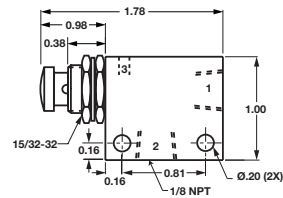
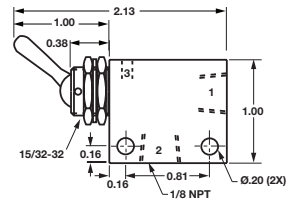
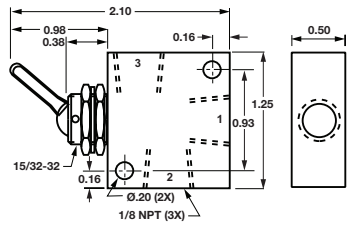
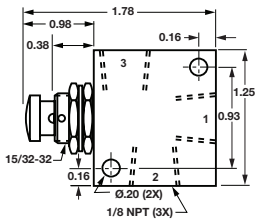
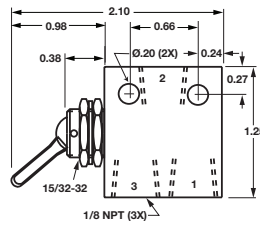
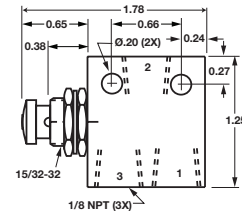
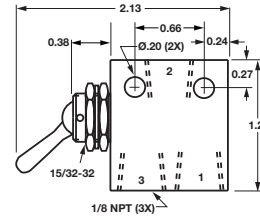
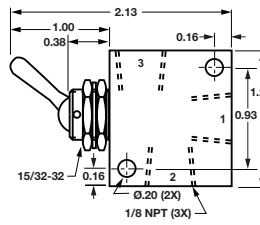
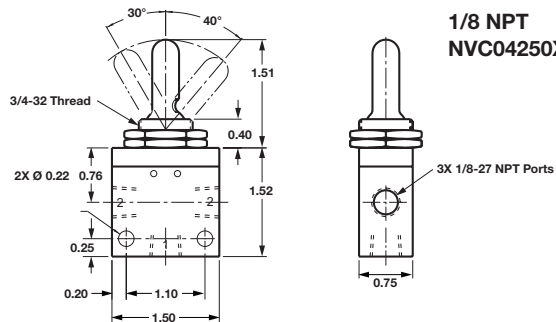
Dimensions
Standard

NVC040101 NVC040103
NVC040201 NVC040203

NVC040105 NVC040125
NVC040205 NVC040225

NVC040121 NVC040123
NVC040221 NVC040223
Fully Ported

NVC040501 NVC040503

NVC040505 NVC040525
Side Ported

NVC040401 NVC040403

NVC040405 NVC040425

NVC040421 NVC040423

NVC040521 NVC040523

1/8 NPT
NVC04250X NVC04260X
Warning

Improper selection, misuse, age or malfunction of components used in systems can cause failure in various modes. The system designer is warned to consider the failure modes of all component parts and to provide adequate safeguards to prevent personal injury or damage to equipment or property in the event of such failure modes. System designers and end users are cautioned to consult instruction sheets and specifications available from the factory. The system designer/end user is responsible for verifying that all requirements for the application are met.

Warranty

The products described herein are warranted subject to seller's Standard Terms and Condition of Sale, available at seller's website.

Proposition 65: These products may contain chemicals known to the state of California to cause cancer, or birth defects, or other reproductive harm.