

PLEASE CHECK WWW.MOLEX.COM FOR LATEST PART INFORMATION

Part Number: [1300150062](#)
Status: **Active**
Overview: [Brad Mini-Change Connectors](#)
Description: Mini-Change C-Size Receptacle with Leads 1/2" - 14 NPT Threads, Female (Straight), 12 Poles, 1.83m (6.0') Length

Documents:

[Drawing \(PDF\)](#) [RoHS Certificate of Compliance \(PDF\)](#)

Agency Certification

CSA LR6837
 UL E152210

General

Product Family Industrial Receptacles
 Series [130015](#)
 Comments C-Size (1-1/8" - 16 UN-2A), C-Size (1-1/8" - 16 UN-2A)
 IP Rating IP67
 Overview [Brad Mini-Change Connectors](#)
 Product Name Mini-Change
 Type Single Ended (pigtail)
 UPC 78678806831

Physical

Coupling Type External Thread
 Gender Female
 Keyway Single
 Length 1.83m
 Material - Component Zinc Die-Cast with Black Epoxy
 Mounting Thread Size 1/2" - 14 NPT
 Orientation Straight
 Panel Mount N/A
 Poles 12
 Temperature Range - Operating -20°C to +105°C
 Wire Size AWG 16
 Wire/Cable Type UL 1015

Electrical

Current - Maximum per Contact 5.0A
 Voltage - Maximum 600V AC/DC

Material Info

Engineering Number 3R2004A20F060

Reference - Drawing Numbers

Sales Drawing SD-130015-007, SD-130015-026

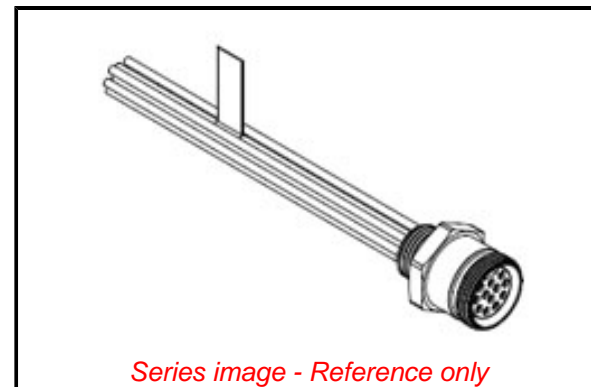

Series image - Reference only

EU ELV

Not Relevant

EU RoHS

Not Reviewed

REACH SVHC

Not Reviewed

Halogen-Free

Status

Not Reviewed

For more information, please visit [Contact US](#)

China ROHS Not Reviewed

ELV Not Relevant

RoHS Phthalates Not Reviewed

China RoHS

Search Parts in this Series

[130015 Series](#)