

# XMLB070D2S13

pressure switch XMLB 70 bar - adjustable  
scale 2 thresholds - 1 C/O



Product availability: Non-Stock - Not normally stocked in distribution facility



## Main

Range of product	OsiSense XM
Product or component type	Electromechanical pressure sensor
Pressure sensor type	Electromechanical pressure sensor
Device short name	XMLB
Pressure sensor size	1015.26 psi (70 bar)
Controlled fluid	Hydraulic oil 32...320 °F (0...160 °C))
Fluid connection type	1/4" - 18 NPTF (female)
Electrical connection	Screw-clamps terminals, 1 x 0.5...2 x 2.5 mm <sup>2</sup>
AWG gauge	AWG 20...AWG 14
Cable entry	Cable gland 0.28...0.51 in (7...13 mm)
Contacts type and composition	1 C/O
Product specific application	-
Pressure switch type of operation	Regulation between 2 thresholds
Electrical circuit type	Control circuit
Scale type	Adjustable differential
Local display	With
Adjustable range of switching point on rising pressure	101.53...1015.26 psi (7...70 bar)
Adjustable range of switching point on falling pressure	33.36...887.63 psi (2.3...61.2 bar)
Possible differential maximum at high setting	725.19 psi (50 bar)
Maximum permissible accidental pressure	2320.60 psi (160 bar)
Destruction pressure	4641.21 psi (320 bar)
Pressure actuator	Piston
Materials in contact with fluid	PTFE Brass FPM, FKM Steel
Enclosure material	Zinc alloy
Line Rated Current	3 A, B300, AC-15 (Ue = 120 V)EN/IEC 60947-5-1 1.5 A, B300, AC-15 (Ue = 240 V)EN/IEC 60947-5-1 0.1 A, R300, DC-13 (Ue = 250 V)EN/IEC 60947-5-1

## Complementary

Possible differential minimum at low setting	68.17 psi (4.7 bar) - 0.4 bar, + 0.7 bar)
Possible differential minimum at high setting	127.63 psi (8.8 bar) - 0.6 bar, + 0.8 bar)
Maximum permissible pressure - per cycle	1305.34 psi (90 bar)
Terminal block type	4 terminals
Maximum operating rate	60 cyc/mn
Repeat accuracy	2 %
[Ui] rated insulation voltage	300 V UL 508 500 V EN/IEC 60947-1 300 V CSA C22.2 No 14

The information provided in this documentation contains general descriptions and/or technical characteristics of the performance of the products contained herein. This documentation is not intended as a substitute for and is not to be used for determining suitability or reliability of these products for specific user applications. It is the duty of any such user or integrator to perform the appropriate and complete risk analysis, evaluation and testing of the products with respect to the relevant specific application or use thereof. Neither Schneider Electric Industries SAS nor any of its affiliates or subsidiaries shall be responsible or liable for misuse of the information contained herein.

[Uimp] rated impulse withstand voltage	6 kV EN/IEC 60947-1
Auxiliary contacts operation	Snap action
Contacts material	Silver contacts
Maximum resistance across terminals	25 MOhm IEC 255-7 category 3 25 mOhm NF C 93-050 method A
Short-circuit protection	10 A cartridge fuse gG (gl)
Mechanical durability	6000000 cycles
Setting	External
Height	4.45 in (113 mm)
Depth	2.95 in (75 mm)
Width	1.38 in (35 mm)
Net weight	1.58 lb(US) (0.715 kg)



## Environment

Standards	EN/IEC 60947-5-1 CE CSA C22.2 No 14 UL 508
Product certifications	EAC CSA CCC LROS (Lloyds register of shipping) UL BV
Protective treatment	TC standard version
Ambient air temperature for operation	-13...158 °F (-25...70 °C)
Ambient air temperature for storage	-40...158 °F (-40...70 °C)
Operating position	Any position
Vibration resistance	4 gn 30...500 Hz)IEC 60068-2-6
Shock resistance	50 gn IEC 60068-2-27
Electrical shock protection class	Class I IEC 1140 Class I IEC 536 Class I NF C 20-030
IP degree of protection	IP66 EN/IEC 60529

## Ordering and shipping details

Category	22661 - XMLA,B,C,D PRESSURE SWITCHES
Discount Schedule	DS2
GTIN	00785901494874
Package weight(Lbs)	0.77 kg (1.69 lb(US))
Returnability	No
Country of origin	CZ

## Offer Sustainability

Sustainable offer status	Green Premium product
REACH Regulation	 <a href="#">REACH Declaration</a>
EU RoHS Directive	Pro-active compliance (Product out of EU RoHS legal scope)  <a href="#">EU RoHS Declaration</a>
Mercury free	Yes
RoHS exemption information	 <a href="#">Yes</a>
Environmental Disclosure	 <a href="#">Product Environmental Profile</a>
Circularity Profile	No need of specific recycling operations

## Contractual warranty

Warranty	18 months
----------	-----------

Dimensions

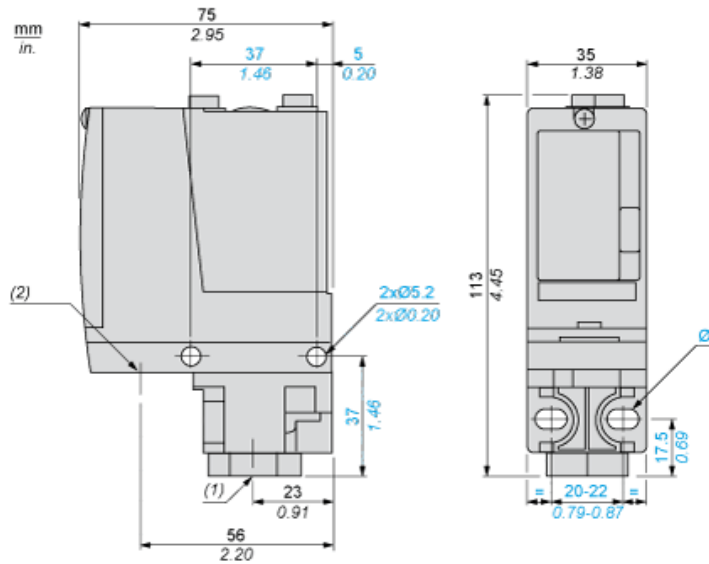

- (1) 1 fluid entry, tapped 1/4" NPTF  
(2) 1 electrical connections entry, tapped 1/2" NPT  
Ø : 2 elongated holes Ø 5.2 x 6.7

---

## Wiring Diagram

---

### Terminal Model

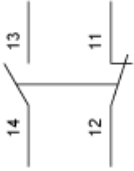

Operating Curves

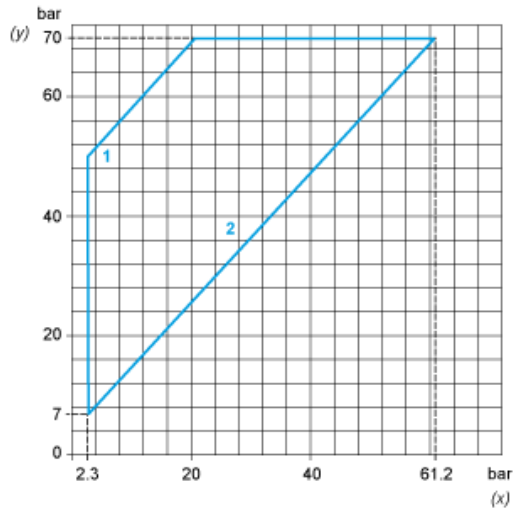

- (y) Rising pressure
- (x) Falling pressure
- 1 : Maximum differential
- 2 : Minimum differential

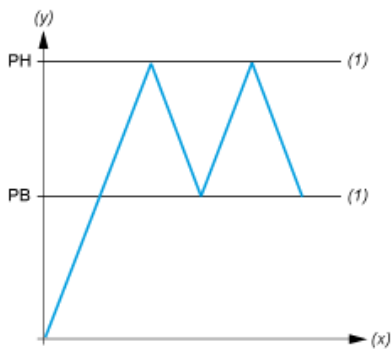

- (y) Pressure
- (x) Time
- (1) Adjustable value
- PH : High point
- PB : Below point