

# XMLB002A2S11

pressure switch XMLB 2.5 bar - adjustable  
scale 2 thresholds - 1 C/O



Product availability: Non-Stock - Not normally stocked in distribution facility



## Main

Range of product	OsiSense XM
Product or component type	Electromechanical pressure sensor
Pressure sensor type	Electromechanical pressure sensor
Device short name	XMLB
Pressure sensor size	36.26 psi (2.5 bar)
Controlled fluid	Air 32...158 °F (0...70 °C) Fresh water 32...158 °F (0...70 °C) Hydraulic oil 32...158 °F (0...70 °C)
Fluid connection type	G 1/4 (female) ISO 228
Electrical connection	Screw-clamps terminals, 1 x 0.5...2 x 2.5 mm <sup>2</sup> 1 connector Pg 13
AWG gauge	AWG 20...AWG 14
Cable entry	Cable gland 0.35...0.51 in (9...13 mm)
Contacts type and composition	1 C/O
Product specific application	-
Pressure switch type of operation	Regulation between 2 thresholds
Electrical circuit type	Control circuit
Scale type	Adjustable differential
Local display	With
Adjustable range of switching point on rising pressure	4.35...36.26 psi (0.3...2.5 bar)
Adjustable range of switching point on falling pressure	2.03...33.21 psi (0.14...2.29 bar)
Possible differential maximum at high setting	25.38 psi (1.75 bar)
Maximum permissible accidental pressure	130.53 psi (9 bar)
Destruction pressure	261.07 psi (18 bar)
Pressure actuator	Diaphragm
Materials in contact with fluid	Nitrile Zinc alloy
Enclosure material	Zinc alloy
Line Rated Current	3 A, B300, AC-15 (Ue = 120 V)EN/IEC 60947-5-1 1.5 A, B300, AC-15 (Ue = 240 V)EN/IEC 60947-5-1 0.1 A, R300, DC-13 (Ue = 250 V)EN/IEC 60947-5-1

## Complementary

Possible differential minimum at low setting	2.32 psi (0.16 bar) - 0.03 bar, + 0.05 bar
Possible differential minimum at high setting	3.05 psi (0.21 bar) - 0.03 bar, + 0.05 bar
Maximum permissible pressure - per cycle	72.52 psi (5 bar)
Terminal block type	4 terminals
Maximum operating rate	120 cyc/mn
Repeat accuracy	2 %

[Ui] rated insulation voltage	300 V UL 508 500 V EN/IEC 60947-1 300 V CSA C22.2 No 14
[Uimp] rated impulse withstand voltage	6 kV EN/IEC 60947-1
Auxiliary contacts operation	Snap action
Contacts material	Silver contacts
Maximum resistance across terminals	25 MOhm IEC 255-7 category 3 25 mOhm NF C 93-050 method A
Short-circuit protection	10 A cartridge fuse gG (gl)
Mechanical durability	8000000 cycles
Setting	External
Height	4.45 in (113 mm)
Depth	2.95 in (75 mm)
Width	2.17 in (55 mm)
Net weight	2.24 lb(US) (1.015 kg)





## Environment

Standards	CE CSA C22.2 No 14 EN/IEC 60947-5-1 UL 508
Product certifications	EAC BV UL LROS (Lloyds register of shipping) CCC CSA
Protective treatment	TC standard version
Ambient air temperature for operation	-13...158 °F (-25...70 °C)
Ambient air temperature for storage	-40...158 °F (-40...70 °C)
Operating position	Any position
Vibration resistance	4 gn 30...500 Hz)IEC 60068-2-6
Shock resistance	50 gn IEC 60068-2-27
Electrical shock protection class	Class I IEC 1140 Class I IEC 536 Class I NF C 20-030
IP degree of protection	IP66 EN/IEC 60529

## Ordering and shipping details

Category	22661 - XMLA,B,C,D PRESSURE SWITCHES
Discount Schedule	DS2
GTIN	00785901597858
Package weight(Lbs)	1.01 kg (2.23 lb(US))
Returnability	No
Country of origin	CZ

## Offer Sustainability

Sustainable offer status	Green Premium product
REACH Regulation	 <a href="#">REACH Declaration</a>
EU RoHS Directive	Pro-active compliance (Product out of EU RoHS legal scope)  <a href="#">EU RoHS Declaration</a>
Mercury free	Yes
RoHS exemption information	 <a href="#">Yes</a>
Environmental Disclosure	 <a href="#">Product Environmental Profile</a>
Circularity Profile	No need of specific recycling operations

## Contractual warranty

Warranty	18 months
----------	-----------

Dimensions

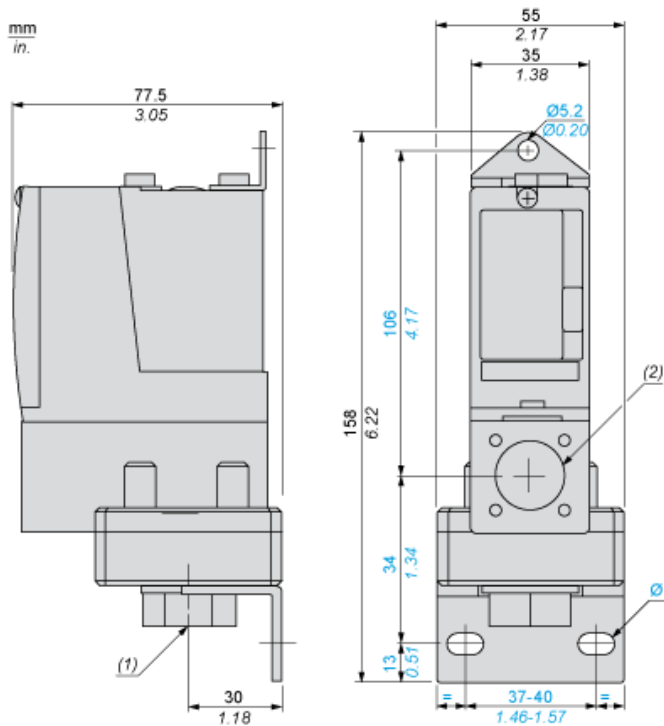

- (1) 1 fluid entry, tapped G1/4 (BSP female)
- (2) 1 electrical connections entry, tapped Pg 13.5
- $\varnothing$  : 2 elongated holes  $\varnothing 10.2 \times 5.2$

---

Wiring Diagram

---

Terminal Model



Operating Curves

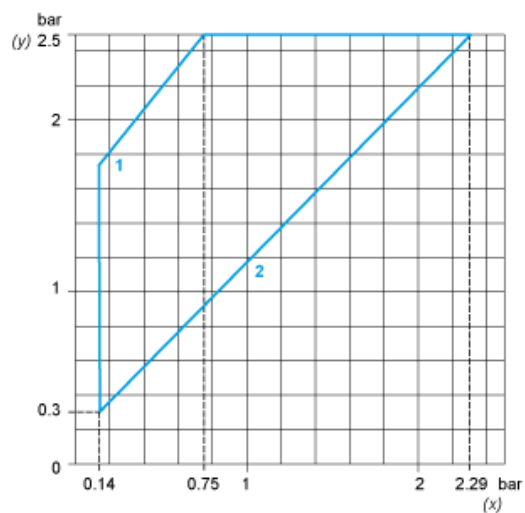

- (y) Rising pressure
- (x) Falling pressure
- 1 : Maximum differential
- 2 : Minimum differential

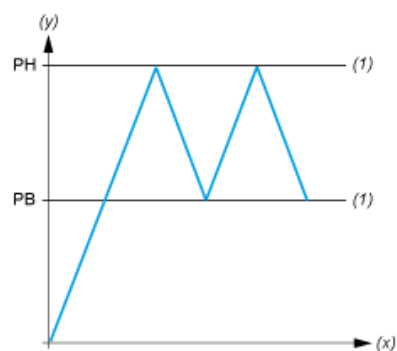

- (y) Pressure
- (x) Time
- (1) Adjustable value
- PH : High point
- PB : Below point