

Safety Laser Scanner OS32C

Compliant with PLd/Safety Category 3

Compact, Lightweight and Easy-To-Use Safety Laser Scanner



EtherNet/IP™

» Compact, power-saving scanner for AGV

» EtherNet/IP to improve interoperability with standard control

» Easy zone configuration using PC

Low profile allows installation in small spaces

For collision avoidance of AGVs (Automated Guided Vehicles)

For intrusion detection through an entrance

For presence detection within a machine's hazardous area

Operating state can be determined at a glance

Eight sector indicators* show the direction of intrusion. Front display shows operating state and error codes.

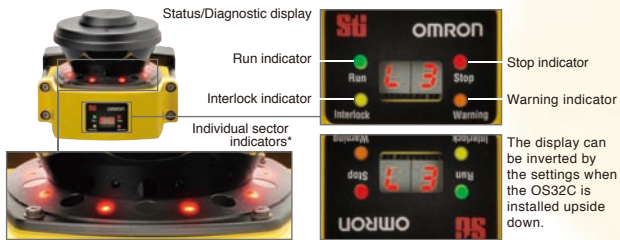

* US patent No. for individual sector indicators: US 6,753,776 B2

Integrated management via Ethernet

Industry's first Ethernet-compliant Safety Laser Scanner allows the user to check operating state and analyze the cause of an emergency stop via LAN even in large-scale applications using multiple scanners.

* Multiple OS32Cs cannot be monitored simultaneously.

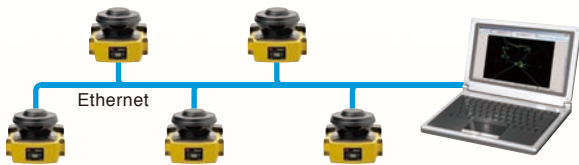

Setting 70 combinations

For complex AGV applications, up to 70 combinations - each with one safety zone and two warning zones - can be set. The two warning zones can be set to support various purposes such as warning sound and speed control.

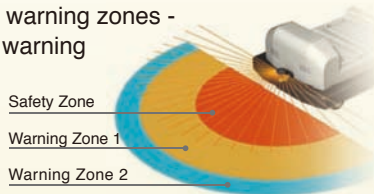

Simplified Wiring

OMRON STI's innovative I/O method requires fewer inputs when configuring multiple zones. Only 4 inputs are required to select from 6 zone sets. If all 8 inputs are used, up to 70 zone sets are available.

104.5mm

133.0mm

142.7mm

Features

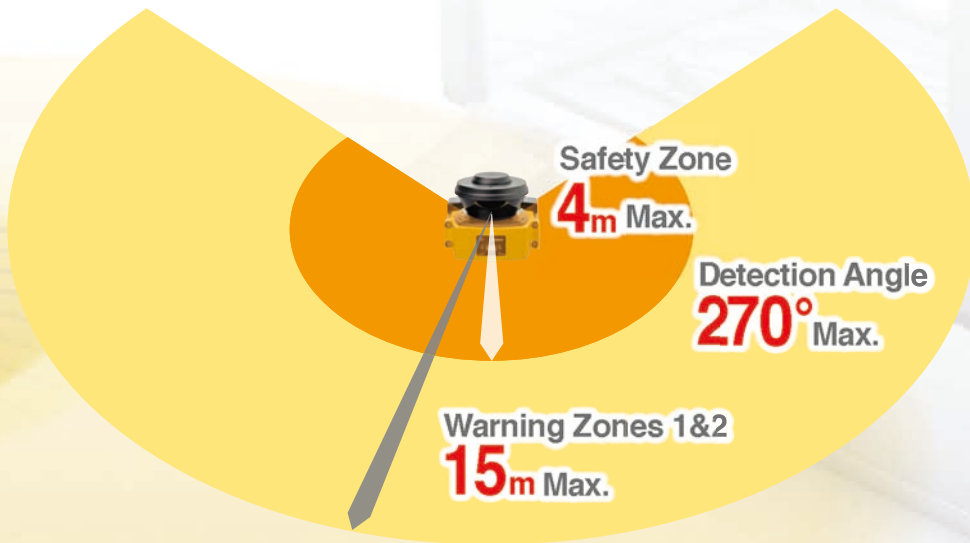

Compact size allows:
4m* safety zone,
270° detection angle.

* When Safety Zone is maximum 4m, the minimum object resolution is 70mm.

World's Most Compact Level*

Small size

104.5 mm *As of March,2014

Compact and versatile safety laser scanner

Lightweight

1.3 kg

Lightweight body for easy handling and installation

Low Power Consumption

5 w

Power saving, low power consumption(3.75 W in standby mode)

Reducing Erroneous Detections in Safety Zone **NEW**

PTM (Pollution Tolerance Mode) enables a filter that allows the OS32C to distinguish between more than one detected reflection pulses. Ignoring small reflection pulses which could be caused by airborne dust or other contaminants in the safety zone. This function prevents nuisance machine stops due to dust.

The OS32C determines the safety zone is clear by detecting a reference object reflection pulse and does not stop the machine.

The size of a reflection pulse is distinguished through the filter, and a small pollution reflection pulse is ignored.

Reference object such as guard

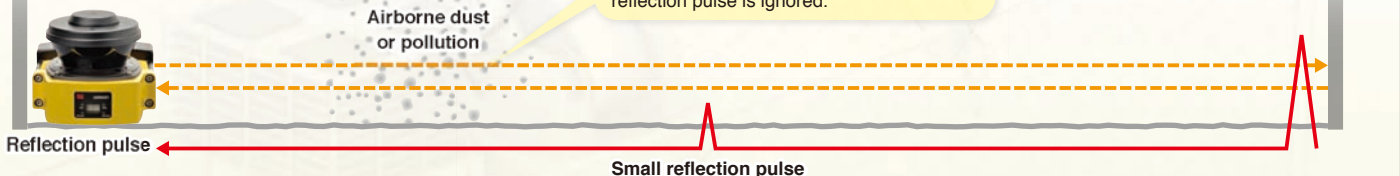

No reflection pulse returns from the reference object due to an interruption by a human body. The OS32C stops the machine by detecting an intrusion (human body) in the safety zone.

Human body

No reflection pulse returns from the reference object.

Reference object such as guard

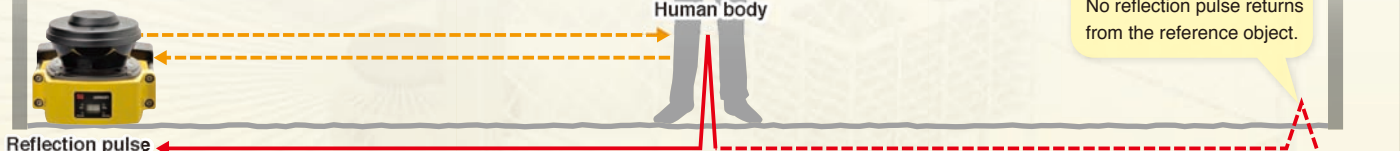

New convenient and easy-to-use functions

Replacable sensor, no reprogramming needed

No reprogramming needed, the configuration is stored in the I/O block. Replacing a damaged sensor is fast and easy.

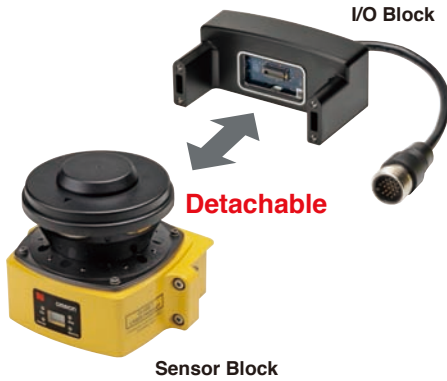

Reference Boundary Monitoring function

The OS32C constantly monitors reference points and turns OFF the safety outputs when a shift in its position is detected.

(Per international standard IEC 61496-3, area scanners used in applications where the angle of approach exceeds +/- 30 degrees with respect to the detection plane, must use RBM in the detection zone.)

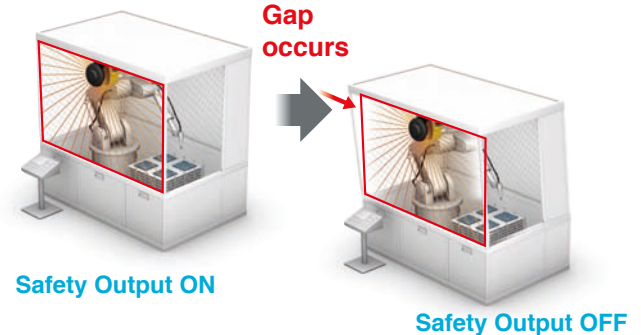

Cable Access Options

To tailor the OS32C to your installation, two options are available for the location of the power and ethernet connections:

OS32C-BP(-4M)/OS32C-BP-DM(-4M) (Cable access from the back) OS32C-SP1(-4M)/OS32C-SP1-DM(-4M) (Cable access from the left side) These can be selected according to the needs of AGV or facilities design.



OS32C with cable access from the back (OS32C-BP(-4M)/OS32C-BP-DM(-4M))



OS32C with cable access from the left side (OS32C-SP1(-4M)/OS32C-SP1-DM(-4M))

Easy configuration of complex zones

The configuration of the safety zone and warning zones can be done in real time using a PC. Configurations can also be created or modified offline.

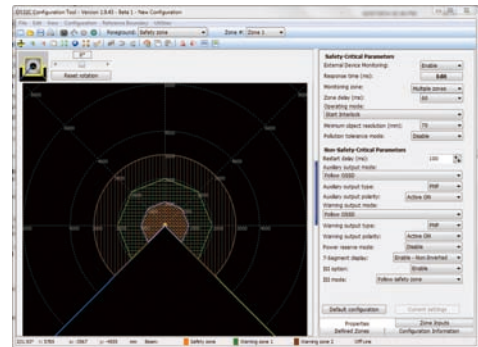

EtherNet/IP™ for Status and Measurement Data

The OS32C system status, zone status, and measurement data can all be monitored over EtherNet/IP.

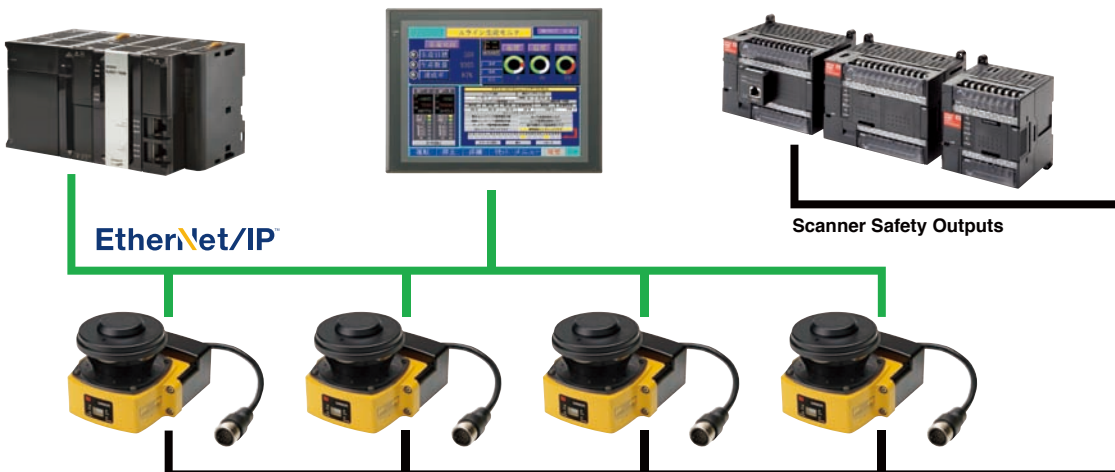

EtherNet/IP™ is the trademarks of ODVA.

Windows is registered trademarks of Microsoft Corporation in the USA and other countries.

Other company names and product names in this document are the trademarks or registered trademarks of their respective companies.

Microsoft product screen shot(s) reprinted with permission from Microsoft Corporation.

Applications

Intrusion Detection

Reference Boundary Monitoring function supports intrusion detection without physically blocking the entrance. Supports various operation patterns by switching zone sets.

Arm detection can also be made possible by changing the minimum object resolution to 30, 40, 50 or 70 mm through use of the configuration tool. However, the maximum size of the safety zone varies depending on the configured minimum object resolution.

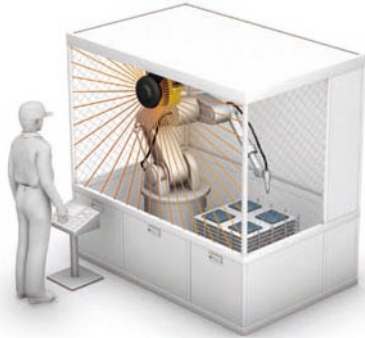

Intrusion detection with vertical installation

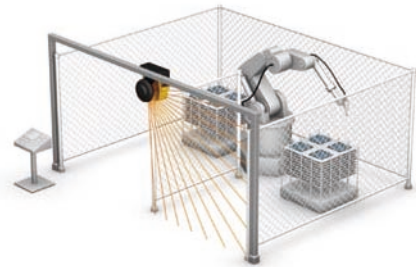

Safety zone can be selected

Collision Avoidance

Small, light and compact body provides for easy installation on an AGV.

Low power consumption (5 W) reduces battery load on the AGV. (3.75 W in standby mode)

Up to 70 zone set combinations support complex AGV tracks.

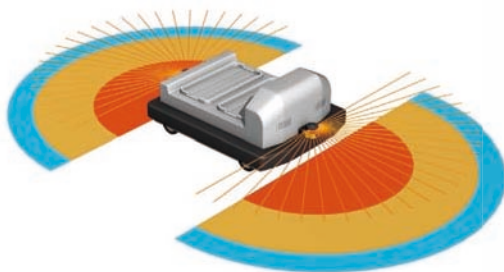

Front/Rear monitoring

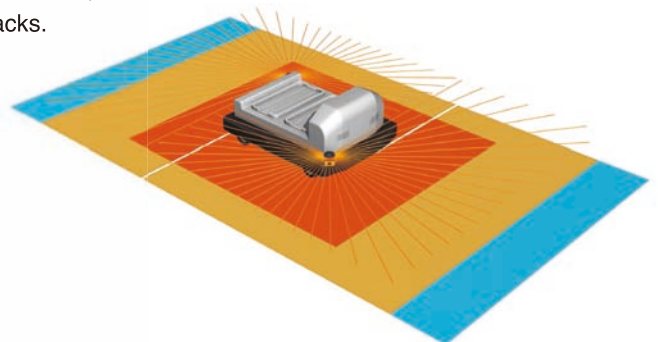

All-around Monitoring

Presence Detection

Compact body allows for use inside the machine.

Detection angle of 270° provides coverage of two sides with one scanner.



Guarding inside the machine

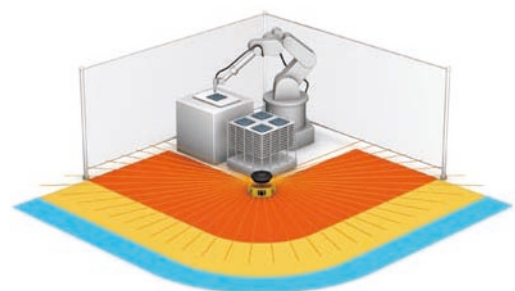

Presence detection of 270°

Safety Laser Scanner OS32C

Compact (104.5 mm), lightweight (1.3 kg) and easy-to-install Safety Laser Scanner



- Provides a safety circuit of PLd/Safety Category 3 (ISO13849-1) without a dedicated controller.
- Type 3 Safety Laser Scanner complies with IEC61496-1/-3.
- 70 sets of safety zone and warning zone combinations are available, supporting complicated changes in working environments.
- A safety radius up to 4 m and warning zone(s) radius up to 15 m can be set.
- The minimum object resolution can be changed to 30, 40, 50 or 70 mm.
- The response time is configurable from 80 ms to a maximum of 680 ms.
- Reference Boundary Monitoring function prevents unauthorized changes in the scanner position.
- Minimal down time, sensor block can be replaced without the need to reprogram.



Refer to "Safety Precautions" on page 20.

For the most recent information on models that have been certified for safety standards, refer to your OMRON website.

Ordering Information

OS32C (Power cable is sold separately.)

Appearance	Description	Max. Operating Range (Safety Zone)	Model	Remarks
	OS32C with back location cable entry	3m	OS32C-BP VER2	CD-ROM (Configuration tool) OS supported: Windows XP (32-bit version, Service Pack 3 or later) Windows 7 (32-bit version/64-bit version), Windows 8.1 (32-bit version/64-bit version), Windows 10 (32-bit version/64-bit version) For configuration tool version, refer to page 23.
		4m	OS32C-BP-4M <i>NEW</i>	
	OS32C with side location cable entry *	3m	OS32C-SP1 VER2	
		4m	OS32C-SP1-4M <i>NEW</i>	
	OS32C with EtherNet/IP and back location cable entry	3m	OS32C-BP-DM	
		4m	OS32C-BP-DM-4M <i>NEW</i>	
	OS32C with EtherNet/IP and side location cable entry *	3m	OS32C-SP1-DM	
		4m	OS32C-SP1-DM-4M <i>NEW</i>	

* For OS32C-SP1(-DM), each connector is located on the left as viewed from the back of the I/O block.

Power Cable





Appearance	Description	Model	Remarks
	Cable length: 3 m	OS32C-CBL-03M	One cable is required per sensor.
	Cable length: 10 m	OS32C-CBL-10M	
	Cable length: 20 m	OS32C-CBL-20M	
	Cable length: 30 m	OS32C-CBL-30M	

Ethernet Cable

Appearance	Description	Model	Remarks
	Cable length: 2 m	OS32C-ECBL-02M	Required for configuration and monitoring.
	Cable length: 5 m	OS32C-ECBL-05M	
	Cable length: 15 m	OS32C-ECBL-15M	

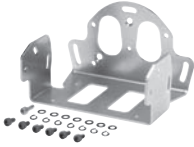



Note: An ethernet cable with an M12, 4-pin connector is required.

Mounting Brackets

Appearance	Description	Model	Remarks
	Bottom/side mounting bracket	OS32C-BKT1	Bottom/side mounting bracket x 1, unit mounting screws x 4 sets
	XY axis rotation mounting bracket	OS32C-BKT2	XY axis rotation mounting bracket x 1, unit mounting screws x 6 sets, bracket mounting screws x 1 set (must be used with OS32C-BKT1)
	Simple mounting bracket	OS32C-BKT3	Simple mounting brackets x 2, unit mounting screws x 4 sets *
	Protective cover for window	OS32C-BKT4	
	Mounting stand	OS32C-MT	When using a mounting stand, use an OS32C with side location cable entry (OS32C-SP1(-DM)). The OS32C with back location cable entry (OS32C-BP(-DM)) cannot be mounted. Use with mounting brackets (OS32C-BKT1 and OS32C-BKT2).
	Hardware kit for mounting stand	OS32C-HDT	Mounting screws x 3 sets Use this when mounting a bracket to the mounting stand.

* There are eight OS32C mounting screws: four screws for singular use, and four screws for protective cover for window.

Accessories

Appearance	Description		Model	Remarks
	Scan window		OS32C-WIN-KT	Spare for replacement
	Sensor block without I/O block Max. Operating Range: 3 m		OS32C-SN *	Spare for replacement
	Sensor block without I/O block Max. Operating Range: 4 m		OS32C-SN-4M	
	Sensor block without I/O block for EtherNet/IP Max. Operating Range: 3 m		OS32C-SN-DM	Spare replacement for EtherNet/IP
	Sensor block without I/O block for EtherNet/IP Max. Operating Range: 4 m		OS32C-SN-DM-4M	
	I/O block	With cable access from the back	OS32C-CBBP	Spare for replacement
		With cable access from the left side	OS32C-CBSP1	Spare for replacement

* When ordering, add "VER2" to the end of the model number. (OS32C-SN VER2)

Rating/Performance

Sensor Type		Type 3 Safety Laser Scanner
Performance Level (PL)/ Safety Category		PLd/Safety Category 3 (ISO 13849-1)
Functional Safety of Electrical/ Electronic/Programmable Electronic Safety-related Systems		SIL 2, PFH _D = 8.3 × 10 ⁻⁸ (IEC61508)
Detection Capability		Configurable; Non-transparent with a diameter of 30, 40, 50, 70mm (1.8% reflectivity or greater) (default: 70 mm)
Monitoring Zone		Monitoring Zone Set Count: (Safety Zone + 2 Warning Zones) x 70 sets
Operating Range	OS32C-□□□□	Safety Zone: 1.75 m (min. obj. resolution of 30 mm) 2.5 m (min. obj. resolution of 40 mm) 3.0 m (min. obj. resolution of 50 mm or 70 mm) Warning Zone: 10.0 m
	OS32C-□□□□-4M	Safety Zone: 1.75 m (min. object resolution of 30mm) 2.5 m (min. object resolution of 40 mm) 3.0 m (min. object resolution of 50 mm) 4.0 m (min. object resolution of 70 mm) Warning Zone: 15.0 m
Maximum Measurement Error		100 mm (at range of 3 m or less) *1 110 mm (at distance greater than 3 m and up to 4m) *1
Detection Angle		270°
Angular Resolution		0.4°
Laser Beam Diameter		6 mm at optics cover, 14 mm (typical) at 3 m.
Laser Scan Plane Height		67mm from the bottom of the scanner (see "External Dimensional Drawings" on page 15 for more detail.)
Response Time		Response time from ON to OFF: From 80 ms (2 scans) to 680 ms (up to 17 scans) *8 Response time from OFF to ON: Response time from ON to OFF + 100 ms to 60 s (Configurable)
Zone Switching Time		20 to 320 ms
Line Voltage		24 VDC +25%/-30% (ripple p-p 2.5 V max.) *2
Power Consumption		Normal operation: 5 W max., 4 W typical (without output load) *3 Standby mode: 3.75 W (without output load)
Emission Source (Wavelength)		Infrared Laser Diode (905 nm)
Laser Protection Class		Class 1: IEC/EN60825-1 Class 1: JIS C 6802 Class I: CFR21 1040.10, 1040.11
Safety Output (OSSD)		PNP transistor x 2, load current of 250 mA max., residual voltage of 2 V max., load capacity of 2.2 μF max., leak current of 1 mA max. *3, *4, *5
Auxiliary Output (Non-Safety)		NPN/PNP transistor x 1, load current of 100 mA max., residual voltage of 2 V max., leak current of 1 mA max. *4, *5, *7
Warning Output (Non-Safety)		NPN/PNP transistor x 1, load current of 100 mA max., residual voltage of 2 V max., leak current of 1 mA max. *4, *5, *7
Operation Mode		Auto Start, Start Interlock, Start/Restart Interlock
Input	External Device Monitoring (EDM)	ON: 0 V short (input current of 50 mA), OFF: Open
	Start	ON: 0 V short (input current of 20 mA), OFF: Open
	Zone Select	ON: 24 V short (input current of 5 mA), OFF: Open
	Stand-by	ON: 24 V short (input current of 5 mA max.), OFF: Open
Connection Type		Power Cable: 18-pin mini-connector (pigtail) Communication Cable: M12, 4-pin connector
Connection with PC		Communication: Ethernet *6 OS Supported: Windows XP (32-bit version, Service Pack 3 or later), Windows 7 (32-bit version/64-bit version), Windows 8.1 (32-bit version/64-bit version), Windows 10 (32-bit version/64-bit version)
Indicators		RUN indicator: Green, STOP indicator: Red, Interlock Indicator: Yellow, Warning Output Indicator: Orange Status/Diagnostic Display: 2 x 7-segment LEDs, Individual Sector Indicators: Red LED x 8
Protective Circuit		Protection against output load short and reverse power connection
Ambient Temperature		Operation: -10 to 50 °C, Storage: -25 to 70 °C
Ambient Humidity		Operation & Storage: 95% RH max., non-condensing
Ambient Operation Illumination		Incandescent lamp: Illumination on receiving surface 1500 lx max. (an angle of laser scanning plane and disturbance light must be +/-5 degrees or more)
Insulation Resistance		20 MΩ or higher (500 VDC)
Dielectric Withstand Voltage		350VDC, 1 minute
Enclosure Rating		IP65 (IEC60529)
Enclosure		Sensor head: Die-cast aluminum, optical cover: Polycarbonate, I/O block: Die-cast aluminum
Dimensions (WxHxD)		133.0 x 104.5 x 142.7 mm (except cable)

OS32C

Impact Resistance	98 m/s ² 1,000 times for each of X, Y, and Z directions (IEC60068-2-29)
Vibration	10 to 55 Hz double-amplitude of 0.7 mm, 20 sweepings for X, Y, and Z directions (IEC60068-2-6)
Weight (Main Unit only)	1.3 kg
Power Cable	Up to 30 m
Communication Cable	Up to 100 m for 100BASE-TX cable *9
Approvals	Certificated by: TÜV Rheinland, UL Standards: EN61496-1 (Type 3 ESPE), EN61496-3 (Type 3 AOPDDR), EN61508 (SIL2), IEC61496-1 (Type 3 ESPE), IEC61496-3 (Type 3 AOPDDR), IEC61508 (SIL2), UL508, UL1998, CAN/CSA-C22.2 No. 14, CAN/CSA-C22.2 No. 0.8

- *1. An additional measurement error may need to be added due to reflective backgrounds.
- *2. For power source specification, refer to “*Safety Precautions*” on page 20.
- *3. Rated current of OS32C is 1.025 A max. (OS32C 210 mA + OSSD A load + OSSD B load + Auxiliary output load + Warning output load + Functional Inputs).
Where functional inputs are: EDM input ... 50 mA Start input ... 20 mA Standby input ... 5 mA Zone X input ... 5 mA x 8 (eight zone set select inputs)
- *4. Output voltage is Input voltage - 2.0 VDC.
- *5. Total consumption current of 2 OSSDs, auxiliary output, and warning output must not exceed 700 mA.
- *6. An ethernet cable with an M12, 4-pin connector is required.
- *7. Output polarity (NPN/PNP) is configurable via the configuration tool.
- *8. Pollution Tolerance mode will add 6 ms to each scan time.
- *9. Omron only supplies up to a 15 m Ethernet cable. For longer lengths a connection to a network switch/router is needed.

Connection

Basic connection with single OS32C unit

Highest achievable PL/ safety category	Model	Stop category	Reset
PLd/3 equivalent	Safety Laser Scanner OS32C Forced Guided Relay G7SA	0	Manual

Note: The above PL is only the evaluation result of the example. The PL must be evaluated in an actual application by the customer after confirming the usage conditions.

Application Overview

- The power supply to the motor M is turned OFF when an intrusion is detected in the safety zone.
- The power supply to the motor M is kept OFF until the start input is pressed after the safety zone is clear.

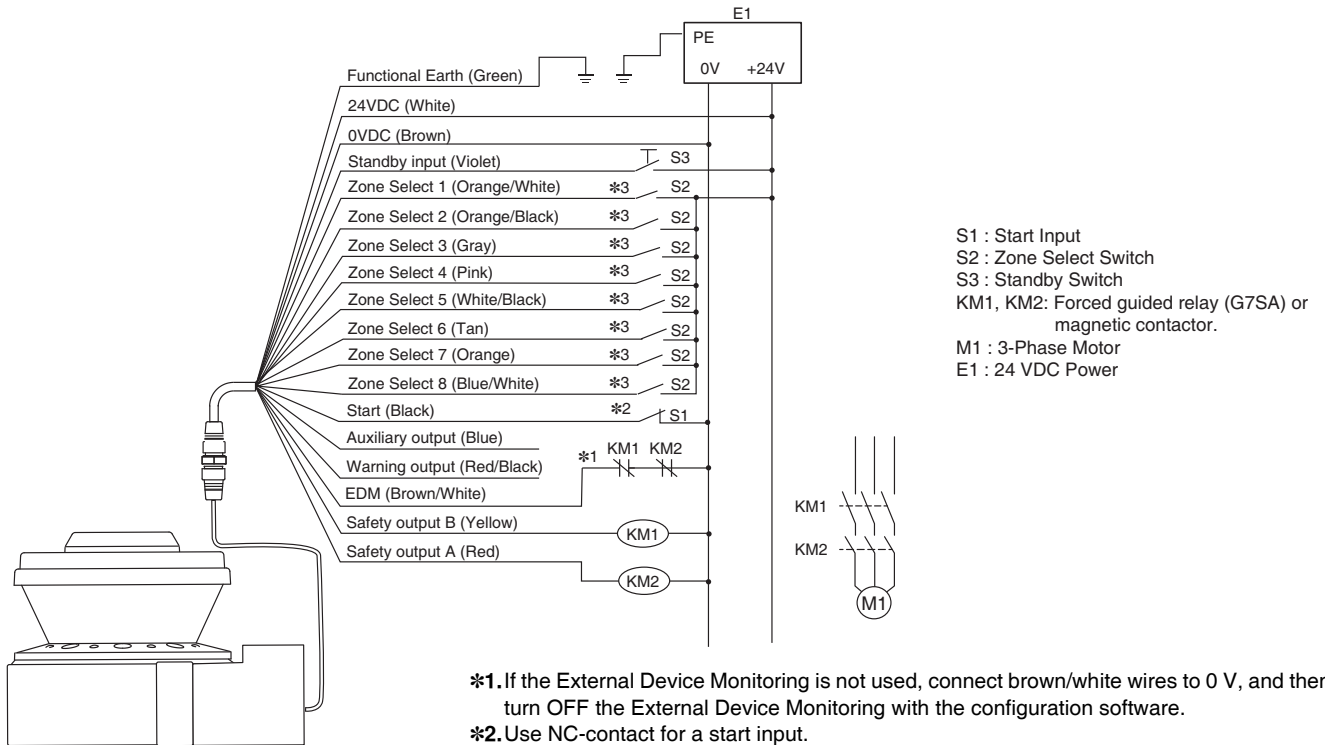

S1 : Start Input
 S2 : Zone Select Switch
 S3 : Standby Switch
 KM1, KM2: Forced guided relay (G7SA) or magnetic contactor.
 M1 : 3-Phase Motor
 E1 : 24 VDC Power

- *1. If the External Device Monitoring is not used, connect brown/white wires to 0 V, and then turn OFF the External Device Monitoring with the configuration software.
- *2. Use NC-contact for a start input.
- *3. For zone select switch setting, refer to OS32C Series User's Manual (Man.No.Z296-E1). When using only one zone, no connection is needed for the zone select inputs.

OS32C Configuration
 - External Device Monitoring Enabled
 - Start/Restart Interlock

Connecting to AGV Controls

Highest achievable PL/ safety category	Model	Stop category	Reset
PLd/3 equivalent	Safety Laser Scanner OS32C	1	Auto

The circuit configuration of the stop/deceleration control must meet the requirements of category 3.

Note: The above PL is only the evaluation result of the example. The PL must be evaluated in an actual application by the customer after confirming the usage conditions.

Application Overview

- Stop/deceleration is performed when an intrusion is detected in the safety zone.
- Stop/deceleration is released when the safety zone is clear.

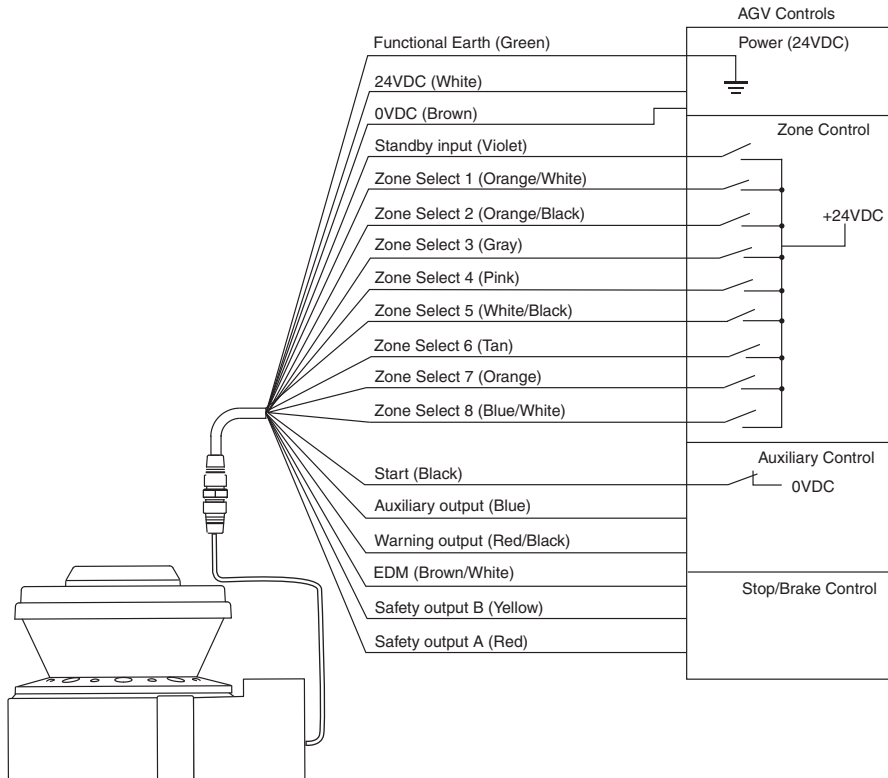

OS32C Configuration
 - External Device Monitoring Disabled
 - Automatic Start

Connecting to the Controller G9SA-301

Highest achievable PL/ safety category	Model	Stop category	Reset
PLd/3 equivalent	Safety Laser Scanner OS32C Safety Relay Unit G9SA-301 Forced Guided Relay G7SA	0	Auto

Note: The above PL is only the evaluation result of the example. The PL must be evaluated in an actual application by the customer after confirming the usage conditions.

Application Overview

- The power supply to the motor M is turned OFF when an intrusion is detected in the safety zone.
- The power supply to the motor M is kept OFF until the safety zone is clear.

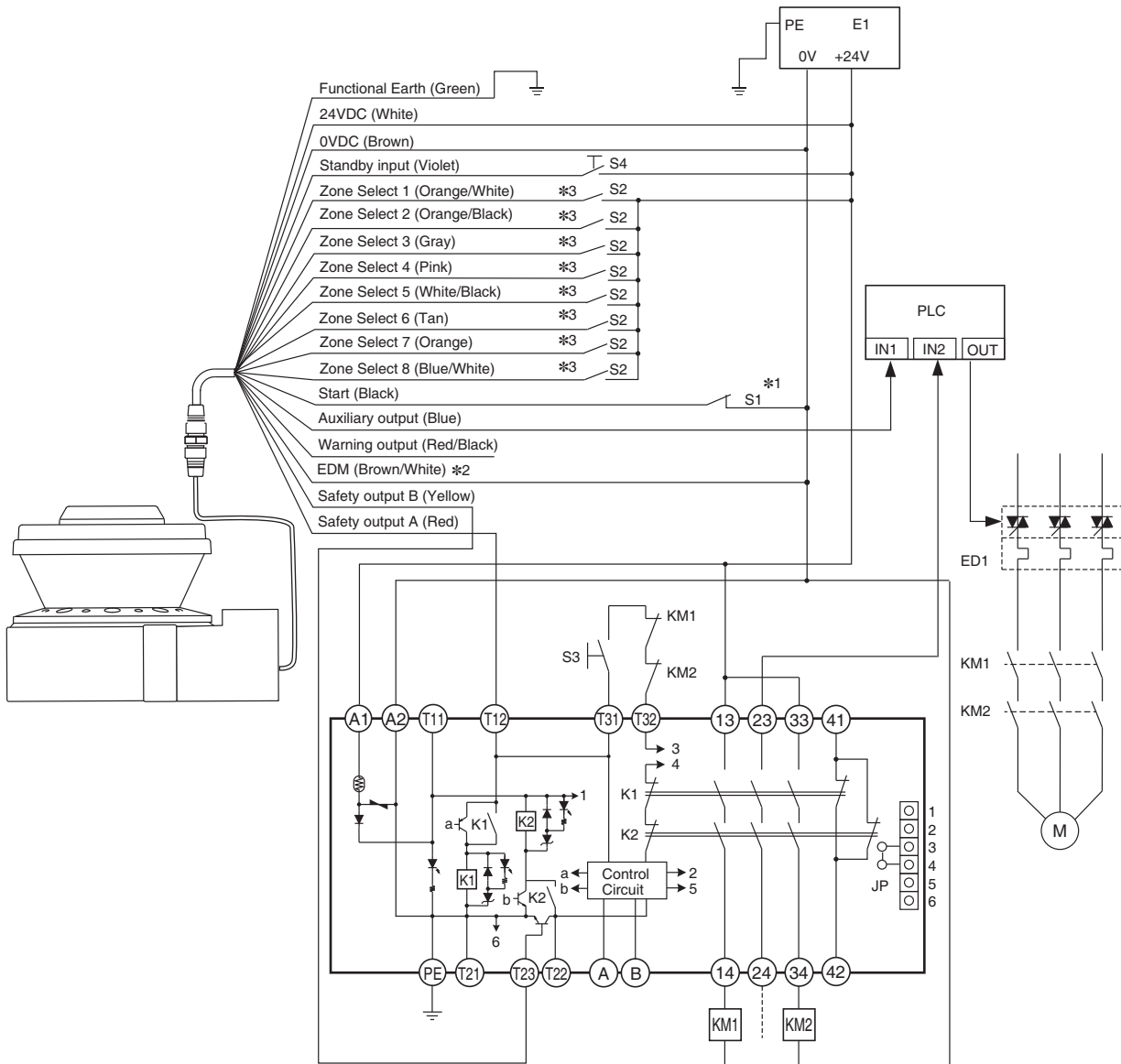

KM1, KM2: Forced guided relay (G7SA) or magnetic contactor.
 ED1: Solid state contactor (G3J)
 M : 3-Phase Motor
 S1 : Start Input (use for releasing lockout)
 S2 : Zone Select Switch
 S3 : Reset Switch
 S4 : Standby Switch
 E1 : 24 VDC Power
 PLC : Programmable Controller (This is for monitoring only and unrelated to a safety system)

Note: Reset setting are below.

OS32C: Automatic start, G9SA-301: Manual reset

*1. Use NC-contact for a start input.

*2. If the External Device Monitoring is not used, connect brown/white wires to 0V, and then turn OFF the External Device Monitoring with the configuration software.

*3. For zone select switch setting, refer to OS32C Series User's Manual (Man.No.Z296-E1). When using only one zone, no connection is needed for the zone select inputs.

OS32C

System Components and Functions

Main Unit

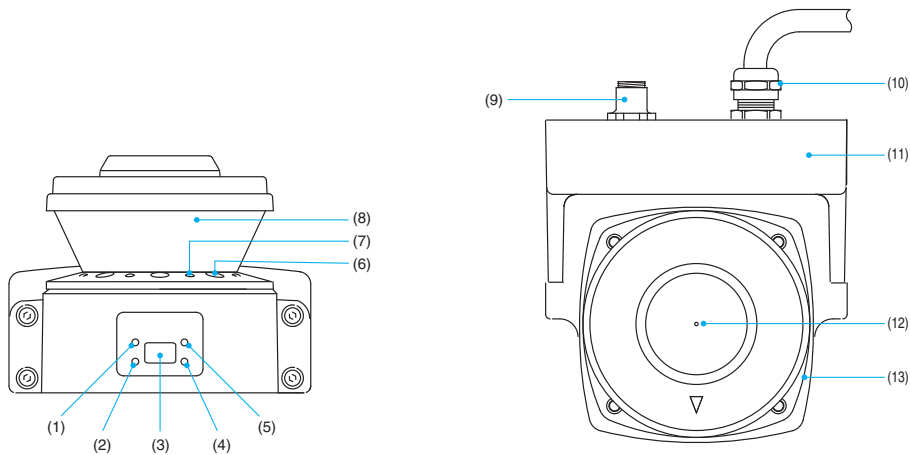

Number	Component	Function
(1)	RUN indicator (green)	Will turn ON when safety zone is clear and OSSDs are ON.
(2)	Interlock Indicator (yellow)	Will turn ON when in interlock state, blink under lockout (@ 1 Hz), and blink under configuration (@ 4 Hz).
(3)	Status/Diagnostic Display	The scanner status, configuration/operation, or failure is displayed.
(4)	Warning Output Indicator (orange)	Will turn ON when the warning output is ON and will flash when dust or contamination is detected on the scan window (@ 1 Hz).
(5)	STOP indicator (red)	Will turn ON when safety zone is blocked, OSSD are OFF or under interlock state.
(6)	Dust Ring	Dust detection cover with reflective surface, for dust accumulation detection
(7)	Individual Sector Indicators (ISI)	Will turn ON when an intrusion is detected in the safety zone (default), 8 sectors total. Each sector = 33.75°. Will flash when dust or contamination is detected on the scan window.
(8)	Scan window	The window where the laser light is emitted and received.
(9)	Ethernet Connector	Used for Ethernet cable connection. *
(10)	Power Connector	18-pin connector (pigtail). *
(11)	I/O Block	Connector module
(12)	Center of rotation	Indicates the location of the axis around which the laser emits.
(13)	Sensor block	Sensor head; field replaceable.

* For OS32C-SP1(-DM), each connector is located on the left as viewed from the back of the I/O block.

Status/Diagnostic Display

When powered up, the OS32C will display the configured minimum object resolution for 5 seconds, as indicated in the following table:

Digital Indication	Minimum object resolution
L3	30 mm
L4	40 mm
L5	50 mm
L7	70 mm (factory default)

External Dimensional Drawings

(Unit: mm [inch])

OS32C with Back Location Cable Entry/with EtherNet/IP and Back Location Cable Entry

- OS32C-BP
- OS32C-BP-DM
- OS32C-BP-4M
- OS32C-BP-DM-4M

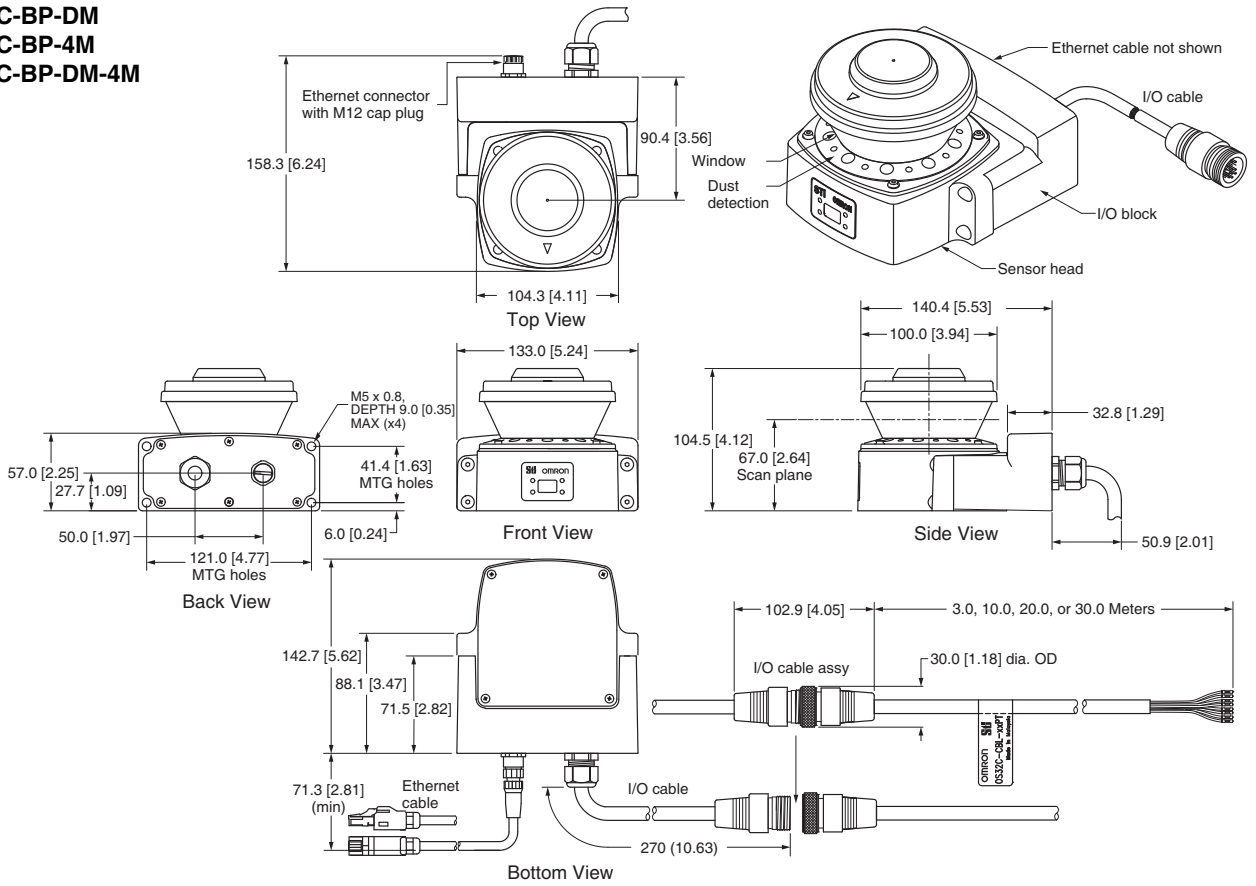

OS32C with Side Location Cable Entry/with EtherNet/IP and Side Location Cable Entry

- OS32C-SP1
- OS32C-SP1-DM
- OS32C-SP1-4M
- OS32C-SP1-DM-4M

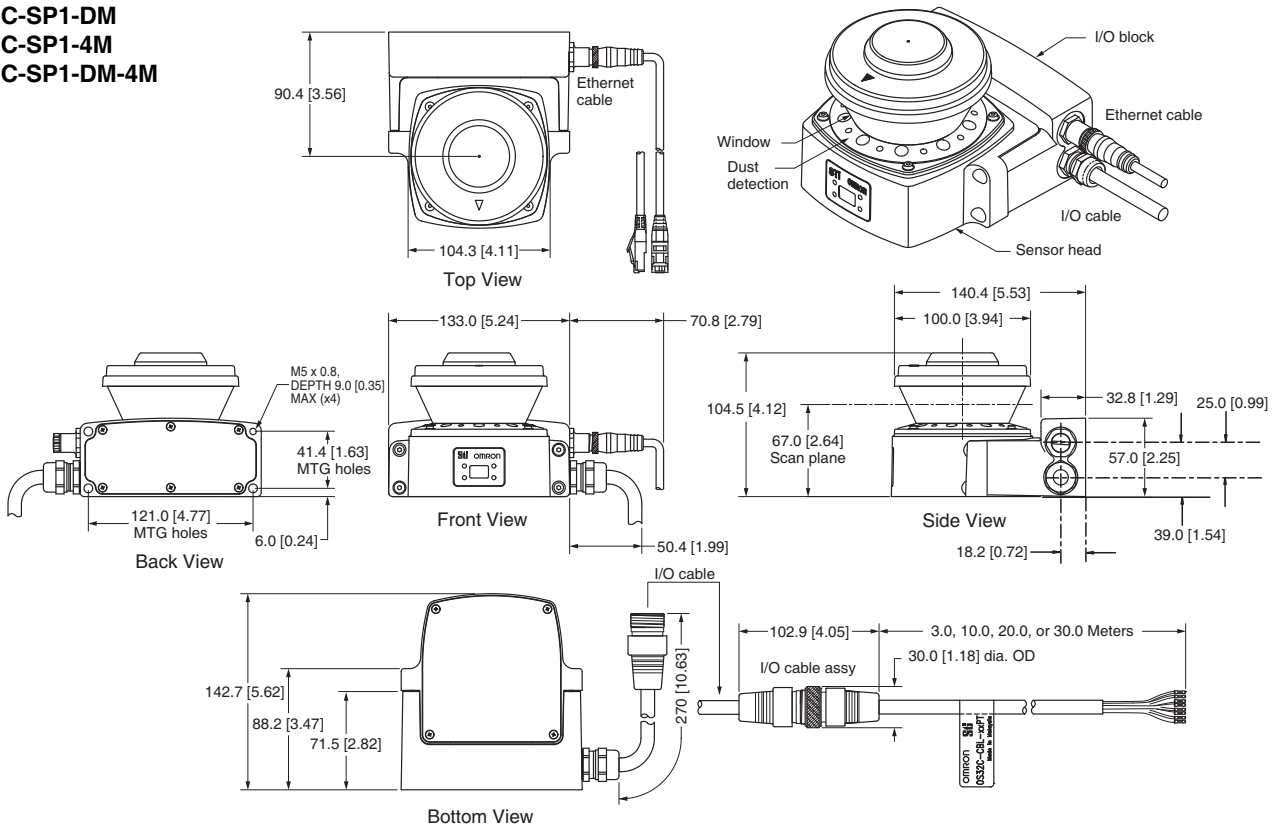

OS32C

OS32C with Top Guard Kit

OS32C-BP/OS32C-BP-DM/OS32C-BP-4M/OS32C-BP-DM-4M
+ OS32C-BKT4

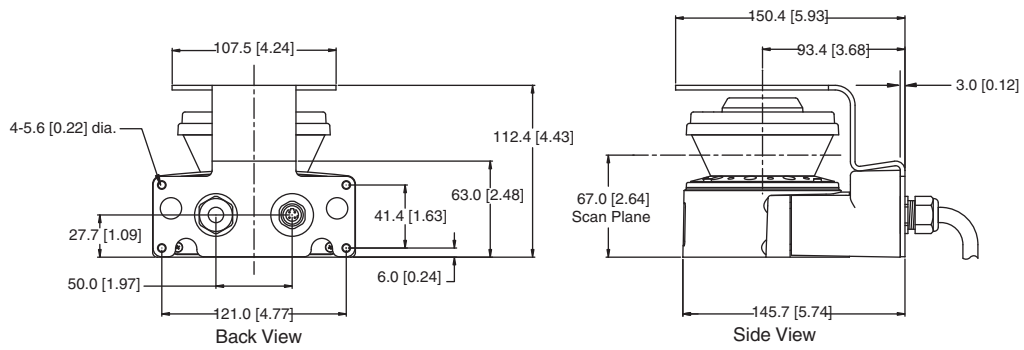

OS32C with Bottom/Side Mounting Brackets

OS32C-BP/OS32C-BP-DM/OS32C-BP-4M/OS32C-BP-DM-4M
+ OS32C-BKT1

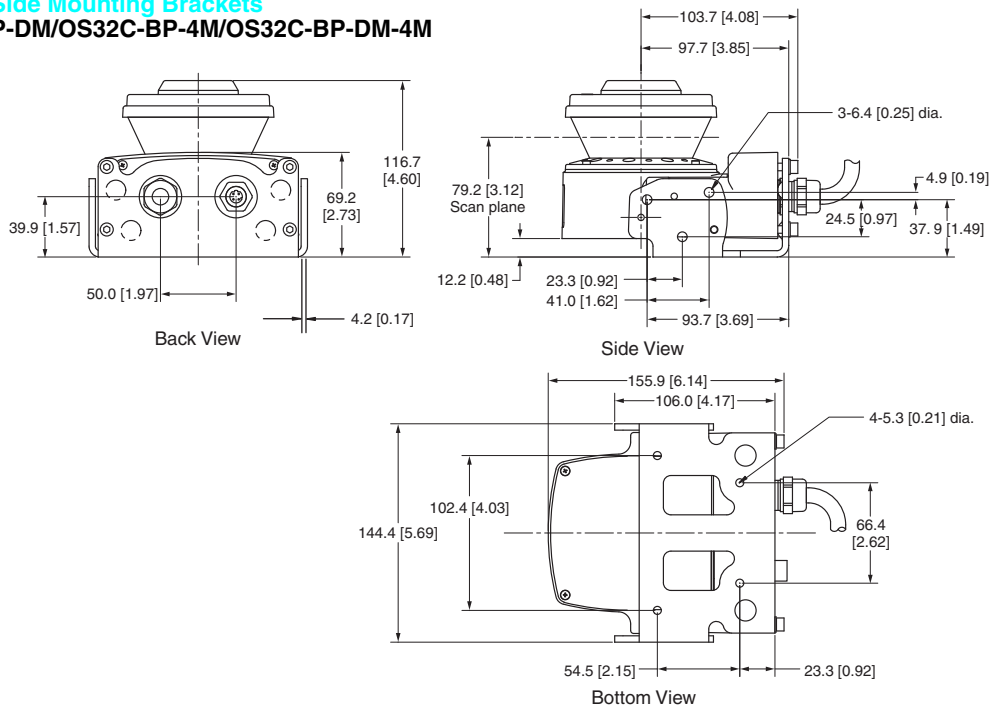

OS32C with Simple Mounting Bracket

OS32C-BP/OS32C-BP-DM/OS32C-BP-4M/OS32C-BP-DM-4M
+ OS32C-BKT3

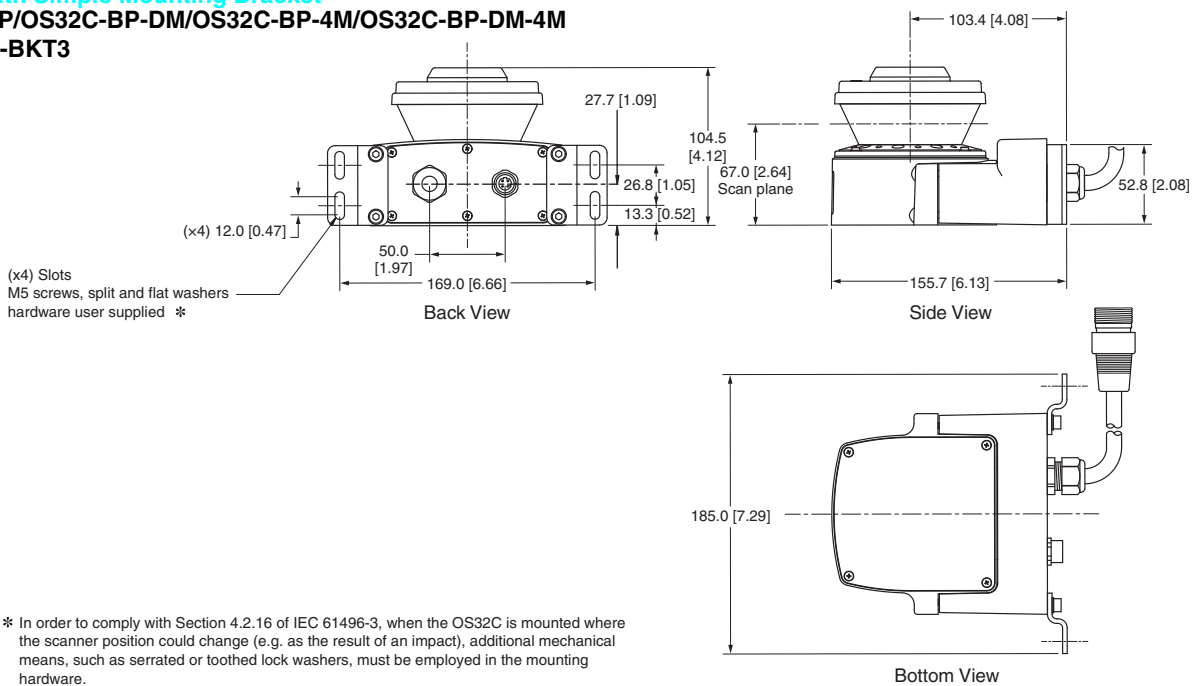

* In order to comply with Section 4.2.16 of IEC 61496-3, when the OS32C is mounted where the scanner position could change (e.g. as the result of an impact), additional mechanical means, such as serrated or toothed lock washers, must be employed in the mounting hardware.

OS32C with Bottom/Side Mounting Brackets and Top Guard Kit

OS32C-BP/OS32C-BP-DM/OS32C-BP-4M/OS32C-BP-DM-4M

+ OS32C-BKT1 + OS32C-BKT4

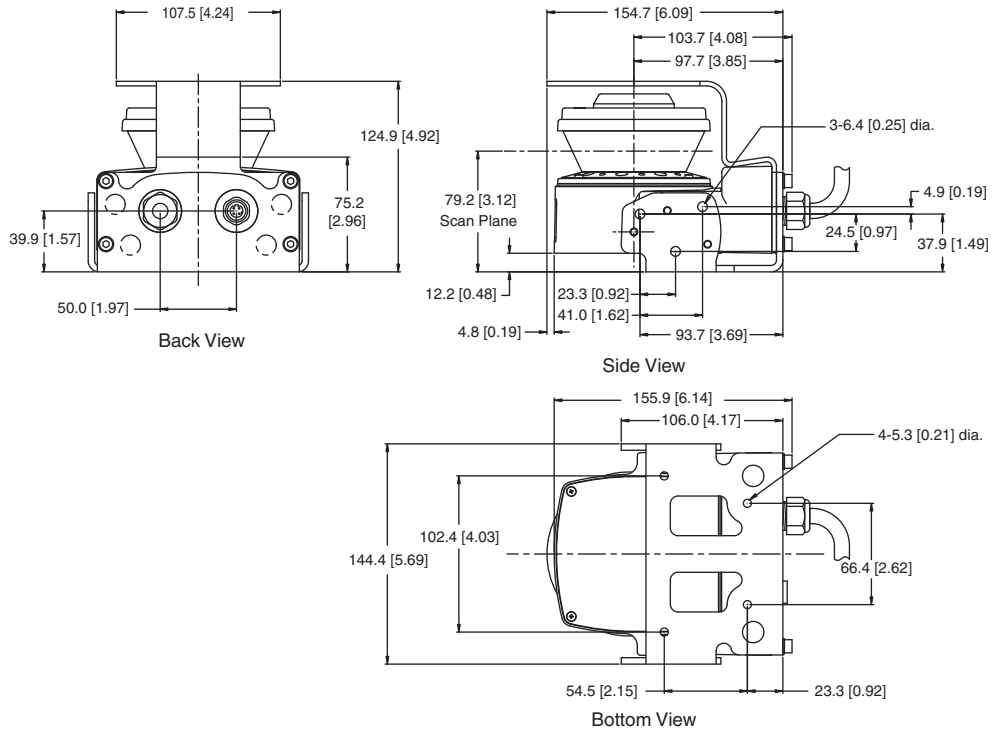

OS32C with Bottom/Side Mounting Brackets and XY Axis Rotation Mounting Kit

OS32C-BP/OS32C-BP-DM/OS32C-BP-4M/OS32C-BP-DM-4M

+ OS32C-BKT1 + OS32C-BKT2

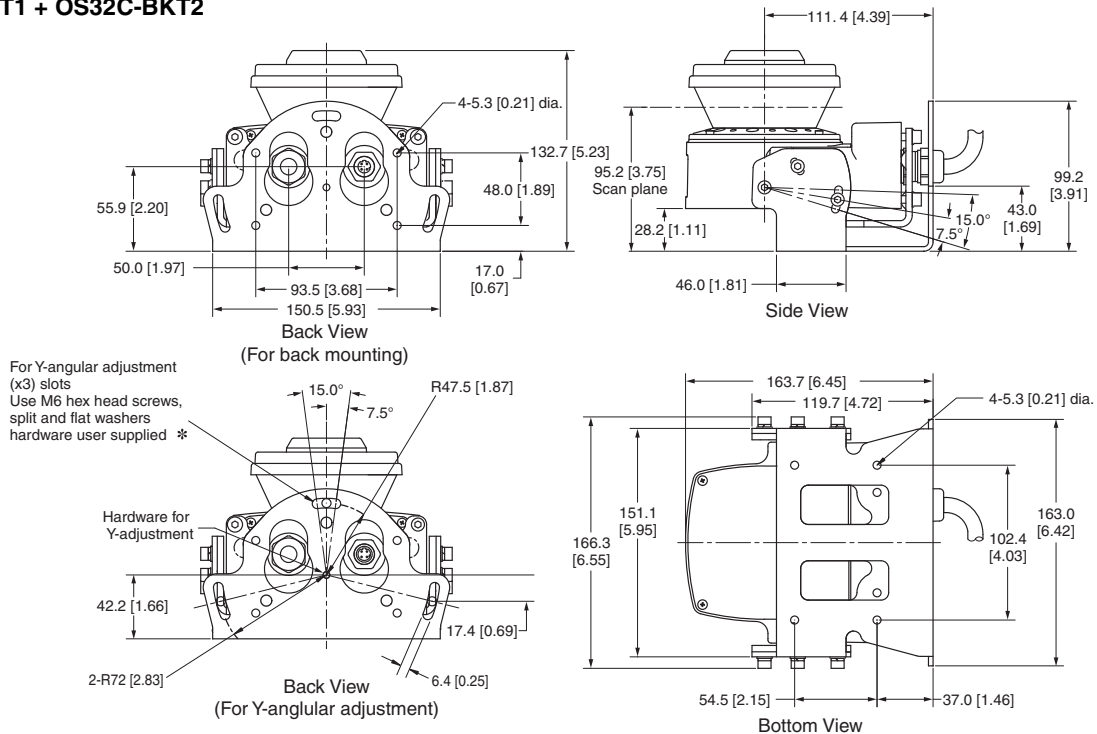

* In order to comply with Section 4.2.16 of IEC 61496-3, when the OS32C is mounted where the scanner position could change (e.g. as the result of an impact), additional mechanical means, such as serrated or toothed lock washers, must be employed in the mounting hardware.

OS32C

OS32C with Bottom/Side Mounting Brackets, XY Axis Rotation Mounting Kit and Top Guard Kit

OS32C-BP/OS32C-BP-DM/OS32C-BP-4M/OS32C-BP-DM-4M

+ OS32C-BKT1 + OC32C-BKT2 + OS32C-BKT4

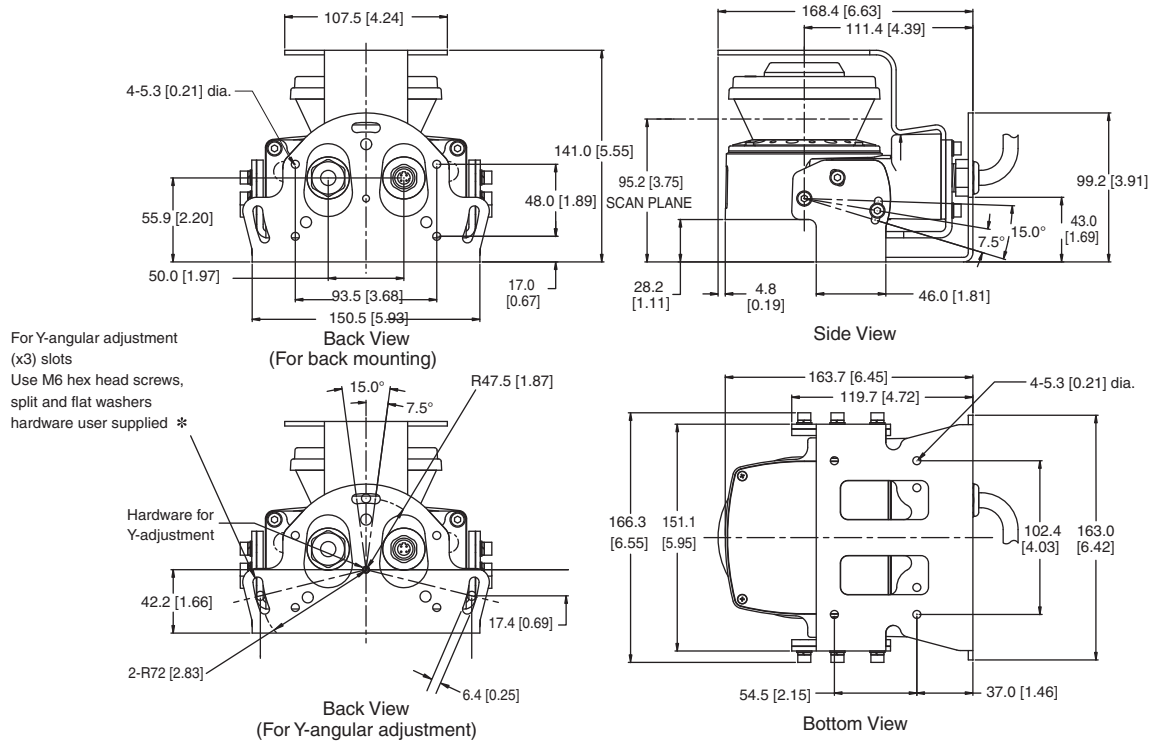

* In order to comply with Section 4.2.16 of IEC 61496-3, when the OS32C is mounted where the scanner position could change (e.g. as the result of an impact), additional mechanical means, such as serrated or toothed lock washers, must be employed in the mounting hardware.

OS32C with Bottom/Side Mounting Brackets, XY Axis Rotation Mounting Kit, Mounting Stand and Mounting Stand Hardware Kit

OS32C-SP1/OS32C-SP1-DM/OS32C-BP-4M/OS32C-BP-DM-4M

+ OS32C-BKT1 + OS32C-BKT2 + OS32C-MT + OS32C-HDT

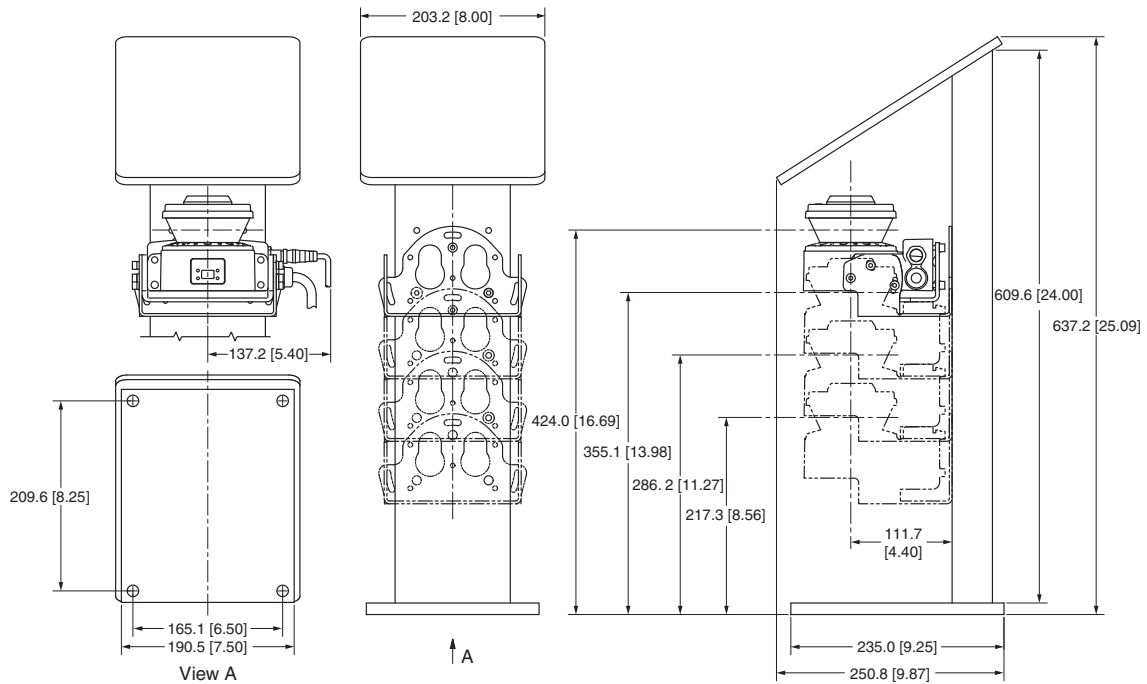

Power Cable
OS32C-CBL-□□M

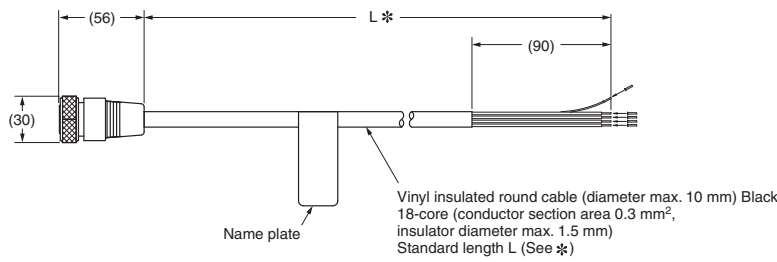

* Sizes are as below

Model Number	L
OS32C-CBL-03M	3 m
OS32C-CBL-10M	10 m
OS32C-CBL-20M	20 m
OS32C-CBL-30M	30 m

Ethernet Cable
OS32C-ECBL-□□M

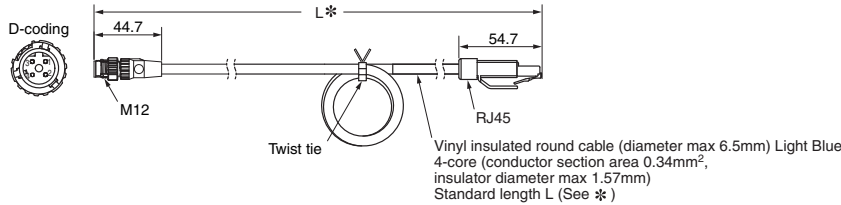

* Sizes are as below

Model Number	L
OS32C-ECBL-02M	2 m
OS32C-ECBL-05M	5 m
OS32C-ECBL-15M	15 m

Safety Precautions

Description shown below is only a guideline to choose a safety laser scanner.

To use the product properly, you must read the instruction manual that comes with the product.

Legislation and Standards

1. Application of an OS32C sensor by itself cannot receive the type approval provided by Article 44-2 of the Labor Safety and Health Law of Japan. It is necessary to apply it as a system. Therefore, when using this product in Japan as a "safety system for presses and shearing machines" as prescribed in Article 42 of the Labor Safety and Health Law, the complete system must receive the type approval.

2. (1) This product is electro-sensitive protective equipment (ESPE) in accordance with European Union (EU) Machinery Directive Annex V, Item 2.

(2) This product complies with the following legislation and standards:

- 1) EU legislation
 - Machinery Directive 2006/42/EC
 - EMC Directive 2014/30/EU
 - RoHS Directive (2011/65/EC)
- 2) European & International Standards
 - EN 61496-1 (Type 3 ESPE)
 - EN 62061
 - EN 50178
 - EN ISO 13849-1
 - IEC 61496-3 (Type 3 AOPDDR)
 - IEC 61508, Parts 1-7 (SIL-2)
 - EN 60204-1
- 3) North American Standards: per UL File E241445, US and C-UL approvals (CNN: NIPM/NIPM7).
 - ANSI/UL 508 (Industrial Control Equipment)
 - ANSI B11.19
 - ANSI/RIA R15.06
 - NFPA 79
 - Code of Federal Regulations CFR29
 - IEC 61496-1 (Type 3 ESPE)
 - IEC 61496-3 (Type 3 AOPDDR)
 - UL 1998 (Software in Programmable Components)
 - IEC 61508 (Functional Safety of Electrical/Electronic/Programmable Electronic Safety-Related Systems)
 - IEC 61508-3 (Functional Safety of Electrical/Electronic/Programmable Electronic Safety-Related Systems - Part 3: Software Requirements)

- CAN/CSA-C22.2 No. 14 (Industrial Control Equipment)
- CAN/CSA-C22.2 No. 0.8 (Safety Functions Incorporating Electronic Technology)
- 4) JIS standards
 - JIS B 9704-1
 - JIS B 9704-3 (Type3 ESPE)
- (3) This product received the following approvals from TÜV Rheinland of the EU.
 - EC Type-Examination in accordance with the EU Machinery Directive,
 - Type 3 ESPE (IEC61496-1),
 - Type 3 AOPDDR (IEC61496-3)

Safety Precautions



The Alert symbols and their meanings ensure safe use of the products

In order to use the OS32C safely, the precautions listed in this manual are indicated by alert symbols. The descriptions must be followed, failure to follow all precautions and alerts may result in an unsafe installation or operation. The following indications and symbols are used.

	WARNING	Indicates a potentially hazardous situation which, if not avoided, will result in minor or moderate injury, or may result in serious injury or death. Additionally there may be significant property damage.
	CAUTION	Indicates a potentially hazardous situation which, if not avoided, will result in minor or moderate injury, or there may be property damage.

OS32C

Meanings of Alert Symbols

	Indicates prohibited actions.
	Indicates mandatory actions.

WARNING

An OS32C is an electro-sensitive protective equipment designed to guard personnel working around hazardous machinery. 

Whether a specific machine application and the OS32C system installation complies with safety regulations depends on the proper application, installation, maintenance and operation of the OS32C system. These items are the responsibility of the purchaser, installer and user. 

User

WARNING

The administrator is responsible for the selection and training of personnel to properly install, operate, and maintain the machine and its safeguarding systems. 

An OS32C system should only be installed, verified and maintained by a qualified person. A qualified person is defined as “an individual who understands, is trained on, and demonstrates competence with the construction, operation or maintenance of the machinery and the hazards involved.” (ANSI/PMMA B155.1-2006) 

The machine requirements

WARNING

The guarded machine must be able to stop anywhere in its cycle. Do not use an OS32C on a press with a full-revolution clutch. 

The guarded machine must have a consistent stopping time and adequate control mechanisms. 

All safety-related machine control elements must be designed so that an alarm in the control logic or failure of the control circuit does not lead to a failure to danger. 

Do not use the auxiliary output or warning output for safety applications. A human body may not be detected even if a failure of OS32C occurs, resulting in serious injuries. 

Installation

WARNING

The main unit must be securely mounted and its cable connectors must be tightly attached. 

The OS32C must not be mounted behind glass or within a secondary enclosure. Failure to do so will cause a reduction in detection capability, which can cause serious injury or death. 

A start switch to release interlock must be installed where an operator can observe the monitored/guarded zone as a whole and cannot operate the switch within the hazardous zone. 

Per the International standard IEC 61496-3, area scanners used in applications where the angle of approach exceeds +/- 30 degrees with respect to the detection plane, must use reference boundary monitoring (RBM) of the detection zone. 

Make sure to remove any retro-reflector from the field of view of the OS32C when in RBM mode. 

A protective mechanism must be installed to prevent a hazardous condition in the event of a subsequent machine component failure. The OS32C does not protect against ejected flying material. 

Severe smoke and particulate matter may degrade the efficiency of an OS32C, causing it to unexpectedly enter a Machine Stop state. 

Use of mirrors or mirror-like objects in the protection plane must be avoided, as they can hide part of the area to be monitored/guarded. 

Additional guarding may be required to prohibit access to dangerous areas not covered by the OS32C system. 

Perform the test procedure in this document at installation, after maintenance, adjustment, repair or modification to the machine controls, tooling or the OS32C system. Refer to OS32C Series User's Manual (Man.No.Z296-E1). 

Perform only the test and repair procedures outlined in this manual. 

Additional measurement error resulting from reflective backgrounds may need to be added to the measurement error of the OS32C. 

To use the protective function of the OS32C, a safety zone must be properly defined and configured. 

If the response time is changed, re-calculation of the safety distance is required. This may require re-configuration of the safety zones or re-installation of the OS32C. If the safety distance is not appropriate for the application, the machine may not stop before contact with the hazardous part, resulting in serious injuries or death.



The activation of RBM Only mode will increase the response time. This additional time must be taken into consideration when calculating the safety guarding distance.



When using more than one OS32C, mutual interference should be prevented. This may require different scanner positions or physical shields to be installed.



To ensure a protection degree of IP65, DO NOT use this product without proper sealing of the cable connector, I/O block, and scan window.



If the external zone switching device momentarily exceeds the configured number of active zone set select inputs during the zone switch, an additional Zone Delay may be incurred in the event that wiring of a zone set select input fails. The external zone switching device must properly sequence so the configured number of active inputs is not exceeded in order to guarantee that failed zone set select input wiring will be detected within the normal Zone Switching Time described below.



If an insufficient Zone Delay is used for the actual worst case switching time of the installation, the scanner might start monitoring the wrong zone during the switching period. Also, if an insufficient Zone Delay is used for the actual worst case switching time of the installation, there might be a fault condition during the zone switching period.



If t_{start} (switching start time) is configured without consideration of $T_{maxReaction}$ (total maximum reaction time), object detection within the new safety zone after switching and turning OFF of the safety outputs may be delayed.



Monitoring zone parameters are subject to a number of constraints that include projective consistency, maximum radius, and angle limits. As a result, an imported zone may not correspond exactly to the zone defined in the file. The user must visually verify the imported zone when the zone coordinate import process is complete. Refer to Checkout and Test Procedure Log on OS32C Series User's Manual (Man.No.Z296-E1)



The installer is responsible for assessing the risk and to ensure that the zone of limited detection does not create a safety hazard. If a hazard exists additional countermeasure must be taken, this may require additional guarding measures.



Wiring connections

WARNING

Do not connect the OS32C to a power supply with more than 24VDC + 25% / -30%. Do not supply AC power to the OS32C, this may result in electrical shock.



For the OS32C to meet IEC 61496-1 and UL 508, its DC power supply unit must satisfy all of the following conditions:



- Within rated line voltage (24 VDC +25% / -30%)
- Complying with EMC directives (industrial environments)
- Double-insulation or reinforced insulation between primary and secondary circuits
- Automatic return for overcurrent protection
- Output retention time of 20 ms or longer
- Satisfying output characteristics requirements of Class 2 circuit or limited voltage/current circuit defined in UL508.
- Power supply complying with regulations and standards of EMC and safety of electrical equipment in a country or a region where OS32C is used. (Example: In EU, a power supply must comply with EMC directives and the Low Voltage Directive)

To prevent electrical shock, use double-insulation or reinforced insulation from hazardous voltage (such as 230 VAC).



Cable extensions must be within the specified lengths, otherwise it may result in a failure of the safety functions.



To use this product for a category 3 safety system, both safety outputs must be connected to the safety system. Configuring a safety system with only one safety output may result in serious injuries due to output circuit fault and a failure of the machine to stop.



Protection of Cable at Installation:
Care should be taken when installing the OS32C cable. The cable must be properly routed and secured to ensure that damage does not occur.



Functional Earth:

The OS32C system requires a functional earth connection.



Do not connect Functional Earth to a positive ground system. If it is connected to positive ground, the guarded machine to be controlled may NOT stop, resulting in severe operator injury.

Signal Connector Isolation:

The connectors used during installation must provide sufficient signal separation in order to prevent a short circuit condition of the input power and system signals.





CAUTION

When wiring the OS32C to external devices, make sure to follow the color and coding schemes per EN 60204-1.

Others

WARNING

Do not modify the main unit of the OS32C. Do not replace or fix any component of the OS32C other than the ones specified in this manual. Doing so may result in a failure of this device to function correctly. 

If there is any damage to the window, replace them as soon as possible. Otherwise it may result in a failure of the OS32C. Take preventive measures when performing replacement work so that dust does not enter the OS32C. 

Always detach all cables from the OS32C before replacing the scan window. Otherwise the motor may start rotating, resulting in injuries. 

The window replacement procedure must only be performed by qualified personnel in a clean environment at ambient temperature (5 to 35 °C) to prevent the internal optical surface from contamination. Make sure the inside and the outside of the replacement window is clean and free from scratch, dust, and finger print. 

The calibration procedure must only be performed by qualified personnel. Before performing window calibration of the new scan window, make sure the window is clean and free from scratch, dust, and finger print. The window calibration procedure must be performed at ambient temperature 5 to 35 °C. Failure to inspect the window or set the proper environmental condition during window calibration procedure may cause a reduction in the detection capability of the scanner. 

The tests outlined in this Test Procedure (Refer to OS32C Series User's Manual (Man.No.Z296-E1)) must be performed at time of installation, according to the employer's regular inspection program and after any maintenance, tooling change, set up, adjustment, or modification to the OS32C system or the guarded machine. Where a guarded machine is used by multiple operators or shifts, it is suggested that the test procedure be performed at each shift or operation change and also if there is a change in the OS32C operating mode or defined zone sets. Testing ensures that the safety laser scanner and the machine control system are working properly to stop the machine. Failure to test properly could result in serious injury to personnel. 

If the OS32C is operated under automatic start, make sure that the machine stops and does not restart as long as an object is detected in a safety zone. Check the operation by placing a test piece into the safety zone. It is recommended to perform the test at least after a shift change or 24 hours of operation. 

If the safety system or the machine fails any of these tests, do not run the machine. Immediately tag or lock out the machine to prevent its use and notify the appropriate supervisor. 

System and zone status parameters monitored over EtherNet/IP are to be used for diagnostic purposes only, and must not be used in safety-critical functions. 

Measurement data monitored over EtherNet/IP are to be used for diagnostic purposes only, and must not be used in safety-critical functions. 

CAUTION

When transferring data from the PC to the OS32C and more than one OS32C is connected to the network, it is necessary to visually check the diagnostic code on the status/diagnostic display. It is recommended that the OS32C be installed in a position where the status/diagnostic display will be visible. 

Before sending the changes to the sensor, verify that the safety parameters are configured as intended for the application. 

Take precautions to prevent dirt, dust or debris from entering the sensor and I/O block connectors. It is recommended that this be done on a clean workstation as contaminants may degrade the performance of the OS32C. 

Adhesion of dust to the scan window may cause a false operation. The OS32C will require periodic cleaning of the scan window and dust detection surface. 

Operation of the OS32C may be affected by light in the environment, such as incandescent light, strobe light and light from a photosensor using infrared light. 

Operation of the OS32C may be affected by substances in the environment, such as fog, smoke, steam and other small particles. 

Ensure the measurement report configuration matches the expected measurement data format. 

Configuration Tool Features and Compatibility

Refer to the table below for supported features and compatibility with OS32C versions. Refer to the product labels to determine the OS32C version.

NOTE:

- Only the version of the sensor block and the configuration tool were updated to support the new features. No changes were made to the I/O block.
- The window replacement kit OS32C-WIN-KT can be used on any sensor block.



The part numbers have changed:

OS32C-SN: 40591-0010 (old), 40591-0020 (current)

OS32C-SN-DM: 40591-0040 (current)

OS32C-SN-4M: 40603-0020 (current)

OS32C-SN-DM-4M: 40603-0040 (current)

	OS32C Version		OS32C-DM	OS32C-4M	OS32C-DM-4M
	40591-0010	40591-0020	40591-0040	40603-0020	40603-0040
✓: Supported					
Configurable minimum object resolution	--	✓	✓	✓	✓
Standby mode with laser shutoff	--	✓	✓	✓	✓
Copy & paste zones and zone sets	--	✓	✓	✓	✓
Record system monitoring	--	✓	✓	✓	✓
Playback system monitoring	--	✓	✓	✓	✓
Support for inverting 7-segment display	--	✓	✓	✓	✓
Display configuration filename in config tool header	--	✓	✓	✓	✓
Additional zone shapes (180° semi-circle, 180° rectangle, 180° polygon)	--	✓	✓	✓	✓
Config tool support for switching between default OS32C configuration and the user's current working configuration	--	✓	✓	✓	✓
Troubleshooting tips displayed in fault log	--	✓	✓	✓	✓
Configuration checksum, safety checksum	✓ *1	✓ *1	✓ *1	✓ *1	✓ *1
Windows 7 support	--	✓	✓	✓	✓
Non-safety checksum	✓ *2	✓ *2	✓ *2	✓ *2	✓ *2
Single Import & Export Zone Coordinate Data	✓ *2	✓ *2	✓ *2	✓ *2	✓ *2
Maintenance access level	--	✓ *3	✓ *2	✓ *2	✓ *2
Rotation of monitor screen view	✓ *4	✓ *4	✓ *4	✓ *4	✓ *4
French, German, Italian & Spanish Languages	✓ *4	✓ *4	✓ *4	✓ *4	✓ *4
Multiple Import & Export Zone Coordinate Data	✓ *4	✓ *4	✓ *4	✓ *4	✓ *4
EtherNet/IP and Measurement Data	--	--	✓	--	✓
Pollution Tolerance Mode	--	✓ *6	✓ *6	✓ *5	✓ *5
Variable response time settings	--	✓ *6	✓ *6	✓ *5	✓ *5
4 meter safety/ 15 meter warning zone	--	--	--	✓ *5	✓ *5
Status information during monitor mode	--	✓ *6	✓ *6	✓ *5	✓ *5
Confirmation of Safety parameters	--	✓ *6	✓ *6	✓ *5	✓ *5
Warning Zone changed via Ethernet/IP capability	--	--	✓ *6	--	✓ *5
Windows 10 support	--	✓ *7	✓ *7	✓ *7	✓ *7

OS32C

- *1. Requires Configuration Tool Version 1.4.0 and up
- *2. Requires Configuration Tool Version 1.6.0 and up
- *3. If serial number of the sensor block is higher than AS08300 and Configuration Tool is version 1.6.0 and up
- *4. Requires Configuration Tool is Version 1.8.0 and up
- *5. Requires Configuration Tool is Version 2.0.0 and up
- *6. If serial number of the sensor block is higher than AS17500 and Configuration Tool is Version 2.0.0 and up
- *7. Requires Configuration Tool Version 2.2.8 and up

	Configuration Tool Version					
	before 1.4.0	1.4.0 and up	1.6.0 and up	1.8.0 and up	2.0.0 and up	2.2.8 and up
✓: Supported						
Configurable minimum object resolution	--	✓	✓	✓	✓	✓
Standby mode with laser shutoff	--	✓	✓	✓	✓	✓
Copy & paste zones and zone sets	--	✓	✓	✓	✓	✓
Record system monitoring	--	✓	✓	✓	✓	✓
Playback system monitoring	--	✓	✓	✓	✓	✓
Support for inverting 7-segment display	--	✓	✓	✓	✓	✓
Display configuration filename in config tool header	--	✓	✓	✓	✓	✓
Additional zone shapes (180° semi-circle, 180° rectangle, 180° polygon)	--	✓	✓	✓	✓	✓
Config tool support for switching between default OS32C configuration and the user's current working configuration	--	✓	✓	✓	✓	✓
Troubleshooting tips displayed in fault log	--	✓	✓	✓	✓	✓
Configuration checksum, safety checksum	--	✓	✓	✓	✓	✓
Windows 7 support	--	✓	✓	✓	✓	✓
Non-safety checksum	--	--	✓	✓	✓	✓
Single Import & Export Zone Coordinate Data	--	--	✓	✓	✓	✓
Maintenance access level	--	--	✓	✓	✓	✓
Rotation of monitor screen view	--	--	--	✓	✓	✓
French, German, Italian & Spanish Languages	--	--	--	✓	✓	✓
Multiple Import & Export Zones Coordinate Data	--	--	--	✓	✓	✓
Pollution Tolerance Modes	--	--	--	--	✓	✓
Variable response time settings	--	--	--	--	✓	✓
4 meter safety/ 15 meter warning zone	--	--	--	--	✓	✓
Status information during monitor mode	--	--	--	--	✓	✓
Confirmation of Safety parameters	--	--	--	--	✓	✓
Warning Zone changed via Ethernet/IP capability	--	--	--	--	✓	✓
Windows 10 support	--	--	--	--	--	✓

Note: The configuration data file extension is *.cf2 until Configuration Tool Version 1.8.0 and *.cf3 from Version 2.0.0.

✓: Supported

Model	Sensor Head P/N	Configuration Tool Version				
		before 1.4.0	1.4.0 and up	1.6.0 and up	1.8.0 and up	2.0.0 and up
OS32C-SN	40591-0010	✓	✓	✓	✓	✓
OS32C-SN	40591-0020	--	✓	✓	✓	✓
OS32C-SN-DM	40591-0040	--	--	✓	✓	✓
OS32C-SN-4M	40603-0020	--	--	--	--	✓
OS32C-SN-DM-4M	40603-0040	--	--	--	--	✓

Terms and Conditions Agreement

Read and understand this catalog.

Please read and understand this catalog before purchasing the products. Please consult your OMRON representative if you have any questions or comments.

Warranties.

- (a) Exclusive Warranty. Omron's exclusive warranty is that the Products will be free from defects in materials and workmanship for a period of twelve months from the date of sale by Omron (or such other period expressed in writing by Omron). Omron disclaims all other warranties, express or implied.
- (b) Limitations. OMRON MAKES NO WARRANTY OR REPRESENTATION, EXPRESS OR IMPLIED, ABOUT NON-INFRINGEMENT, MERCHANTABILITY OR FITNESS FOR A PARTICULAR PURPOSE OF THE PRODUCTS. BUYER ACKNOWLEDGES THAT IT ALONE HAS DETERMINED THAT THE PRODUCTS WILL SUITABLY MEET THE REQUIREMENTS OF THEIR INTENDED USE.

Omron further disclaims all warranties and responsibility of any type for claims or expenses based on infringement by the Products or otherwise of any intellectual property right. (c) Buyer Remedy. Omron's sole obligation hereunder shall be, at Omron's election, to (i) replace (in the form originally shipped with Buyer responsible for labor charges for removal or replacement thereof) the non-complying Product, (ii) repair the non-complying Product, or (iii) repay or credit Buyer an amount equal to the purchase price of the non-complying Product; provided that in no event shall Omron be responsible for warranty, repair, indemnity or any other claims or expenses regarding the Products unless Omron's analysis confirms that the Products were properly handled, stored, installed and maintained and not subject to contamination, abuse, misuse or inappropriate modification. Return of any Products by Buyer must be approved in writing by Omron before shipment. Omron Companies shall not be liable for the suitability or unsuitability or the results from the use of Products in combination with any electrical or electronic components, circuits, system assemblies or any other materials or substances or environments. Any advice, recommendations or information given orally or in writing, are not to be construed as an amendment or addition to the above warranty.

See <http://www.omron.com/global/> or contact your Omron representative for published information.

Limitation on Liability; Etc.

OMRON COMPANIES SHALL NOT BE LIABLE FOR SPECIAL, INDIRECT, INCIDENTAL, OR CONSEQUENTIAL DAMAGES, LOSS OF PROFITS OR PRODUCTION OR COMMERCIAL LOSS IN ANY WAY CONNECTED WITH THE PRODUCTS, WHETHER SUCH CLAIM IS BASED IN CONTRACT, WARRANTY, NEGLIGENCE OR STRICT LIABILITY.

Further, in no event shall liability of Omron Companies exceed the individual price of the Product on which liability is asserted.

Suitability of Use.

Omron Companies shall not be responsible for conformity with any standards, codes or regulations which apply to the combination of the Product in the Buyer's application or use of the Product. At Buyer's request, Omron will provide applicable third party certification documents identifying ratings and limitations of use which apply to the Product. This information by itself is not sufficient for a complete determination of the suitability of the Product in combination with the end product, machine, system, or other application or use. Buyer shall be solely responsible for determining appropriateness of the particular Product with respect to Buyer's application, product or system. Buyer shall take application responsibility in all cases.

NEVER USE THE PRODUCT FOR AN APPLICATION INVOLVING SERIOUS RISK TO LIFE OR PROPERTY OR IN LARGE QUANTITIES WITHOUT ENSURING THAT THE SYSTEM AS A WHOLE HAS BEEN DESIGNED TO ADDRESS THE RISKS, AND THAT THE OMRON PRODUCT(S) IS PROPERLY RATED AND INSTALLED FOR THE INTENDED USE WITHIN THE OVERALL EQUIPMENT OR SYSTEM.

Programmable Products.

Omron Companies shall not be responsible for the user's programming of a programmable Product, or any consequence thereof.

Performance Data.

Data presented in Omron Company websites, catalogs and other materials is provided as a guide for the user in determining suitability and does not constitute a warranty. It may represent the result of Omron's test conditions, and the user must correlate it to actual application requirements. Actual performance is subject to the Omron's Warranty and Limitations of Liability.

Change in Specifications.

Product specifications and accessories may be changed at any time based on improvements and other reasons. It is our practice to change part numbers when published ratings or features are changed, or when significant construction changes are made. However, some specifications of the Product may be changed without any notice. When in doubt, special part numbers may be assigned to fix or establish key specifications for your application. Please consult with your Omron's representative at any time to confirm actual specifications of purchased Product.

Errors and Omissions.

Information presented by Omron Companies has been checked and is believed to be accurate; however, no responsibility is assumed for clerical, typographical or proofreading errors or omissions.

Note: Do not use this document to operate the Unit.

OMRON Corporation Industrial Automation Company

Tokyo, JAPAN

Contact: www.ia.omron.com

Regional Headquarters

OMRON EUROPE B.V.

Wegalaan 67-69, 2132 JD Hoofddorp
The Netherlands
Tel: (31)2356-81-300/Fax: (31)2356-81-388

OMRON SCIENTIFIC TECHNOLOGIES INC.

6550 Dumbarton Circle Fremont
CA 94555 U.S.A
Tel: (1) 510-608-3400/Fax: (1) 510-744-1442

OMRON ASIA PACIFIC PTE. LTD.

No. 438A Alexandra Road # 05-05/08 (Lobby 2),
Alexandra Technopark,
Singapore 119967
Tel: (65) 6835-3011/Fax: (65) 6835-2711

OMRON (CHINA) CO., LTD.

Room 2211, Bank of China Tower,
200 Yin Cheng Zhong Road,
PuDong New Area, Shanghai, 200120, China
Tel: (86) 21-5037-2222/Fax: (86) 21-5037-2200

Authorized Distributor:

© OMRON Corporation 2010-2014 All Rights Reserved.
In the interest of product improvement,
specifications are subject to change without notice.

CSM_14_3_0219

Cat. No. Z298-E1-04

0814(0510)